

12KP Series

Features

- 12000W peak pulse power capability at 10/1000 μ s waveform, repetition rate (duty cycle): 0.05%
- Fast response time
- Typical IR less than 2 μ A above 30V.
- High Temperature soldering guaranteed: 265 $^{\circ}$ C/10 seconds/.375" ,(9.5mm) lead length, 5lbs (2.3kg) tension
- Plastic package has underwriters laboratory flammability 94V-0
- Meets MSL level 1, per J-STD-020.
- Glass passivated junction
- Low incremental surge resistance
- Excellent clamping capability

Mechanical Data

- Case: Moulded plastic over glass passivated junction
- Terminal: Plated Axial leads, solderable per MIL-STD-750, Method 2026
- Polarity: Color band denotes cathode except bi-directional models
- Mounting Position: Any

- Weight: 2.30g

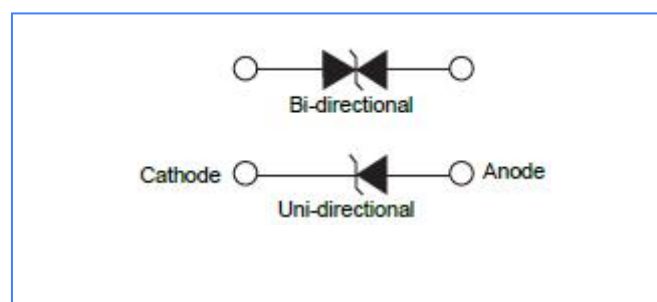
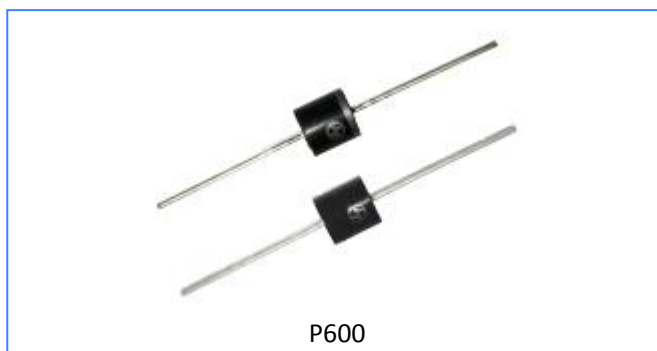

Maximum Ratings (TA=25 $^{\circ}$ C unless otherwise noted)

Parameter	Symbol	Value	Unit
Peak pulse power dissipation at 10/1000 μ s waveform(Note1, Fig.1)	P _{PPM}	Minimum 12000	Watts
Peak pulse current of at 10/1000 μ s waveform (Note 1, Fig.3)	I _{PPM}	See Table	Amps
Steady state power dissipation at TL=75 $^{\circ}$ C (Fig.5)	P _{M(AV)}	8.0	Watts
Peak forward surge current, 8.3ms single half sine-wave superimposed on rated load, (JEDEC Method) (Note2, Fig.6)	I _{FSM}	400	Amps
Operating junction and Storage Temperature Range.	T _J , T _{STG}	-55 to +175	$^{\circ}$ C
Typical thermal resistance junction to lead	R _{θJL}	8	$^{\circ}$ C/W
Typical thermal resistance junction to ambient	R _{θJA}	40	$^{\circ}$ C/W

Note:

1. Non-repetitive current pulse, per Fig.3 and derated above TA=25 $^{\circ}$ C per Fig.2.
2. 8.3ms single half sine-wave, or equivalent square wave, duty cycle=4 pulses per minutes maximum.

Electrical Characteristics (TA = 25 $^{\circ}$ C unless otherwise noted)

Part Number (Uni)	Part Number (Bi)	Reverse Stand off Voltage V_R (Volts)	Breakdown Voltage V_{BR} (Volts)@ I_T		Test Current I_T (mA)	Maximum Reverse Leakage I_R @ V_R (μ A)	Maximum Peak Pulse Current I_{pp} (A)	Maximum Clamping Voltage V_C @ I_{pp} (V)
			Min .V	Max .V				
12KP17A	12KP17CA	17	18.99	21.22	50	5000	409.6	29.3
12KP18A	12KP18CA	18	20.11	22.65	50	5000	388.3	30.9
12KP20A	12KP20CA	20	22.34	24.96	20	1500	349.9	34.3
12KP22A	12KP22CA	22	24.57	27.46	10	500	323.5	37.1
12KP24A	12KP24CA	24	26.81	29.95	5	150	294.8	40.7
12KP26A	12KP26CA	26	29.04	32.45	5	50	272.7	44.0
12KP28A	12KP28CA	28	31.28	34.95	5	25	252.6	47.5
12KP30A	12KP30CA	30	33.51	37.44	5	15	236.7	50.7
12KP33A	12KP33CA	33	36.90	41.19	5	2	219.4	54.7
12KP36A	12KP36CA	36	40.20	44.93	5	2	200.7	59.8
12KP40A	12KP40CA	40	44.70	49.92	5	2	182.4	65.8
12KP43A	12KP43CA	43	48.00	53.67	5	2	171.9	69.8
12KP45A	12KP45CA	45	50.30	56.16	5	2	164.8	72.8
12KP48A	12KP48CA	48	53.60	59.91	5	2	154.4	77.7
12KP51A	12KP51CA	51	57.00	63.65	5	2	144.8	82.9
12KP54A	12KP54CA	54	60.30	67.39	5	2	136.8	87.7
12KP58A	12KP58CA	58	64.80	72.39	5	2	127.9	93.8
12KP60A	12KP60CA	60	67.00	74.88	5	2	123.2	97.4
12KP64A	12KP64CA	64	71.50	79.87	5	2	115.2	104.2
12KP70A	12KP70CA	70	78.20	87.36	5	2	105.6	113.6
12KP75A	12KP75CA	75	83.80	93.60	5	2	98.4	122.0
12KP78A	12KP78CA	78	87.1	97.35	5	2	95.2	126.1
12KP85A	12KP85CA	85	94.90	106.08	5	2	87.2	137.6
12KP90A	12KP90CA	90	100.50	112.32	5	2	82.4	145.6
12KP100A	12KP100CA	100	111.70	124.80	5	2	74.4	161.3
12KP110A	12KP110CA	110	122.90	137.28	5	2	67.2	178.6
12KP120A	12KP120CA	120	134.00	149.76	5	2	62.4	192.3
12KP130A	12KP130CA	130	145.20	162.25	5	2	57.6	208.3
12KP150A	12KP150CA	150	167.60	187.21	5	2	49.6	241.9
12KP160A	12KP160CA	160	178.70	199.69	5	2	46.4	258.6
12KP170A	12KP170CA	170	189.90	212.17	5	2	44.0	272.7
12KP180A	12KP180CA	180	201.10	224.65	5	2	41.6	288.5
12KP200A	12KP200CA	200	223.40	249.61	5	2	37.6	319.1
12KP220A	12KP220CA	220	245.70	274.57	5	2	34.0	352.5
12KP240A	12KP240CA	240	268.10	299.53	5	2	31.2	384.6
12KP260A	12KP260CA	260	290.40	324.49	5	2	28.8	416.7
12KP280A	12KP280CA	280	312.80	349.45	5	2	26.4	454.5

Rating & Characteristic Curves

Figure 1- Peak Pulse Power Rating Curve

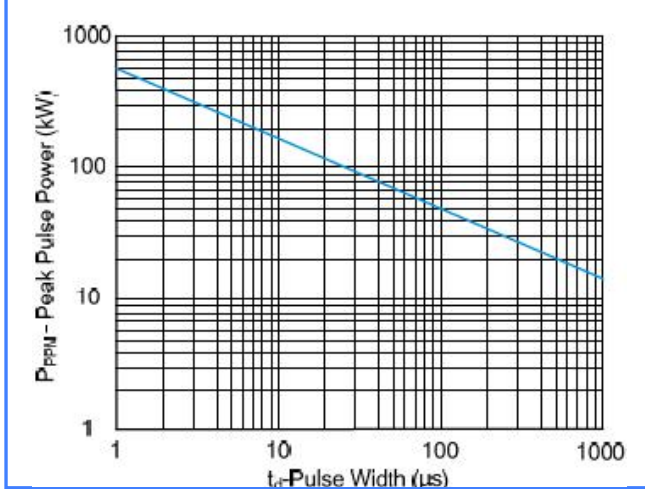

Figure 2- Pulse Derating Curve

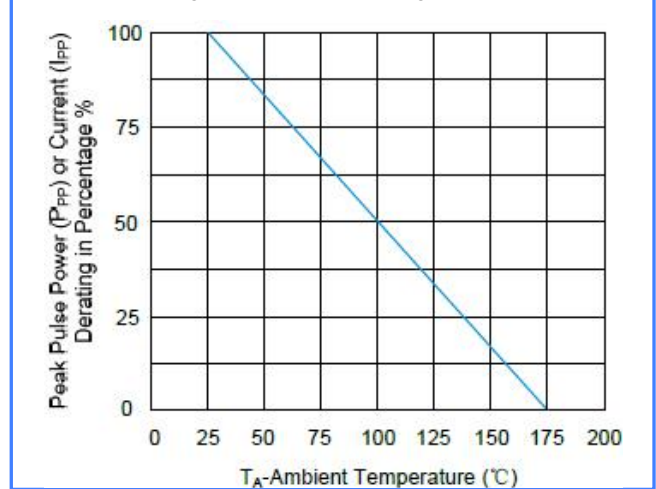

Figure 3- Pulse Waveform

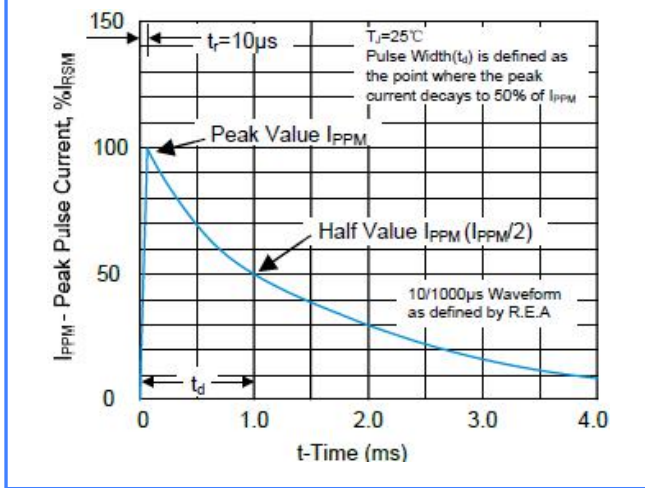

Figure 4- Typical Junction Capacitance

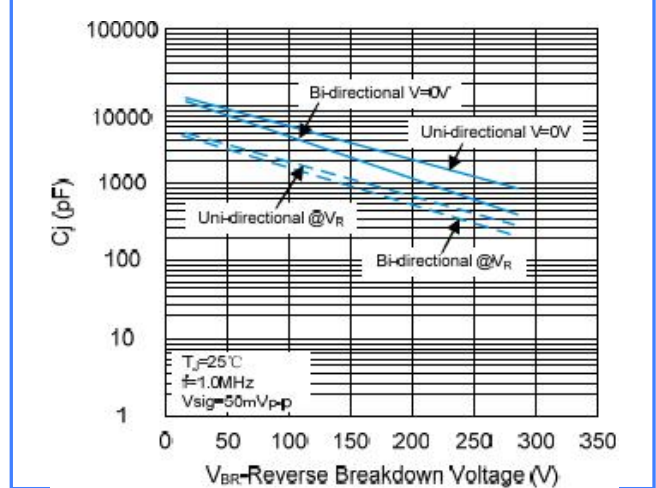

Figure 3- Steady State Power Dissipation Derating Curve

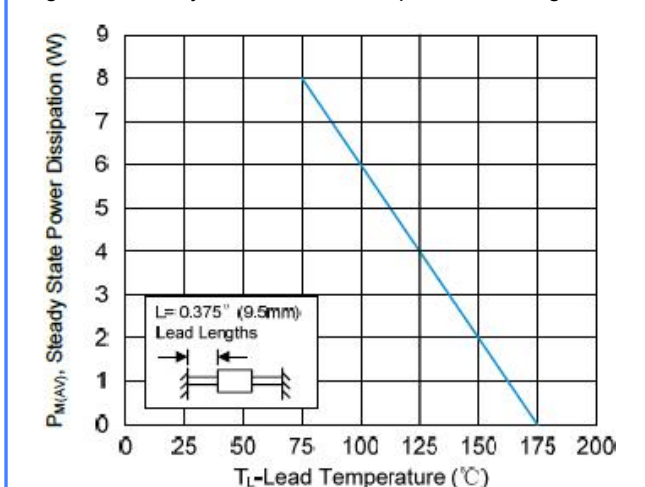
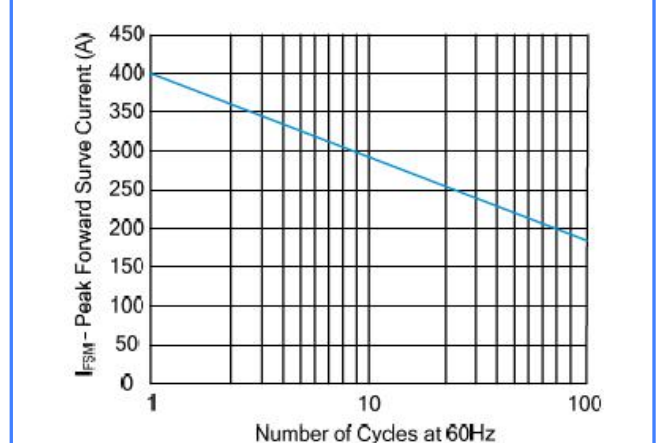
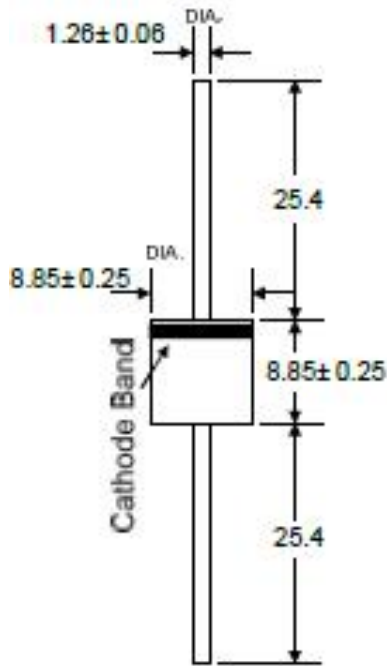

Figure 3- Maximum Non-Repetitive Forward Surge Current
Uni-Directional Only



PACKAGE OUTLINE DIMENSIONS in inches (millimeters)



Disclaimer

Specifications are subject to change without notice.

The device characteristics and parameters in this data sheet can and do vary in different applications and actual device performance may vary over time.

Users should verify actual device performance in their specific applications.