

AVX Surface Mount Ceramic Capacitor Products

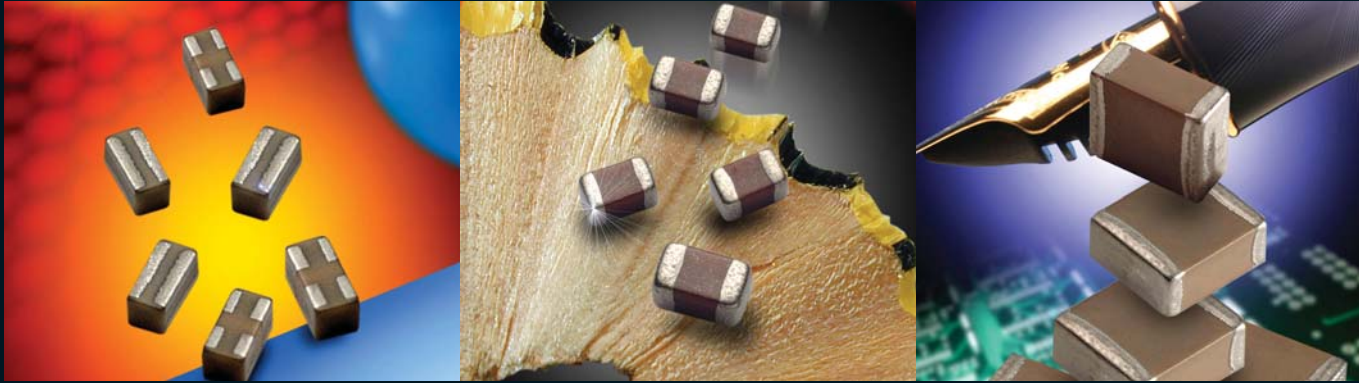

Version 9.4



Ceramic Chip Capacitors



Table of Contents

| | |
|---|--------------|
| How to Order - AVX Part Number Explanation | 2-3 |
| C0G (NP0) Dielectric | |
| General Specifications | 4 |
| Specifications and Test Methods | 5 |
| Capacitance Range | 6-7 |
| U Dielectric | |
| RF/Microwave C0G (NP0) Capacitors (RoHS) General Information and Capacitance Range | 8-10 |
| RF/Microwave C0G (NP0) Capacitors (Sn/Pb) General Information and Capacitance Range | 11-12 |
| Designer Kits | 13 |
| X8R Dielectric | |
| General Specifications | 14-15 |
| X7R Dielectric | |
| General Specifications | 16 |
| Specifications and Test Methods | 17 |
| Capacitance Range | 18-19 |
| X7S Dielectric | |
| General Specifications | 20 |
| Specifications and Test Methods | 21 |
| Capacitance Range | 22 |
| X5R Dielectric | |
| General Specifications | 23 |
| Specifications and Test Methods | 24 |
| Capacitance Range | 25 |
| Y5V Dielectric | |
| General Specifications | 26 |
| Specifications and Test Methods | 27 |
| Capacitance Range | 28 |
| MLCC Tin/Lead Termination (LD Series) | |
| General Specifications | 29 |
| Capacitance Range | 30-35 |
| MLCC Low Profile | |
| General Specifications / Capacitance Range | 36 |
| UltraThin Ceramic Capacitors | |
| General Specifications | 37 |
| Automotive MLCC | |
| General Specifications | 38-39 |
| Capacitance Range | 40-42 |
| APS for COTS+ Applications | |
| General Specifications | 43 |
| Capacitance Range | 44-45 |
| MLCC with FLEXITERM® | |
| General Description | 46 |
| Specifications and Test Methods | 47-48 |
| Capacitance Range | 49-50 |
| FLEXISAFE MLC Chips | |
| General Specifications and Capacitance Range | 51 |
| Capacitor Array | |
| Capacitor Array (IPC) | 52-55 |
| Automotive Capacitor Array (IPC) | 56 |
| Multi-Value Capacitor Array (IPC) | 57 |
| Part and Pad Layout Dimensions | 58 |
| Low Inductance Capacitors | |
| Introduction | 59-60 |
| LICC (Low Inductance Chip Capacitors) | 61-64 |
| IDC (InterDigitated Capacitors) | 65-68 |
| LGA Low Inductance Capacitors | 69-70 |
| LICA (Low Inductance Decoupling Capacitor Arrays) | 71-72 |
| High Voltage MLC Chips | |
| 600V to 5000V Applications | 73-74 |
| Tin/Lead Termination "B" - 600V to 5000V Applications | 75-76 |
| MIL-PRF-55681/Chips | |
| CDR01 thru CDR06 | 77-78 |
| CDR31 thru CDR35 | 79-82 |
| Packaging of Chip Components | 83 |
| Embossed Carrier Configuration - 8 & 12mm Tape | 84 |
| Paper Carrier Configuration - 8 & 12mm Tape | 85 |
| Bulk Case Packaging | 86 |
| Basic Capacitor Formulas | 87 |
| General Description | 88-92 |
| Surface Mounting Guide | 93-97 |



How to Order

Part Number Explanation

Commercial Surface Mount Chips

EXAMPLE: 08055A101JAT2A

| 0805 | 5 | A | 101 | J* | A | T | 2 | A | |
|--|---|---|--|--|---------------------------|---|---|--|--|
| Size (L" x W") | Voltage | Dielectric | Capacitance | Tolerance | Failure Rate | Terminations | Packaging | Special Code | |
| 0201 0402 0603 0805 1206 1210 1812 1825 2220 2225 | 4 = 4V 6 = 6.3V Z = 10V Y = 16V 3 = 25V D = 35V 5 = 50V 1 = 100V 2 = 200V 7 = 500V | A = NP0(C0G) C = X7R D = X5R F = X8R G = Y5V U = U Series W = X6S Z = X7S | 2 Sig. Fig + No. of Zeros Examples: 100 = 10 pF 101 = 100 pF 102 = 1000 pF 223 = 22000 pF 224 = 220000 pF 105 = 1µF 106 = 10µF 107 = 100µF For values below 10 pF, use "R" in place of Decimal point, e.g., 9.1 pF = 9R1. | B = ±.10 pF C = ±.25 pF D = ±.50 pF F = ±1% (≥ 10 pF) G = ±2% (≥ 10 pF) J = ±5% K = ±10% M = ±20% Z = +80%, -20% P = +100%, -0% | A = N/A 4 = Automotive | T = Plated Ni and Sn 7 = Gold Plated U = Conductive Expoxy for Hybrid Applications Z = FLEXITERM® X = FLEXITERM® with 5% min lead (X7R & X8R only) | <u>Available</u> 2 = 7" Reel 4 = 13" Reel 7 = Bulk Cass. 9 = Bulk | A = Std. | |
| | | Contact Factory for Special Voltages F = 63V 9 = 300V * = 75V X = 350V E = 150V 8 = 400V V = 250V | | | | Contact Factory For 1 = Pd/Ag Term | | Contact Factory For Multiples | |

* B, C & D tolerance for ≤10 pF values.
 Standard Tape and Reel material (Paper/Embossed) depends upon chip size and thickness.
 See individual part tables for tape material type for each capacitance value.

NOTE: Contact factory for availability of Termination and Tolerance Options for Specific Part Numbers.
 For Tin/Lead Terminations, please refer to LD Series

High Voltage MLC Chips

EXAMPLE: 1808AA271KA11A

| 1808 | A | A | 271 | K | A | T | 1 | A |
|--|--|--------------------------------|---|--|---------------------|---|---|---------------------|
| AVX Style | Voltage | Temperature Coefficient | Capacitance Code | Capacitance Tolerance | Failure Rate | Termination | Packaging/ Marking | Special Code |
| 0805 1206 1210 1808 1812 1825 2220 2225 3640 | C = 600V/630V A = 1000V S = 1500V G = 2000V W = 2500V H = 3000V J = 4000V K = 5000V | A = C0G C = X7R | (2 significant digits + no. of zeros) Examples: 10 pF = 100 100 pF = 101 1,000 pF = 102 22,000 pF = 223 220,000 pF = 224 1 µF = 105 | C0G: J = ±5% K = ±10% M = ±20% X7R: K = ±10% M = ±20% Z = +80%, -20% | A=Not Applicable | 1 = Pd/Ag T = Plated Ni and Sn B = 5% Min Pb Z = FLEXITERM® X = FLEXITERM® with 5% min lead (X7R only) | 1 = 7" Reel 3 = 13" Reel 9 = Bulk | A = Standard |

NOTE: Contact factory for availability of Termination and Tolerance Options for Specific Part Numbers.
 For Tin/Lead Terminations, please refer to LD Series

How to Order

Part Number Explanation

Capacitor Array

EXAMPLE: W2A43C103MAT2A

| W | 2 | A | 4 | 3 | C | 103 | M | A | T | 2A |
|--------------------------------------|--|--------------|-----------------------|--|--|---|---|---|---|---|
| Style W = RoHS L = SnPb | Case Size 1 = 0405 2 = 0508 3 = 0612 | Array | Number of Caps | Voltage Z = 10V Y = 16V 3 = 25V 5 = 50V 1 = 100V | Dielectric A = NP0 C = X7R D = X5R | Capacitance Code (In pF) 2 Sig Digits + Number of Zeros | Capacitance Tolerance J = ±5% K = ±10% M = ±20% | Failure Rate A = Commercial 4 = Automotive | Termination Code T = Plated Ni and Sn Z = FLEXITERM® B = 5% min lead X = FLEXITERM® with 5% min lead | Packaging & Quantity Code 2A = 7" Reel (4000) 4A = 13" Reel (10000) 2F = 7" Reel (1000) |

NOTE: Contact factory for availability of Termination and Tolerance Options for Specific Part Numbers.

Low Inductance Capacitors (LICC)

EXAMPLE: 0612ZD105MAT2A

| 0612 | Z | D | 105 | M | A | T | 2 | A |
|---|--|---|--|--|--------------------------------|--|---|---|
| Size 0306 0508 0612 LD16 LD17 LD18 | Voltage 6 = 6.3V Z = 10V Y = 16V 3 = 25V 5 = 50V | Dielectric C = X7R D = X5R | Capacitance Code (In pF) 2 Sig. Digits + Number of Zeros | Capacitance Tolerance K = ±10% M = ±20% | Failure Rate A = N/A | Terminations T = Plated Ni and Sn B = 5% min lead | Packaging Available 2 = 7" Reel 4 = 13" Reel | Thickness See Page 64 for Codes |

NOTE: Contact factory for availability of Termination and Tolerance Options for Specific Part Numbers.

Interdigitated Capacitors (IDC)

EXAMPLE: W3L16D225MAT3A

| W | 3 | L | 1 | 6 | D | 225 | M | A | T | 3 | A |
|--------------------------------------|--|---|---|--|---|--|--|--------------------------------|---|---|---|
| Style W = RoHS L = SnPb | Case Size 2 = 0508 3 = 0612 | Low Inductance ESL = 50pH ESL = 60pH | Number of Terminals 1 = 8 Terminals | Voltage 4 = 4V 6 = 6.3V Z = 10V Y = 16V | Dielectric C = X7R D = X5R | Capacitance Code (In pF) 2 Sig. Digits + Number of Zeros | Capacitance Tolerance M = ±20% | Failure Rate A = N/A | Termination T = Plated Ni and Sn B = 5% min Lead | Packaging Available 1=7" Reel 3=13" Reel | Thickness Max. Thickness mm (in.) A=0.95 (0.037) S=0.55 (0.022) |

NOTE: Contact factory for availability of Termination and Tolerance Options for Specific Part Numbers.

Low Inductance Decoupling Capacitor Arrays (LICA)

EXAMPLE: LICA3T183M3FC4AA

| LICA | 3 | T | 102 | M | 3 | F | C | 4 | A | A |
|---|--|--|---|---|---|--|--|---|---|--|
| Style & Size 5V = 9 10V = Z 25V = 3 | Voltage 5V = 9 10V = Z 25V = 3 | Dielectric D = X5R T = T55T S = High K T55T | Cap/Section (EIA Code) 102 = 1000 pF 103 = 10 nF 104 = 100 nF | Capacitance Tolerance M = ±20% P = GMV | Height Code 6 = 0.500mm 3 = 0.650mm 1 = 0.875mm 5 = 1.100mm 7 = 1.600mm | Termination F = C4 Solder Balls- 97Pb/3Sn H = C4 Solder Balls-Low ESR P = Cr-Cu-Au N = Cr-Ni-Au X = None | Reel Packaging M = 7" Reel R = 13" Reel 6 = 2"x2" Waffle Pack 8 = 2"x2" Black Waffle Pack 7 = 2"x2" Waffle Pack w/ termination facing up A = 2"x2" Black Waffle Pack w/ termination facing up C = 4"x4" Waffle Pack w/ clear lid | # of Caps/Part 1 = one 2 = two 4 = four | Inspection Code A = Standard B = Established Reliability Testing | Code Face A = Bar B = No Bar C = Dot, S55S Dielectrics D = Triangle |

NOTE: Contact factory for availability of Termination and Tolerance Options for Specific Part Numbers.

C0G (NP0) Dielectric



General Specifications

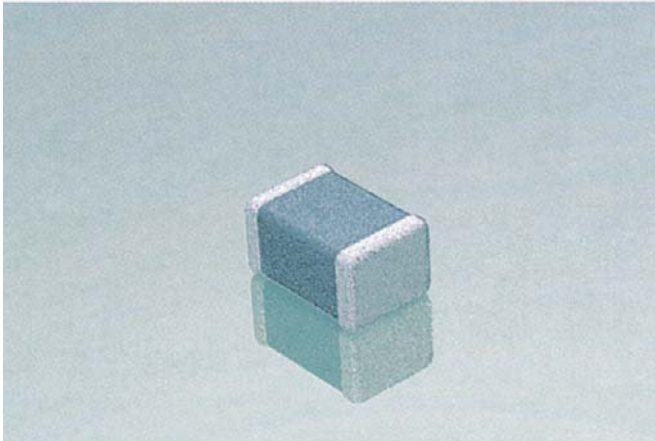

C0G (NP0) is the most popular formulation of the “temperature-compensating,” EIA Class I ceramic materials. Modern C0G (NP0) formulations contain neodymium, samarium and other rare earth oxides.

C0G (NP0) ceramics offer one of the most stable capacitor dielectrics available. Capacitance change with temperature is $0 \pm 30 \text{ ppm}/^\circ\text{C}$ which is less than $\pm 0.3\% \Delta C$ from -55°C to $+125^\circ\text{C}$. Capacitance drift or hysteresis for C0G (NP0) ceramics is negligible at less than $\pm 0.05\%$ versus up to $\pm 2\%$ for films. Typical capacitance change with life is less than $\pm 0.1\%$ for C0G (NP0), one-fifth that shown by most other dielectrics. C0G (NP0) formulations show no aging characteristics.

PART NUMBER (see page 2 for complete part number explanation)

0805

Size
(L" x W")

5

Voltage
6.3V = 6
10V = Z
16V = Y
25V = 3
50V = 5
100V = 1
200V = 2
500V = 7

A

Dielectric
C0G (NP0) = A

101

Capacitance Code (In pF)
2 Sig. Digits +
Number of
Zeros

J

Capacitance Tolerance
B = $\pm 10 \text{ pF}$ ($< 10 \text{ pF}$)
C = $\pm 25 \text{ pF}$ ($< 10 \text{ pF}$)
D = $\pm 50 \text{ pF}$ ($< 10 \text{ pF}$)
F = $\pm 1\%$ ($\geq 10 \text{ pF}$)
G = $\pm 2\%$ ($\geq 10 \text{ pF}$)
J = $\pm 5\%$
K = $\pm 10\%$

A

Failure Rate
A = Not
Applicable

T

Terminations
T = Plated Ni
and Sn
7 = Gold Plated

2

Packaging
2 = 7" Reel
4 = 13" Reel
7 = Bulk Cass.
9 = Bulk

A

Special Code
A = Std.
Product

Contact Factory For
1 = Pd/Ag Term

Contact Factory For
Multiples

NOTE: Contact factory for availability of Termination and Tolerance Options for Specific Part Numbers.
Contact factory for non-specified capacitance values.

Temperature Coefficient

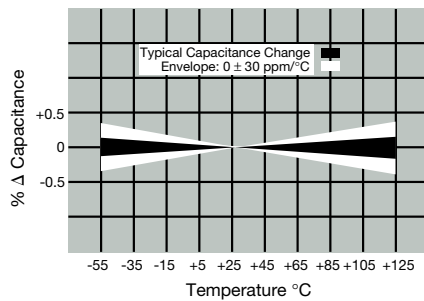

Δ Capacitance vs. Frequency

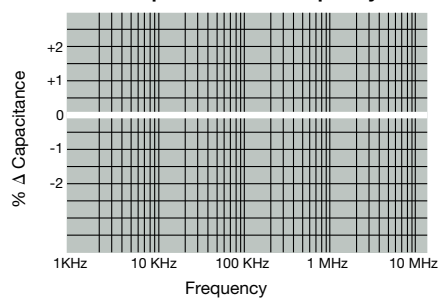

Insulation Resistance vs Temperature

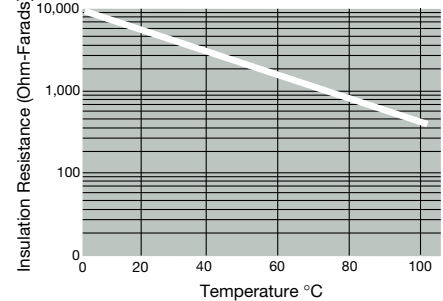

Variation of Impedance with Cap Value
Impedance vs. Frequency
0805 - C0G (NP0)
10 pF vs. 100 pF vs. 1000 pF

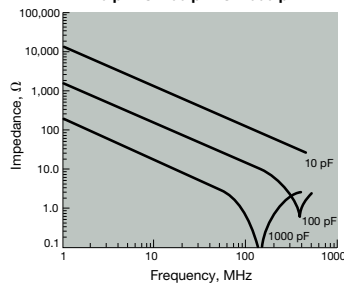

Variation of Impedance with Chip Size
Impedance vs. Frequency
1000 pF - C0G (NP0)

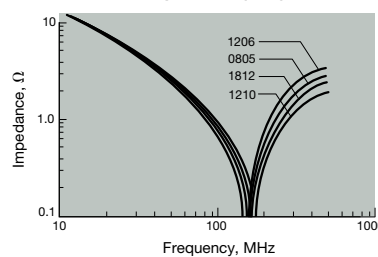

Variation of Impedance with Ceramic Formulation
Impedance vs. Frequency
1000 pF - C0G (NP0) vs X7R
0805

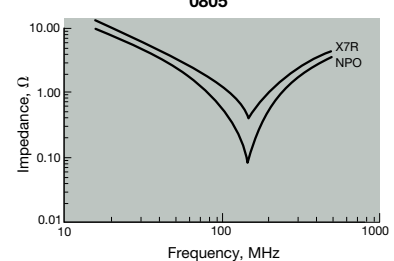

COG (NP0) Dielectric

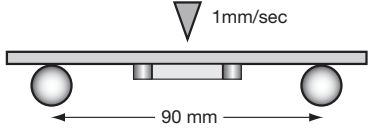

Specifications and Test Methods

| Parameter/Test | | NP0 Specification Limits | Measuring Conditions | |
|--------------------------------|-----------------------|---|--|--|
| Operating Temperature Range | | -55°C to +125°C | Temperature Cycle Chamber | |
| Capacitance | | Within specified tolerance | Freq.: 1.0 MHz ± 10% for cap ≤ 1000 pF 1.0 kHz ± 10% for cap > 1000 pF Voltage: 1.0Vrms ± .2V | |
| Q | | <30 pF: Q ≥ 400+20 x Cap Value ≥30 pF: Q ≥ 1000 | | |
| Insulation Resistance | | 100,000MΩ or 1000MΩ - μF, whichever is less | Charge device with rated voltage for 60 ± 5 secs @ room temp/humidity | |
| Dielectric Strength | | No breakdown or visual defects | Charge device with 300% of rated voltage for 1-5 seconds, w/charge and discharge current limited to 50 mA (max) Note: Charge device with 150% of rated voltage for 500V devices. | |
| Resistance to Flexure Stresses | Appearance | No defects | Deflection: 2mm Test Time: 30 seconds | |
| | Capacitance Variation | ±5% or ±.5 pF, whichever is greater | 1mm/sec | |
| | Q | Meets Initial Values (As Above) |  | |
| | Insulation Resistance | ≥ Initial Value x 0.3 | | |
| Solderability | | ≥ 95% of each terminal should be covered with fresh solder | Dip device in eutectic solder at 230 ± 5°C for 5.0 ± 0.5 seconds | |
| Resistance to Solder Heat | Appearance | No defects, <25% leaching of either end terminal | Dip device in eutectic solder at 260°C for 60 seconds. Store at room temperature for 24 ± 2 hours before measuring electrical properties. | |
| | Capacitance Variation | ≤ ±2.5% or ±.25 pF, whichever is greater | | |
| | Q | Meets Initial Values (As Above) | | |
| | Insulation Resistance | Meets Initial Values (As Above) | | |
| Thermal Shock | Dielectric Strength | Meets Initial Values (As Above) | Step 1: -55°C ± 2° 30 ± 3 minutes | |
| | Appearance | No visual defects | Step 2: Room Temp ≤ 3 minutes | |
| | Capacitance Variation | ≤ ±2.5% or ±.25 pF, whichever is greater | Step 3: +125°C ± 2° 30 ± 3 minutes | |
| | Q | Meets Initial Values (As Above) | Step 4: Room Temp ≤ 3 minutes | |
| | Insulation Resistance | Meets Initial Values (As Above) | Repeat for 5 cycles and measure after 24 hours at room temperature | |
| Load Life | Dielectric Strength | Meets Initial Values (As Above) | Charge device with twice rated voltage in test chamber set at 125°C ± 2°C for 1000 hours (+48, -0). Remove from test chamber and stabilize at room temperature for 24 hours before measuring. | |
| | Appearance | No visual defects | | |
| | Capacitance Variation | ≤ ±3.0% or ± .3 pF, whichever is greater | | |
| | Q (C=Nominal Cap) | ≥ 30 pF: Q ≥ 350 ≥10 pF, <30 pF: Q ≥ 275 +5C/2 <10 pF: Q ≥ 200 +10C | | |
| Load Humidity | Insulation Resistance | ≥ Initial Value x 0.3 (See Above) | Store in a test chamber set at 85°C ± 2°C/ 85% ± 5% relative humidity for 1000 hours (+48, -0) with rated voltage applied. Remove from chamber and stabilize at room temperature for 24 ± 2 hours before measuring. | |
| | Dielectric Strength | Meets Initial Values (As Above) | | |
| | Appearance | No visual defects | | |
| | Capacitance Variation | ≤ ±5.0% or ± .5 pF, whichever is greater | | |
| Load Humidity | Q | ≥ 30 pF: Q ≥ 350 ≥10 pF, <30 pF: Q ≥ 275 +5C/2 <10 pF: Q ≥ 200 +10C | | |
| | Insulation Resistance | ≥ Initial Value x 0.3 (See Above) | | |
| | Dielectric Strength | Meets Initial Values (As Above) | | |
| | Appearance | No visual defects | | |

COG (NP0) Dielectric



Capacitance Range

PREFERRED SIZES ARE SHADED

| SIZE | 0201 | | 0402 | | | 0603 | | | | 0805 | | | | | 1206 | | | | | |
|--------------|-------------|--------------------------------|--------------------------------|--------------|------------------|--------------------------------|---|---|---|--------------------------------|---|---|---|---|--------------------------------|---|---|---|---|---|
| Soldering | Reflow Only | | Reflow/Wave | | | Reflow/Wave | | | | Reflow/Wave | | | | | Reflow/Wave | | | | | |
| Packaging | All Paper | | All Paper | | | All Paper | | | | Paper/Embossed | | | | | Paper/Embossed | | | | | |
| (L) Length | mm | 0.60 ± 0.03 (0.024 ± 0.001) | 1.00 ± 0.10 (0.040 ± 0.004) | | | 1.60 ± 0.15 (0.063 ± 0.006) | | | | 2.01 ± 0.20 (0.079 ± 0.008) | | | | | 3.20 ± 0.20 (0.126 ± 0.008) | | | | | |
| (W) Width | mm | 0.30 ± 0.03 (0.011 ± 0.001) | 0.50 ± 0.10 (0.020 ± 0.004) | | | 0.81 ± 0.15 (0.032 ± 0.006) | | | | 1.25 ± 0.20 (0.049 ± 0.008) | | | | | 1.60 ± 0.20 (0.063 ± 0.008) | | | | | |
| (t) Terminal | mm | 0.15 ± 0.05 (0.006 ± 0.002) | 0.25 ± 0.15 (0.010 ± 0.006) | | | 0.35 ± 0.15 (0.014 ± 0.006) | | | | 0.50 ± 0.25 (0.020 ± 0.010) | | | | | 0.50 ± 0.25 (0.020 ± 0.010) | | | | | |
| WVDC | | 25 50 | 16 25 50 | 16 25 50 100 | 16 25 50 100 200 | 16 25 50 100 200 500 | | | | | | | | | | | | | | |
| Cap (pF) | 0.5 | A | C | C | C | G | G | G | G | J | J | J | J | J | J | J | J | J | J | J |
| | 1.0 | A | C | C | C | G | G | G | G | J | J | J | J | J | J | J | J | J | J | J |
| | 1.2 | A | C | C | C | G | G | G | G | J | J | J | J | J | J | J | J | J | J | J |
| | 1.5 | A | A | C | C | C | G | G | G | J | J | J | J | J | J | J | J | J | J | J |
| | 1.8 | A | A | C | C | C | G | G | G | J | J | J | J | J | J | J | J | J | J | J |
| | 2.2 | A | A | C | C | C | G | G | G | J | J | J | J | J | J | J | J | J | J | J |
| | 2.7 | A | A | C | C | C | G | G | G | J | J | J | J | J | J | J | J | J | J | J |
| | 3.3 | A | A | C | C | C | G | G | G | J | J | J | J | J | J | J | J | J | J | J |
| | 3.9 | A | A | C | C | C | G | G | G | J | J | J | J | J | J | J | J | J | J | J |
| | 4.7 | A | A | C | C | C | G | G | G | J | J | J | J | J | J | J | J | J | J | J |
| | 5.6 | A | A | C | C | C | G | G | G | J | J | J | J | J | J | J | J | J | J | J |
| | 6.8 | A | A | C | C | C | G | G | G | J | J | J | J | J | J | J | J | J | J | J |
| | 8.2 | A | A | C | C | C | G | G | G | J | J | J | J | J | J | J | J | J | J | J |
| | 10 | A | A | C | C | C | G | G | G | J | J | J | J | J | J | J | J | J | J | J |
| | 12 | A | A | C | C | C | G | G | G | J | J | J | J | J | J | J | J | J | J | J |
| | 15 | A | A | C | C | C | G | G | G | J | J | J | J | J | J | J | J | J | J | J |
| | 18 | A | A | C | C | C | G | G | G | J | J | J | J | J | J | J | J | J | J | J |
| | 22 | A | A | C | C | C | G | G | G | J | J | J | J | J | J | J | J | J | J | J |
| | 27 | A | A | C | C | C | G | G | G | J | J | J | J | J | J | J | J | J | J | J |
| | 33 | A | A | C | C | C | G | G | G | J | J | J | J | J | J | J | J | J | J | J |
| | 39 | A | A | C | C | C | G | G | G | J | J | J | J | J | J | J | J | J | J | J |
| | 47 | A | A | C | C | C | G | G | G | J | J | J | J | J | J | J | J | J | J | J |
| | 56 | A | A | C | C | C | G | G | G | J | J | J | J | J | J | J | J | J | J | J |
| | 68 | A | A | C | C | C | G | G | G | J | J | J | J | J | J | J | J | J | J | J |
| | 82 | A | A | C | C | C | G | G | G | J | J | J | J | J | J | J | J | J | J | J |
| | 100 | A | A | C | C | C | G | G | G | J | J | J | J | J | J | J | J | J | J | J |
| | 120 | | | C | C | C | G | G | G | J | J | J | J | J | J | J | J | J | J | J |
| | 150 | | | C | C | C | G | G | G | J | J | J | J | J | J | J | J | J | J | J |
| | 180 | | | C | C | C | G | G | G | J | J | J | J | J | J | J | J | J | J | J |
| | 220 | | | C | C | C | G | G | G | J | J | J | J | J | J | J | J | J | J | M |
| | 270 | | | C | C | C | G | G | G | J | J | J | J | J | M | J | J | J | J | M |
| | 330 | | | C | C | C | G | G | G | J | J | J | J | J | M | J | J | J | J | M |
| | 390 | | | C | C | C | G | G | G | J | J | J | J | J | M | J | J | J | J | M |
| | 470 | | | C | C | C | G | G | G | J | J | J | J | J | M | J | J | J | J | M |
| | 560 | | | | | | G | G | G | J | J | J | J | J | M | J | J | J | J | M |
| | 680 | | | | | | G | G | G | J | J | J | J | J | | J | J | J | J | P |
| | 820 | | | | | | G | G | G | J | J | J | J | J | | J | J | J | J | M |
| | 1000 | | | | | | G | G | G | J | J | J | J | J | | J | J | J | J | Q |
| | 1200 | | | | | | | | | J | J | J | J | J | | J | J | J | J | Q |
| | 1500 | | | | | | | | | J | J | J | J | J | | J | J | J | M | Q |
| | 1800 | | | | | | | | | J | J | J | J | J | | J | J | M | M | |
| | 2200 | | | | | | | | | J | J | J | N | | J | J | M | P | | |
| | 2700 | | | | | | | | | J | J | N | | | J | J | M | P | | |
| | 3300 | | | | | | | | | J | J | | | | J | J | M | P | | |
| | 3900 | | | | | | | | | J | J | | | | J | J | M | P | | |
| | 4700 | | | | | | | | | J | J | | | | J | J | M | P | | |
| | 5600 | | | | | | | | | | | | | | J | J | M | | | |
| | 6800 | | | | | | | | | | | | | | J | J | M | | | |
| | 8200 | | | | | | | | | | | | | | J | J | M | | | |
| Cap (µF) | 0.010 | | | | | | | | | | | | | | M | M | | | | |
| | 0.012 | | | | | | | | | | | | | | M | M | | | | |
| | 0.015 | | | | | | | | | | | | | | | | | | | |
| | 0.018 | | | | | | | | | | | | | | | | | | | |
| | 0.022 | | | | | | | | | | | | | | | | | | | |
| | 0.027 | | | | | | | | | | | | | | | | | | | |
| | 0.033 | | | | | | | | | | | | | | | | | | | |
| | 0.039 | | | | | | | | | | | | | | | | | | | |
| | 0.047 | | | | | | | | | | | | | | | | | | | |
| | 0.068 | | | | | | | | | | | | | | | | | | | |
| | 0.082 | | | | | | | | | | | | | | | | | | | |
| | 0.1 | | | | | | | | | | | | | | | | | | | |
| WVDC | | 25 50 | 16 25 50 | 16 25 50 100 | 16 25 50 100 200 | 16 25 50 100 200 500 | | | | | | | | | | | | | | |

| Letter | A | C | E | G | J | K | M | N | P | Q | X | Y | Z |
|----------------|-----------------|-----------------|-----------------|-----------------|-----------------|-----------------|-----------------|-----------------|-----------------|-----------------|-----------------|-----------------|-----------------|
| Max. Thickness | 0.33 (0.013) | 0.56 (0.022) | 0.71 (0.028) | 0.90 (0.035) | 0.94 (0.037) | 1.02 (0.040) | 1.27 (0.050) | 1.40 (0.055) | 1.52 (0.060) | 1.78 (0.070) | 2.29 (0.090) | 2.54 (0.100) | 2.79 (0.110) |
| | PAPER | | | | | EMBOSSSED | | | | | | | |

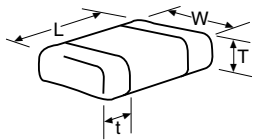

COG (NP0) Dielectric



Capacitance Range

PREFERRED SIZES ARE SHADED

| SIZE | | 1210 | | | | | 1812 | | | | | 1825 | | | | | 2220 | | | | | 2225 | | | | |
|----------------|-------------|--------------------------------|-----------------|-----------------|-----------------|-----------------|--------------------------------|-----------------|-----------------|-----------------|-----------------|--------------------------------|-----------------|-----------------|----|-----|--------------------------------|----|-----|-----|----|--------------------------------|-----|--|--|--|
| Soldering | | Reflow Only | | | | | Reflow Only | | | | | Reflow Only | | | | | Reflow Only | | | | | Reflow Only | | | | |
| Packaging | | Paper/Embossed | | | | | All Embossed | | | | | All Embossed | | | | | All Embossed | | | | | All Embossed | | | | |
| (L) Length | mm (in.) | 3.20 ± 0.20 (0.126 ± 0.008) | | | | | 4.50 ± 0.30 (0.177 ± 0.012) | | | | | 4.50 ± 0.30 (0.177 ± 0.012) | | | | | 5.70 ± 0.40 (0.225 ± 0.016) | | | | | 5.72 ± 0.25 (0.225 ± 0.010) | | | | |
| (W) Width | mm (in.) | 2.50 ± 0.20 (0.098 ± 0.008) | | | | | 3.20 ± 0.20 (0.126 ± 0.008) | | | | | 6.40 ± 0.40 (0.252 ± 0.016) | | | | | 5.00 ± 0.40 (0.197 ± 0.016) | | | | | 6.35 ± 0.25 (0.250 ± 0.010) | | | | |
| (t) Terminal | mm (in.) | 0.50 ± 0.25 (0.020 ± 0.010) | | | | | 0.61 ± 0.36 (0.024 ± 0.014) | | | | | 0.61 ± 0.36 (0.024 ± 0.014) | | | | | 0.64 ± 0.39 (0.025 ± 0.015) | | | | | 0.64 ± 0.39 (0.025 ± 0.015) | | | | |
| WVDC | | 25 | 50 | 100 | 200 | 500 | 25 | 50 | 100 | 200 | 500 | 50 | 100 | 200 | 50 | 100 | 200 | 50 | 100 | 200 | 50 | 100 | 200 | | | |
| Cap (pF) | 0.5 | | | | | | | | | | | | | | | | | | | | | | | | | |
| | 1.0 | | | | | | | | | | | | | | | | | | | | | | | | | |
| | 1.2 | | | | | | | | | | | | | | | | | | | | | | | | | |
| | 1.5 | | | | | | | | | | | | | | | | | | | | | | | | | |
| | 1.8 | | | | | | | | | | | | | | | | | | | | | | | | | |
| | 2.2 | | | | | | | | | | | | | | | | | | | | | | | | | |
| | 2.7 | | | | | | | | | | | | | | | | | | | | | | | | | |
| | 3.3 | | | | | | | | | | | | | | | | | | | | | | | | | |
| | 3.9 | | | | | | | | | | | | | | | | | | | | | | | | | |
| | 4.7 | | | | | | | | | | | | | | | | | | | | | | | | | |
| | 5.6 | | | | | | | | | | | | | | | | | | | | | | | | | |
| | 6.8 | | | | | | | | | | | | | | | | | | | | | | | | | |
| | 8.2 | | | | | | | | | | | | | | | | | | | | | | | | | |
| | 10 | | | | | J | | | | | | | | | | | | | | | | | | | | |
| | 12 | | | | | J | | | | | | | | | | | | | | | | | | | | |
| | 15 | | | | | J | | | | | | | | | | | | | | | | | | | | |
| | 18 | | | | | J | | | | | | | | | | | | | | | | | | | | |
| | 22 | | | | | J | | | | | | | | | | | | | | | | | | | | |
| | 27 | | | | | J | | | | | | | | | | | | | | | | | | | | |
| | 33 | | | | | J | | | | | | | | | | | | | | | | | | | | |
| | 39 | | | | | J | | | | | | | | | | | | | | | | | | | | |
| | 47 | | | | | J | | | | | | | | | | | | | | | | | | | | |
| | 56 | | | | | J | | | | | | | | | | | | | | | | | | | | |
| | 68 | | | | | J | | | | | | | | | | | | | | | | | | | | |
| | 82 | | | | | J | | | | | | | | | | | | | | | | | | | | |
| | 100 | | | | | J | | | | | | | | | | | | | | | | | | | | |
| | 120 | | | | | J | | | | | | | | | | | | | | | | | | | | |
| | 150 | | | | | J | | | | | | | | | | | | | | | | | | | | |
| | 180 | | | | | J | | | | | | | | | | | | | | | | | | | | |
| | 220 | | | | | J | | | | | | | | | | | | | | | | | | | | |
| | 270 | | | | | J | | | | | | | | | | | | | | | | | | | | |
| | 330 | | | | | J | | | | | | | | | | | | | | | | | | | | |
| | 390 | | | | | M | | | | | | | | | | | | | | | | | | | | |
| | 470 | | | | | M | | | | | | | | | | | | | | | | | | | | |
| | 560 | J | J | J | J | M | | | | | | | | | | | | | | | | | | | | |
| | 680 | J | J | J | J | M | | | | | | | | | | | | | | | | | | | | |
| | 820 | J | J | J | J | M | | | | | | | | | | | | | | | | | | | | |
| | 1000 | J | J | J | J | M | K | K | K | K | M | M | M | M | | | | | | | M | M | P | | | |
| | 1200 | J | J | J | M | M | K | K | K | K | M | M | M | M | | | | | | | M | M | P | | | |
| | 1500 | J | J | J | M | M | K | K | K | K | M | M | M | M | | | | | | | M | M | P | | | |
| | 1800 | J | J | J | M | | K | K | K | K | M | M | M | M | | | | | | | M | M | P | | | |
| | 2200 | J | J | J | Q | | K | K | K | K | P | M | M | M | | | | | | | M | M | P | | | |
| | 2700 | J | J | J | Q | | K | K | K | P | Q | M | M | M | | | | | | | M | M | P | | | |
| | 3300 | J | J | J | | | K | K | K | P | Q | M | M | M | | | | X | | | M | M | P | | | |
| | 3900 | J | J | M | | | K | K | K | P | Q | M | M | M | | | | X | | | M | M | P | | | |
| | 4700 | J | J | M | | | K | K | K | P | Q | M | M | M | | | | X | X | X | M | M | P | | | |
| | 5600 | J | J | | | | K | K | M | P | X | M | M | M | | | | X | X | X | M | M | P | | | |
| | 6800 | J | J | | | | K | K | M | X | | M | M | M | | | | X | X | X | M | M | P | | | |
| | 8200 | J | J | | | | K | M | M | | M | M | M | | | | X | X | X | M | M | P | | | | |
| Cap (µF) | 0.010 | J | J | | | | K | M | M | | M | M | M | | | | X | X | X | M | M | P | | | | |
| | 0.012 | J | J | | | | K | M | | | M | M | M | | | | X | X | X | M | M | P | | | | |
| | 0.015 | | | | | | M | M | | | M | M | M | | | | X | X | X | M | M | P | | | | |
| | 0.018 | | | | | | M | M | | | P | M | | | | | X | X | X | M | M | Y | | | | |
| | 0.022 | | | | | | M | M | | | P | | | | | | X | X | | M | Y | Y | | | | |
| | 0.027 | | | | | | M | M | | | P | | | | | | X | X | | P | Y | Y | | | | |
| | 0.033 | | | | | | M | M | | | P | | | | | | X | X | | P | | | | | | |
| | 0.039 | | | | | | M | M | | | P | | | | | | Y | | | P | | | | | | |
| | 0.047 | | | | | | M | M | | | P | | | | | | Y | | | P | | | | | | |
| | 0.068 | | | | | | M | M | | | | | | | | | | | | P | | | | | | |
| | 0.082 | | | | | | M | M | | | | | | | | | | | | Q | | | | | | |
| | 0.1 | | | | | | | | | | | | | | | | | | | Q | | | | | | |
| WVDC | | 25 | 50 | 100 | 200 | 500 | 25 | 50 | 100 | 200 | 500 | 50 | 100 | 200 | 50 | 100 | 200 | 50 | 100 | 200 | 50 | 100 | 200 | | | |
| SIZE | | 1210 | | | | | 1812 | | | | | 1825 | | | | | 2220 | | | | | 2225 | | | | |
| Letter | | A | C | E | G | J | K | M | N | P | Q | X | Y | Z | | | | | | | | | | | | |
| Max. Thickness | | 0.33 (0.013) | 0.56 (0.022) | 0.71 (0.028) | 0.90 (0.035) | 0.94 (0.037) | 1.02 (0.040) | 1.27 (0.050) | 1.40 (0.055) | 1.52 (0.060) | 1.78 (0.070) | 2.29 (0.090) | 2.54 (0.100) | 2.79 (0.110) | | | | | | | | | | | | |
| | | PAPER | | | | | EMBOSS | | | | | | | | | | | | | | | | | | | |

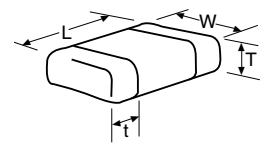

RF/Microwave COG (NP0) Capacitors (RoHS)



Ultra Low ESR, "U" Series, COG (NP0) Chip Capacitors

GENERAL INFORMATION

"U" Series capacitors are COG (NP0) chip capacitors specially designed for "Ultra" low ESR for applications in the communications market. Max ESR and effective capacitance

are met on each value producing lot to lot uniformity. Sizes available are EIA chip sizes 0603, 0805, and 1210.

DIMENSIONS: inches (millimeters)

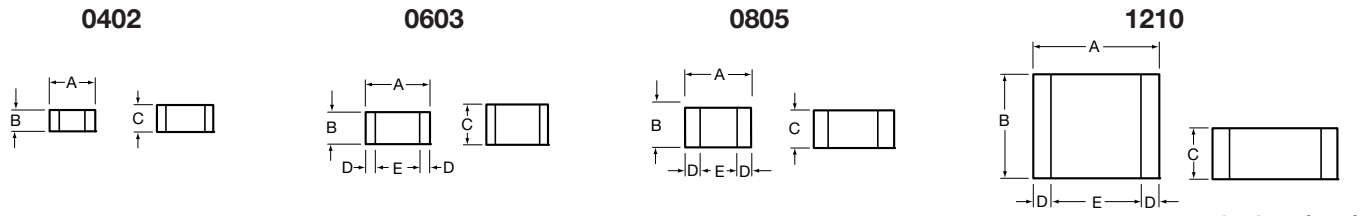

| Size | A | B | C | D | E |
|------|-------------------------|-------------------------|--------------------------|---------------------------|------------------|
| 0402 | 0.039±0.004 (1.00±0.1) | 0.020±0.004 (0.50±0.1) | 0.024 (0.6) max | N/A | N/A |
| 0603 | 0.060±0.010 (1.52±0.25) | 0.030±0.010 (0.76±0.25) | 0.036 (0.91) max | 0.010±0.005 (0.25±0.13) | 0.030 (0.76) min |
| 0805 | 0.079±0.008 (2.01±0.2) | 0.049±0.008 (1.25±0.2) | 0.040±0.005 (1.02±0.127) | 0.020±0.010 (0.51±0.255) | 0.020 (0.51) min |
| 1210 | 0.126±0.008 (3.2±0.2) | 0.098±0.008 (2.49±0.2) | 0.050±0.005 (1.27±0.127) | 0.025±0.015 (0.635±0.381) | 0.040 (1.02) min |

HOW TO ORDER

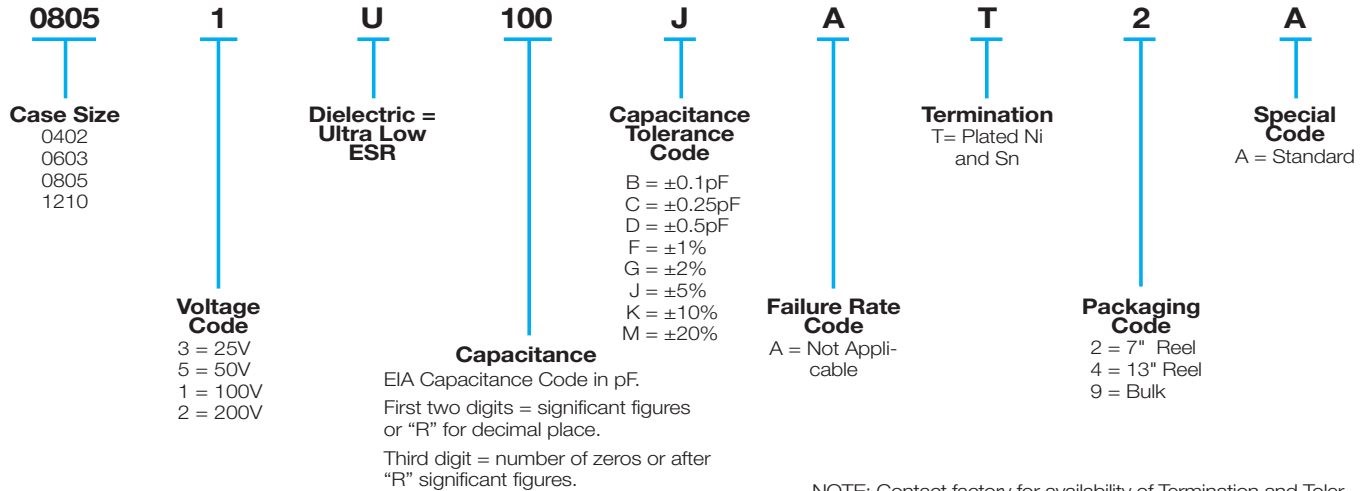

NOTE: Contact factory for availability of Termination and Tolerance Options for Specific Part Numbers.

ELECTRICAL CHARACTERISTICS

Capacitance Values and Tolerances:

- Size 0402 - 0.2 pF to 22 pF @ 1 MHz
- Size 0603 - 1.0 pF to 100 pF @ 1 MHz
- Size 0805 - 1.6 pF to 160 pF @ 1 MHz
- Size 1210 - 2.4 pF to 1000 pF @ 1 MHz

Temperature Coefficient of Capacitance (TC):

0±30 ppm/°C (-55° to +125°C)

Insulation Resistance (IR):

- 10¹² Ω min. @ 25°C and rated WVDC
- 10¹¹ Ω min. @ 125°C and rated WVDC

Working Voltage (WVDC):

- Size Working Voltage
- 0402 - 50, 25 WVDC
- 0603 - 200, 100, 50 WVDC
- 0805 - 200, 100 WVDC
- 1210 - 200, 100 WVDC

Dielectric Working Voltage (DWV):

250% of rated WVDC

Equivalent Series Resistance Typical (ESR):

- 0402 - See Performance Curve, page 9
- 0603 - See Performance Curve, page 9
- 0805 - See Performance Curve, page 9
- 1210 - See Performance Curve, page 9

Marking: Laser marking EIA J marking standard (except 0603) (capacitance code and tolerance upon request).

MILITARY SPECIFICATIONS

Meets or exceeds the requirements of MIL-C-55681



RF/Microwave C0G (NP0) Capacitors (RoHS)



Ultra Low ESR, "U" Series, C0G (NP0) Chip Capacitors

CAPACITANCE RANGE

| Cap (pF) | Available Tolerance | Size | | | |
|----------|---------------------|------|------|------|------|
| | | 0402 | 0603 | 0805 | 1210 |
| 0.2 | B,C | 50V | N/A | N/A | N/A |
| 0.3 | | | | | |
| 0.4 | B,C | | | | |
| 0.5 | B,C | | | | |
| 0.6 | B,C,D | | | | |
| 0.7 | | | | | |
| 0.8 | | | | | |
| 0.9 | B,C,D | | | | |

| Cap (pF) | Available Tolerance | Size | | | |
|----------|---------------------|------|------|------|------|
| | | 0402 | 0603 | 0805 | 1210 |
| 1.0 | B,C,D | 50V | 200V | 200V | 200V |
| 1.1 | | | | | |
| 1.2 | | | | | |
| 1.3 | | | | | |
| 1.4 | | | | | |
| 1.5 | | | | | |
| 1.6 | | | | | |
| 1.7 | | | | | |
| 1.8 | | | | | |
| 1.9 | | | | | |
| 2.0 | | | | | |
| 2.1 | | | | | |
| 2.2 | | | | | |
| 2.4 | | | | | |
| 2.7 | | | | | |
| 3.0 | | | | | |
| 3.3 | | | | | |
| 3.6 | | | | | |
| 3.9 | | | | | |
| 4.3 | | | | | |
| 4.7 | | | | | |
| 5.1 | | | | | |
| 5.6 | | | | | |
| 6.2 | B,C,D | | | | |
| 6.8 | B,C,J,K,M | | | | |

| Cap (pF) | Available Tolerance | Size | | | |
|----------|---------------------|------|------|------|------|
| | | 0402 | 0603 | 0805 | 1210 |
| 7.5 | B,C,J,K,M | 50V | 200V | 200V | 200V |
| 8.2 | | | | | |
| 9.1 | B,C,J,K,M | | | | |
| 10 | F,G,J,K,M | | | | |
| 11 | | | | | |
| 12 | | | | | |
| 13 | | | | | |
| 15 | | | | | |
| 18 | | | | | |
| 20 | | | | | |
| 22 | | | | | |
| 24 | | | | | |
| 27 | | | | | |
| 30 | | | | | |
| 33 | | | | | |
| 36 | | | | | |
| 39 | | | | | |
| 43 | | | | | |
| 47 | | | | | |
| 51 | | | | | |
| 56 | | | | | |
| 68 | | | | | |
| 75 | | | | | |
| 82 | | | | | |
| 91 | | | | | |

| Cap (pF) | Available Tolerance | Size | | | |
|----------|---------------------|------|------|------|------|
| | | 0402 | 0603 | 0805 | 1210 |
| 100 | F,G,J,K,M | N/A | 100V | 200V | 200V |
| 110 | | | 50V | | |
| 120 | | | 50V | | |
| 130 | | | N/A | | |
| 140 | | | | 200V | |
| 150 | | | | 100V | |
| 160 | | | | | |
| 180 | | | | 100V | |
| 200 | | | | N/A | |
| 220 | | | | | |
| 270 | | | | | |
| 300 | | | | | |
| 330 | | | | | |
| 360 | | | | | |
| 390 | | | | | |
| 430 | | | | | |
| 470 | | | | | |
| 510 | | | | | |
| 560 | | | | | |
| 620 | | | | | |
| 680 | | | | | |
| 750 | | | | | |
| 820 | | | | | |
| 910 | | | | | |
| 1000 | F,G,J,K,M | | | | |

ULTRA LOW ESR, "U" SERIES

TYPICAL ESR vs. FREQUENCY
0402 "U" SERIES

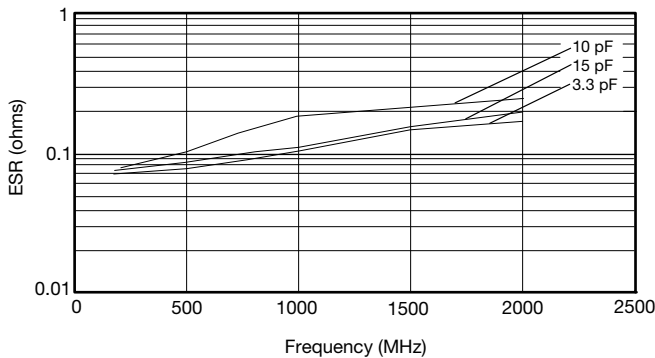

TYPICAL ESR vs. FREQUENCY
0603 "U" SERIES

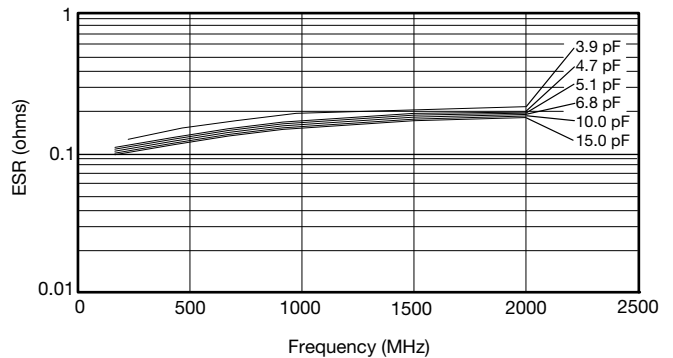

TYPICAL ESR vs. FREQUENCY
0805 "U" SERIES

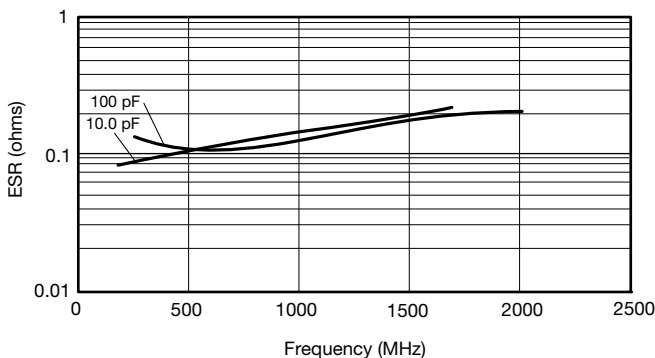

TYPICAL ESR vs. FREQUENCY
1210 "U" SERIES

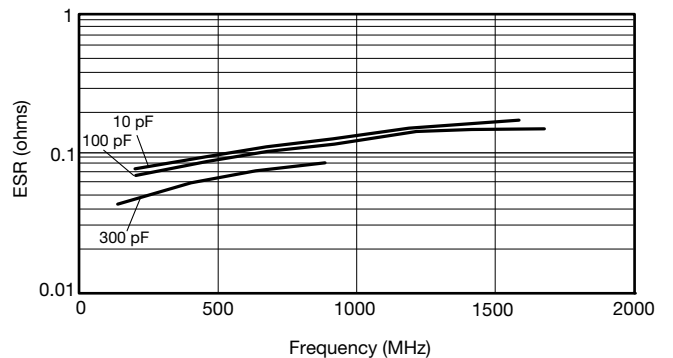

ESR Measured on the Boonton 34A



RF/Microwave C0G (NP0) Capacitors



Ultra Low ESR, "U" Series, C0G (NP0) Chip Capacitors

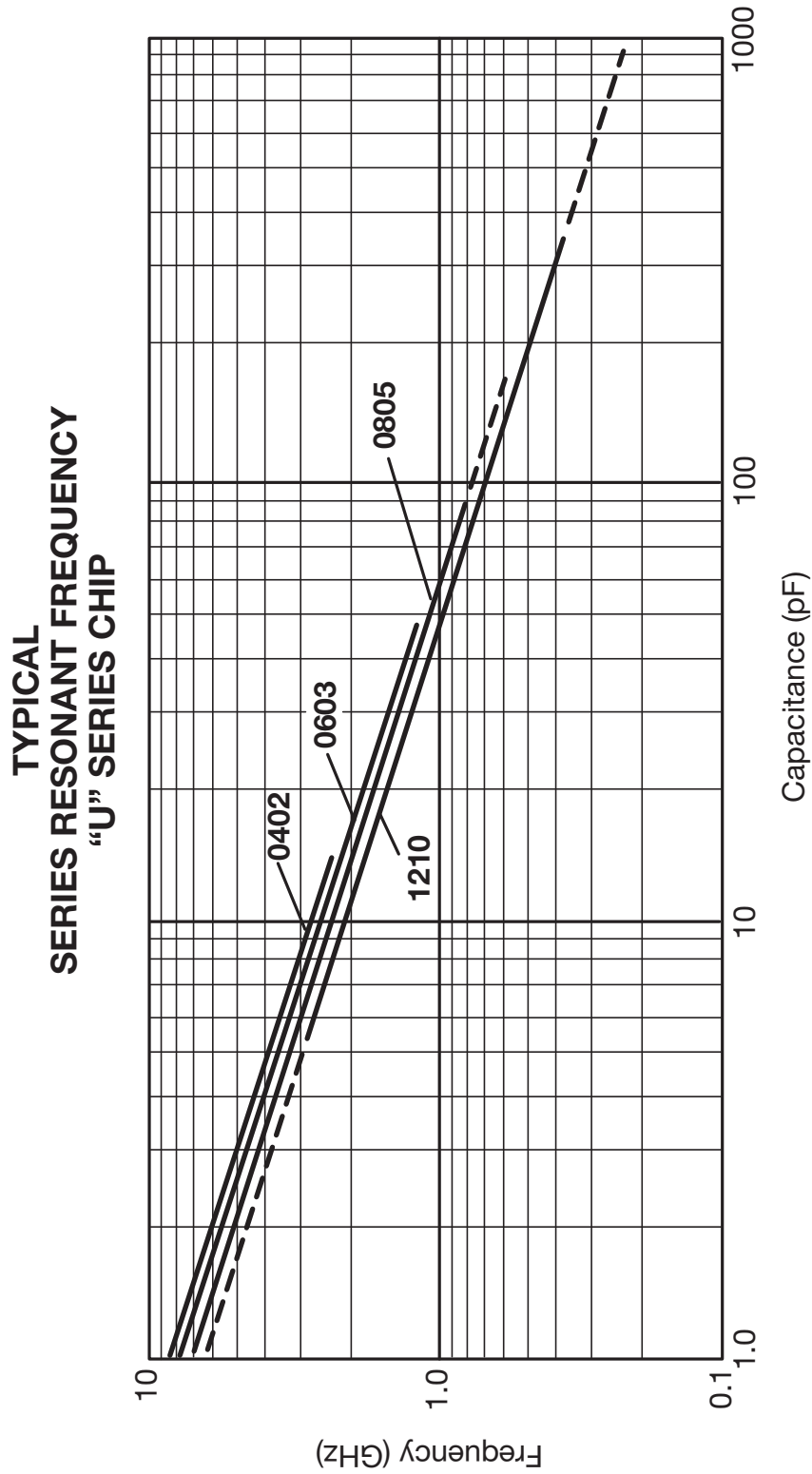

RF/Microwave C0G (NP0) Capacitors (Sn/Pb)

Ultra Low ESR, "U" Series, C0G (NP0) Chip Capacitors

GENERAL INFORMATION

"U" Series capacitors are C0G (NP0) chip capacitors specially designed for "Ultra" low ESR for applications in the communications market. Max ESR and effective capacitance

are met on each value producing lot to lot uniformity. Sizes available are EIA chip sizes 0603, 0805, and 1210.

DIMENSIONS: inches (millimeters)

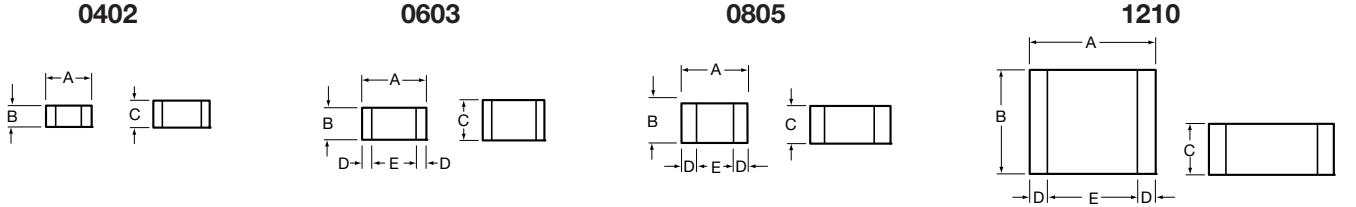

| Size | A | B | C | D | E |
|------|-------------------------|-------------------------|--------------------------|---------------------------|------------------|
| 0402 | 0.039±0.004 (1.00±0.1) | 0.020±0.004 (0.50±0.1) | 0.024 (0.6) max | N/A | N/A |
| 0603 | 0.060±0.010 (1.52±0.25) | 0.030±0.010 (0.76±0.25) | 0.036 (0.91) max | 0.010±0.005 (0.25±0.13) | 0.030 (0.76) min |
| 0805 | 0.079±0.008 (2.01±0.2) | 0.049±0.008 (1.25±0.2) | 0.040±0.005 (1.02±0.127) | 0.020±0.010 (0.51±0.254) | 0.020 (0.51) min |
| 1210 | 0.126±0.008 (3.2±0.2) | 0.098±0.008 (2.49±0.2) | 0.050±0.005 (1.27±0.127) | 0.025±0.015 (0.635±0.381) | 0.040 (1.02) min |

HOW TO ORDER

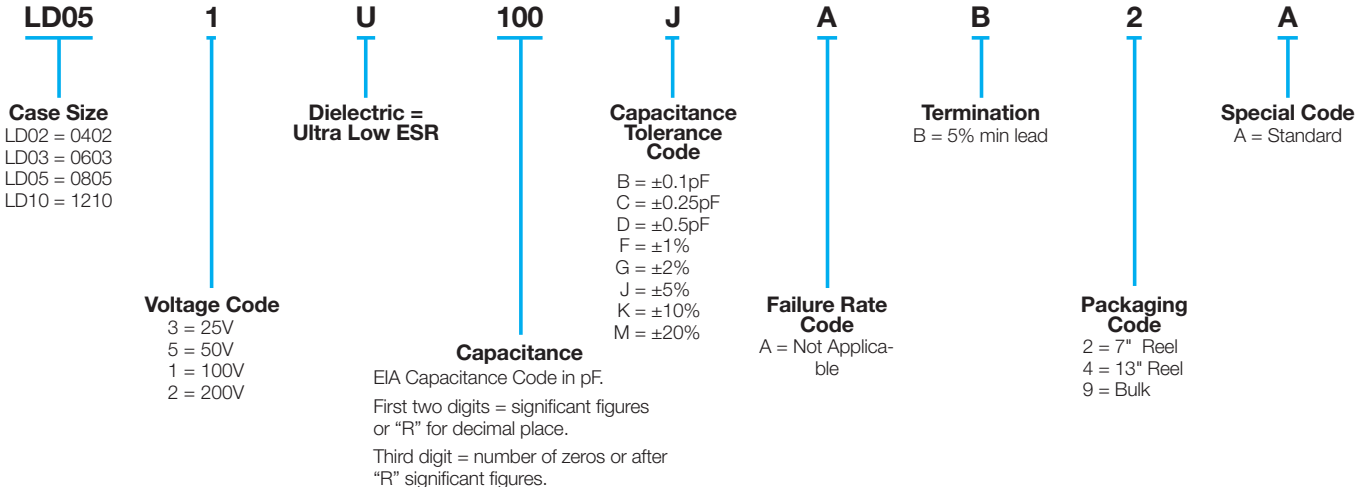

ELECTRICAL CHARACTERISTICS

Capacitance Values and Tolerances:

- Size 0402 - 0.2 pF to 22 pF @ 1 MHz
- Size 0603 - 1.0 pF to 100 pF @ 1 MHz
- Size 0805 - 1.6 pF to 160 pF @ 1 MHz
- Size 1210 - 2.4 pF to 1000 pF @ 1 MHz

Temperature Coefficient of Capacitance (TC):

0±30 ppm/°C (-55° to +125°C)

Insulation Resistance (IR):

- 10¹² Ω min. @ 25°C and rated WVDC
- 10¹¹ Ω min. @ 125°C and rated WVDC

Working Voltage (WVDC):

- Size Working Voltage
- 0402 - 50, 25 WVDC
- 0603 - 200, 100, 50 WVDC
- 0805 - 200, 100 WVDC
- 1210 - 200, 100 WVDC

Dielectric Working Voltage (DWW):

250% of rated WVDC

Equivalent Series Resistance Typical (ESR):

- 0402 - See Performance Curve, page 12
- 0603 - See Performance Curve, page 12
- 0805 - See Performance Curve, page 12
- 1210 - See Performance Curve, page 12

Marking: Laser marking EIA J marking standard (except 0603) (capacitance code and tolerance upon request).

MILITARY SPECIFICATIONS

Meets or exceeds the requirements of MIL-C-55681

RF/Microwave C0G (NP0) Capacitors (Sn/Pb)



Ultra Low ESR, "U" Series, C0G (NP0) Chip Capacitors

CAPACITANCE RANGE

| Cap (pF) | Available Tolerance | Size | | | | Cap (pF) | Available Tolerance | Size | | | | Cap (pF) | Available Tolerance | Size | | | | Cap (pF) | Available Tolerance | Size | | | |
|----------|---------------------|------|------|------|------|----------|---------------------|------|------|------|------|----------|---------------------|------|------|------|------|----------|---------------------|------|------|------|------|
| | | LD02 | LD03 | LD05 | LD10 | | | LD02 | LD03 | LD05 | LD10 | | | LD02 | LD03 | LD05 | LD10 | | | LD02 | LD03 | LD05 | LD10 |
| 0.2 | B,C | 50V | N/A | N/A | N/A | 1.0 | B,C,D | 50V | 200V | 200V | 200V | 100 | F,G,J,K,M | N/A | 100V | 200V | 200V | 110 | | N/A | 100V | 200V | 200V |
| 0.3 | | | | | | 1.1 | | | | | | 110 | | | | | | 120 | | | 50V | 200V | 200V |
| 0.4 | | | | | | 1.2 | | | | | | 120 | | | | | | 130 | | | 50V | 200V | 200V |
| 0.5 | B,C | | | | | 1.3 | | | | | | 130 | | | | | | 140 | | | N/A | 200V | 200V |
| 0.6 | B,C,D | | | | | 1.4 | | | | | | 140 | | | | | | 150 | | | | 100V | 200V |
| 0.7 | | | | | | 1.5 | | | | | | 150 | | | | | | 160 | | | | 100V | 200V |
| 0.8 | | | | | | 1.6 | | | | | | 160 | | | | | | 180 | | | | 100V | 200V |
| 0.9 | B,C,D | | | | | 1.7 | | | | | | 180 | | | | | | 200 | | | | 100V | 200V |
| | | | | | | 1.8 | | | | | | 200 | | | | | | 220 | | | | 100V | 200V |
| | | | | | | 1.9 | | | | | | 220 | | | | | | 270 | | | | 100V | 200V |
| | | | | | | 2.0 | | | | | | 270 | | | | | | 300 | | | | 100V | 200V |
| | | | | | | 2.1 | | | | | | 300 | | | | | | 330 | | | | 100V | 200V |
| | | | | | | 2.2 | | | | | | 330 | | | | | | 360 | | | | 100V | 200V |
| | | | | | | 2.4 | | | | | | 360 | | | | | | 390 | | | | 100V | 200V |
| | | | | | | 2.7 | | | | | | 390 | | | | | | 430 | | | | 100V | 200V |
| | | | | | | 3.0 | | | | | | 430 | | | | | | 470 | | | | 100V | 200V |
| | | | | | | 3.3 | | | | | | 470 | | | | | | 510 | | | | 100V | 200V |
| | | | | | | 3.6 | | | | | | 510 | | | | | | 560 | | | | 100V | 200V |
| | | | | | | 3.9 | | | | | | 560 | | | | | | 620 | | | | 100V | 200V |
| | | | | | | 4.3 | | | | | | 620 | | | | | | 680 | | | | 100V | 200V |
| | | | | | | 4.7 | | | | | | 680 | | | | | | 750 | | | | 100V | 200V |
| | | | | | | 5.1 | | | | | | 750 | | | | | | 820 | | | | 100V | 200V |
| | | | | | | 5.6 | | | | | | 820 | | | | | | 910 | | | | 100V | 200V |
| | | | | | | 6.2 | B,C,D | | | | | 910 | | | | | | 1000 | | | | 100V | 200V |
| | | | | | | 6.8 | B,C,J,K,M | | | | | 1000 | F,G,J,K,M | | | | | | | | | | |

ULTRA LOW ESR, "U" SERIES

TYPICAL ESR vs. FREQUENCY
0402 "U" SERIES

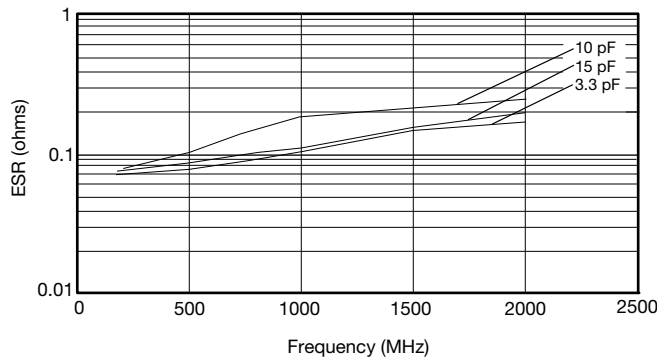

TYPICAL ESR vs. FREQUENCY
0603 "U" SERIES

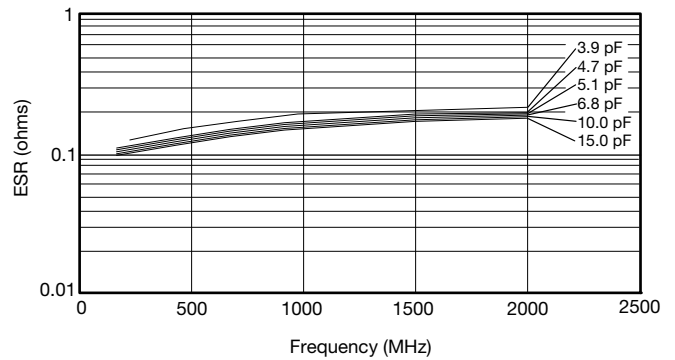

TYPICAL ESR vs. FREQUENCY
0805 "U" SERIES

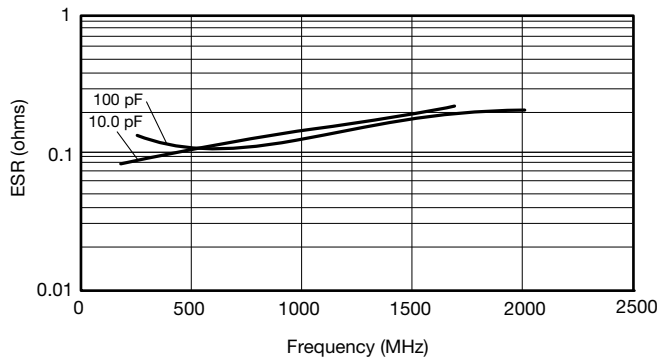

TYPICAL ESR vs. FREQUENCY
1210 "U" SERIES

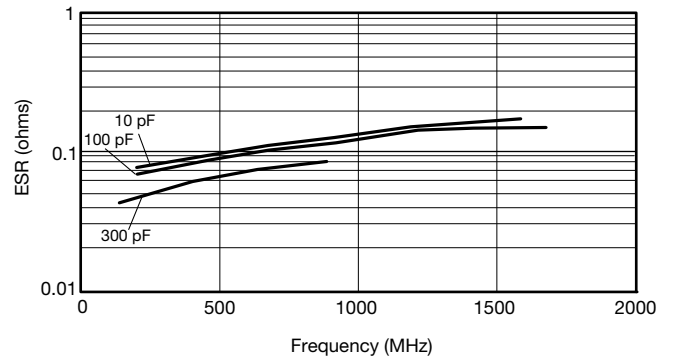

ESR Measured on the Boonton 34A

“U” SERIES KITS

0402

| Kit 5000 UZ | | | |
|---------------|--------------------------|---------------|--------------------------|
| Cap. Value pF | Tolerance | Cap. Value pF | Tolerance |
| 0.5 | B ($\pm 0.1\text{pF}$) | 4.7 | B ($\pm 0.1\text{pF}$) |
| 1.0 | | 5.6 | |
| 1.5 | | 6.8 | |
| 1.8 | | 8.2 | |
| 2.2 | | 10.0 | |
| 2.4 | J ($\pm 5\%$) | 12.0 | J ($\pm 5\%$) |
| 3.0 | | 15.0 | |
| 3.6 | | | |
| | | | |

***25 each of 15 values

0603

| Kit 4000 UZ | | | |
|---------------|--------------------------|---------------|--------------------------|
| Cap. Value pF | Tolerance | Cap. Value pF | Tolerance |
| 1.0 | B ($\pm 0.1\text{pF}$) | 6.8 | B ($\pm 0.1\text{pF}$) |
| 1.2 | | 7.5 | |
| 1.5 | | 8.2 | |
| 1.8 | | 10.0 | J ($\pm 5\%$) |
| 2.0 | | 12.0 | |
| 2.4 | | 15.0 | |
| 2.7 | | 18.0 | |
| 3.0 | | 22.0 | |
| 3.3 | | 27.0 | |
| 3.9 | | 33.0 | |
| 4.7 | 39.0 | | |
| 5.6 | 47.0 | | |

***25 each of 24 values

0805

| Kit 3000 UZ | | | | | |
|---------------|--------------------------|-----------------|-----------------|-------|-----------------|
| Cap. Value pF | Tolerance | Cap. Value pF | Tolerance | | |
| 1.0 | B ($\pm 0.1\text{pF}$) | 15.0 | J ($\pm 5\%$) | | |
| 1.5 | | 18.0 | | | |
| 2.2 | | 22.0 | | | |
| 2.4 | | 24.0 | | | |
| 2.7 | | 27.0 | | | |
| 3.0 | | 33.0 | | | |
| 3.3 | | 36.0 | | | |
| 3.9 | | 39.0 | | | |
| 4.7 | | 47.0 | | | |
| 5.6 | | 56.0 | | | |
| 7.5 | | 68.0 | | | |
| 8.2 | | 82.0 | | | |
| 9.1 | | 100.0 | | | |
| 10.0 | | J ($\pm 5\%$) | | 130.0 | J ($\pm 5\%$) |
| 12.0 | | | | 160.0 | |

***25 each of 30 values

1210

| Kit 3500 UZ | | | | |
|---------------|--------------------------|-----------------|-----------------|-------|
| Cap. Value pF | Tolerance | Cap. Value pF | Tolerance | |
| 2.2 | B ($\pm 0.1\text{pF}$) | 36.0 | J ($\pm 5\%$) | |
| 2.7 | | 39.0 | | |
| 4.7 | | 47.0 | | |
| 5.1 | | 51.0 | | |
| 6.8 | | 56.0 | | |
| 8.2 | | 68.0 | | |
| 9.1 | | 82.0 | | |
| 10.0 | | J ($\pm 5\%$) | | 100.0 |
| 13.0 | 120.0 | | | |
| 15.0 | 130.0 | | | |
| 18.0 | 240.0 | | | |
| 20.0 | 300.0 | | | |
| 24.0 | 390.0 | | | |
| 27.0 | 470.0 | | | |
| 30.0 | 680.0 | | | |

***25 each of 30 values

X8R Dielectric



General Specifications

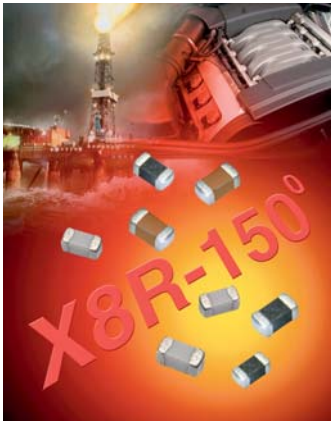

AVX have developed a range of multilayer ceramic capacitors designed for use in applications up to 150°C. These capacitors are manufactured with an X8R dielectric material which has a capacitance variation of ±15% between -55°C and +150°C.

The need for X8R performance has been driven by customer requirements for parts that operate at elevated temperatures. They provide a highly reliable capacitor with low loss and stable capacitance over temperature.

They are ideal for automotive under the hood sensors, measure while drilling and log while drilling. Typical applications include wire line logging tools such as gamma ray receivers, acoustic transceivers and micro-resistivity tools. They can also be used as bulk capacitors for high temperature camera modules.

X8R capacitors are available as standard and Automotive AEC-Q200 qualified parts. Optional termination systems, tin, FLEXITERM® and conductive epoxy for hybrid applications are available. Providing this series with our FLEXITERM® termination system provides further advantage to customers by way of enhanced resistance to both, temperature cycling and mechanical damage.

PART NUMBER (see page 2 for complete part number explanation)

| | | | | | | | | |
|-------------------------------------|--------------------------------------|------------------------------|---|---|---|---|---|---|
| 0805 | 5 | F | 104 | K | 4 | T | 2 | A |
| Size 0603 0805 1206 | Voltage 25V = 3 50V = 5 | Dielectric X8R = F | Capacitance Code (In pF) 2 Sig. Digits + Number of Zeros e.g. 10µF = 106 | Capacitance Tolerance J = ± 5% K = ±10% M = ± 20% | Failure Rate 4 = Automotive A = Not Applicable | Terminations T = Plated Ni and Sn Z = FLEXITERM® U = Conductive Epoxy for Hybrid apps | Packaging 2 = 7" Reel 4 = 13" Reel | Special Code A = Std. Product |

NOTE: Contact factory for availability of Termination and Tolerance Options for Specific Part Numbers.

| SIZE | | 0603 | | 0805 | | 1206 | |
|------|------------|-------------|-----|-------------|-----|-------------|-----|
| | WVDC | 25V | 50V | 25V | 50V | 25V | 50V |
| 271 | Cap 270 | G | G | | | | |
| 331 | (pF) 330 | G | G | J | J | | |
| 471 | 470 | G | G | J | J | | |
| 681 | 680 | G | G | J | J | | |
| 102 | 1000 | G | G | J | J | J | J |
| 152 | 1500 | G | G | J | J | J | J |
| 182 | 1800 | G | G | J | J | J | J |
| 222 | 2200 | G | G | J | J | J | J |
| 272 | 2700 | G | G | J | J | J | J |
| 332 | 3300 | G | G | J | J | J | J |
| 392 | 3900 | G | G | J | J | J | J |
| 472 | 4700 | G | G | J | J | J | J |
| 562 | 5600 | G | G | J | J | J | J |
| 682 | 6800 | G | G | J | J | J | J |
| 822 | 8200 | G | G | J | J | J | J |
| 103 | Cap 0.01 | G | G | J | J | J | J |
| 123 | (µF) 0.012 | G | G | J | J | J | J |
| 153 | 0.015 | G | G | J | J | J | J |
| 183 | 0.018 | G | G | J | J | J | J |
| 223 | 0.022 | G | G | J | J | J | J |
| 273 | 0.027 | G | G | J | J | J | J |
| 333 | 0.033 | G | G | J | J | J | J |
| 393 | 0.039 | G | G | J | J | J | J |
| 473 | 0.047 | G | G | J | J | J | J |
| 563 | 0.056 | G | | N | N | M | M |
| 683 | 0.068 | G | | N | N | M | M |
| 823 | 0.082 | | | N | N | M | M |
| 104 | 0.1 | | | N | N | M | M |
| 124 | 0.12 | | | N | N | M | M |
| 154 | 0.15 | | | N | N | M | M |
| 184 | 0.18 | | | N | | M | M |
| 224 | 0.22 | | | N | | M | M |
| 274 | 0.27 | | | | | M | M |
| 334 | 0.33 | | | | | M | M |
| 394 | 0.39 | | | | | M | |
| 474 | 0.47 | | | | | M | |
| 684 | 0.68 | | | | | | |
| 824 | 0.82 | | | | | | |
| 105 | 1 | | | | | | |
| SIZE | WVDC | 25V | 50V | 25V | 50V | 25V | 50V |
| | | 0603 | | 0805 | | 1206 | |

| Letter | A | C | E | G | J | K | M | N | P | Q | X | Y | Z |
|----------------|-----------------|-----------------|-----------------|-----------------|-----------------|-----------------|-----------------|-----------------|-----------------|-----------------|-----------------|-----------------|-----------------|
| Max. Thickness | 0.33 (0.013) | 0.56 (0.022) | 0.71 (0.028) | 0.90 (0.035) | 0.94 (0.037) | 1.02 (0.040) | 1.27 (0.050) | 1.40 (0.055) | 1.52 (0.060) | 1.78 (0.070) | 2.29 (0.090) | 2.54 (0.100) | 2.79 (0.110) |
| | PAPER | | | | | EMBOSSED | | | | | | | |



= AEC-Q200 Qualified

X8R Dielectric

General Specifications



APPLICATIONS FOR X8R CAPACITORS

- All market sectors with a 150°C requirement
- Automotive on engine applications
- Oil exploration applications
- Hybrid automotive applications
 - Battery control
 - Inverter / converter circuits
 - Motor control applications
 - Water pump
- Hybrid commercial applications
 - Emergency circuits
 - Sensors
 - Temperature regulation

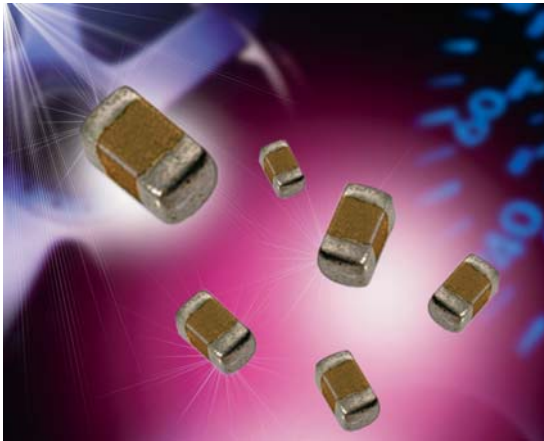
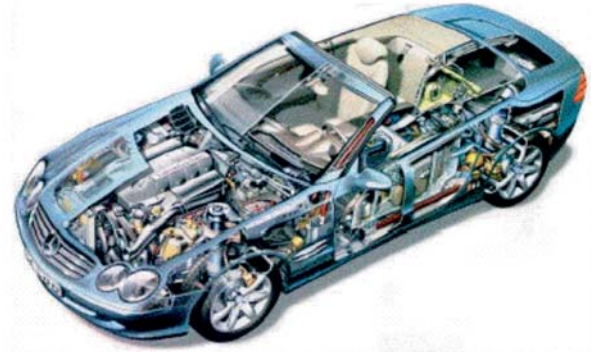

ADVANTAGES OF X8R MLC CAPACITORS

- Capacitance variation of $\pm 15\%$ between -55°C and $+150^{\circ}\text{C}$
- Qualified to the highest automotive AEC-Q200 standards
- Excellent reliability compared to other capacitor technologies
- RoHS compliant
- Low ESR / ESL compared to other technologies
- Tin solder finish
- FLEXITERM® available
- Hybrid available
- 50V range available

ENGINEERING TOOLS FOR HIGH VOLTAGE MLC CAPACITORS

- Samples
- Technical Articles
- Application Engineering
- Application Support

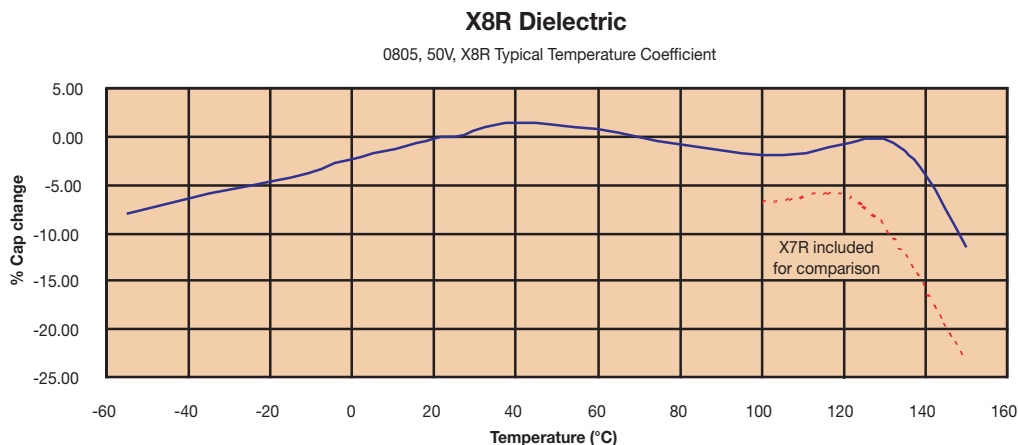

X7R Dielectric

General Specifications

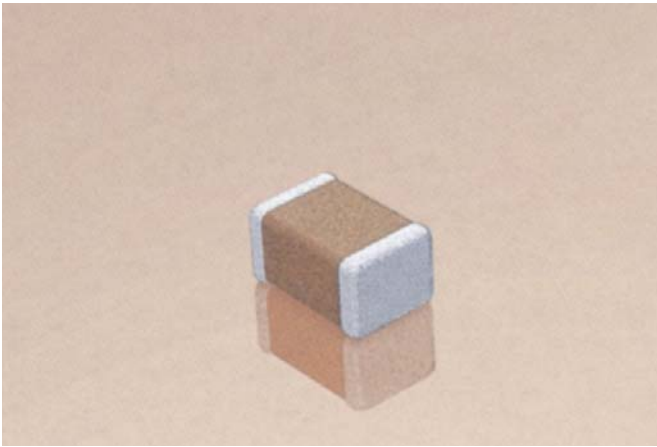

X7R formulations are called "temperature stable" ceramics and fall into EIA Class II materials. X7R is the most popular of these intermediate dielectric constant materials. Its temperature variation of capacitance is within $\pm 15\%$ from -55°C to $+125^{\circ}\text{C}$. This capacitance change is non-linear.

Capacitance for X7R varies under the influence of electrical operating conditions such as voltage and frequency.

X7R dielectric chip usage covers the broad spectrum of industrial applications where known changes in capacitance due to applied voltages are acceptable.

PART NUMBER (see page 2 for complete part number explanation)

| | | | | | | | | |
|--------------------------|--|------------------------------|---|---|---|---|---|---|
| 0805 | 5 | C | 103 | M | A | T | 2 | A |
| Size (L" x W") | Voltage 4V = 4 6.3V = 6 10V = Z 16V = Y 25V = 3 50V = 5 100V = 1 200V = 2 500V = 7 | Dielectric X7R = C | Capacitance Code (In pF) 2 Sig. Digits + Number of Zeros | Capacitance Tolerance J = $\pm 5\%$ * K = $\pm 10\%$ M = $\pm 20\%$ * $\leq 1\mu\text{F}$ only | Failure Rate A = Not Applicable | Terminations T = Plated Ni and Sn 7 = Gold Plated* Z = FLEXITERM®** | Packaging 2 = 7" Reel 4 = 13" Reel 7 = Bulk Cass. 9 = Bulk | Special Code A = Std. Product |
| | | | | | | *Optional termination | Contact Factory For Multiples | |
| | | | | | | **See FLEXITERM® X7R section | | |

NOTE: Contact factory for availability of Termination and Tolerance Options for Specific Part Numbers. Contact factory for non-specified capacitance values.

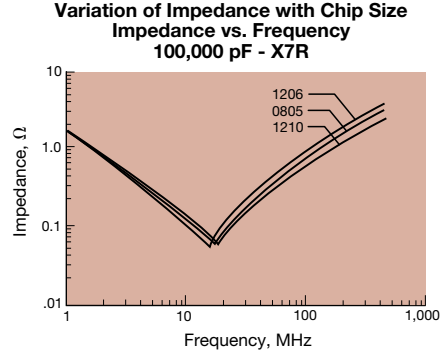
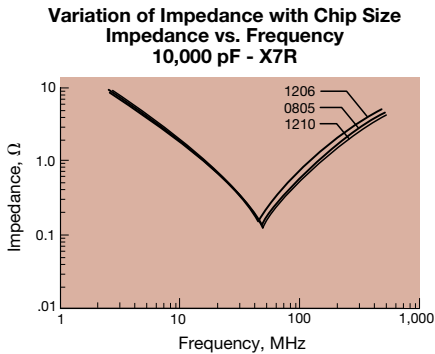
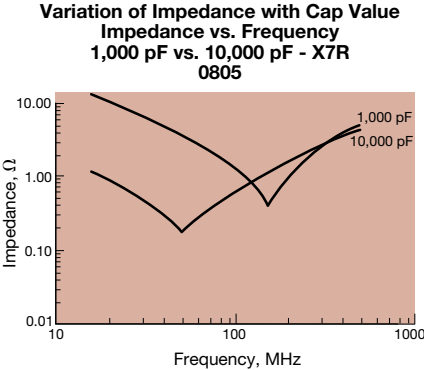
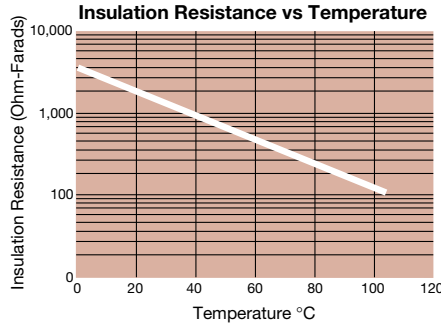
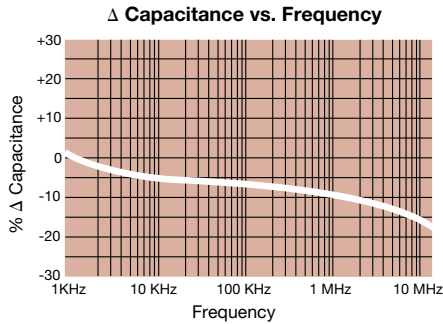
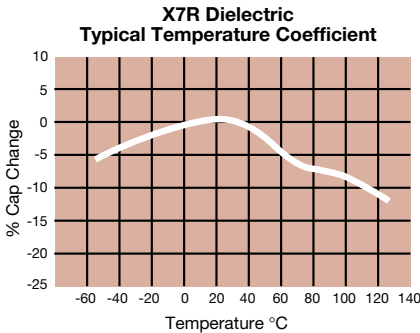

X7R Dielectric

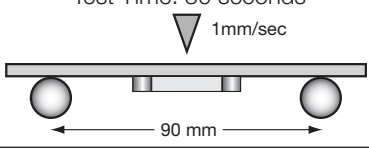

Specifications and Test Methods

| Parameter/Test | | X7R Specification Limits | Measuring Conditions | |
|--------------------------------|-----------------------|--|---|----------------|
| Operating Temperature Range | | -55°C to +125°C | Temperature Cycle Chamber | |
| Capacitance | | Within specified tolerance | Freq.: 1.0 kHz ± 10% Voltage: 1.0Vrms ± .2V For Cap > 10 µF, 0.5Vrms @ 120Hz | |
| Dissipation Factor | | ≤ 2.5% for ≥ 50V DC rating ≤ 3.0% for 25V DC rating ≤ 3.5% for 16V DC rating ≤ 5.0% for ≤ 10V DC rating | | |
| Insulation Resistance | | 100,000MΩ or 1000MΩ - µF, whichever is less | Charge device with rated voltage for 120 ± 5 secs @ room temp/humidity | |
| Dielectric Strength | | No breakdown or visual defects | Charge device with 300% of rated voltage for 1-5 seconds, w/charge and discharge current limited to 50 mA (max) Note: Charge device with 150% of rated voltage for 500V devices. | |
| Resistance to Flexure Stresses | Appearance | No defects | Deflection: 2mm Test Time: 30 seconds  | |
| | Capacitance Variation | ≤ ±12% | | |
| | Dissipation Factor | Meets Initial Values (As Above) | | |
| | Insulation Resistance | ≥ Initial Value x 0.3 | | |
| Solderability | | ≥ 95% of each terminal should be covered with fresh solder | Dip device in eutectic solder at 230 ± 5°C for 5.0 ± 0.5 seconds | |
| Resistance to Solder Heat | Appearance | No defects, <25% leaching of either end terminal | Dip device in eutectic solder at 260°C for 60 seconds. Store at room temperature for 24 ± 2 hours before measuring electrical properties. | |
| | Capacitance Variation | ≤ ±7.5% | | |
| | Dissipation Factor | Meets Initial Values (As Above) | | |
| | Insulation Resistance | Meets Initial Values (As Above) | | |
| | Dielectric Strength | Meets Initial Values (As Above) | | |
| Thermal Shock | Appearance | No visual defects | Step 1: -55°C ± 2° | 30 ± 3 minutes |
| | Capacitance Variation | ≤ ±7.5% | Step 2: Room Temp | ≤ 3 minutes |
| | Dissipation Factor | Meets Initial Values (As Above) | Step 3: +125°C ± 2° | 30 ± 3 minutes |
| | Insulation Resistance | Meets Initial Values (As Above) | Step 4: Room Temp | ≤ 3 minutes |
| | Dielectric Strength | Meets Initial Values (As Above) | Repeat for 5 cycles and measure after 24 ± 2 hours at room temperature | |
| Load Life | Appearance | No visual defects | Charge device with 1.5 rated voltage (≤ 10V) in test chamber set at 125°C ± 2°C for 1000 hours (+48, -0) Remove from test chamber and stabilize at room temperature for 24 ± 2 hours before measuring. | |
| | Capacitance Variation | ≤ ±12.5% | | |
| | Dissipation Factor | ≤ Initial Value x 2.0 (See Above) | | |
| | Insulation Resistance | ≥ Initial Value x 0.3 (See Above) | | |
| | Dielectric Strength | Meets Initial Values (As Above) | | |
| Load Humidity | Appearance | No visual defects | Store in a test chamber set at 85°C ± 2°C/ 85% ± 5% relative humidity for 1000 hours (+48, -0) with rated voltage applied. Remove from chamber and stabilize at room temperature and humidity for 24 ± 2 hours before measuring. | |
| | Capacitance Variation | ≤ ±12.5% | | |
| | Dissipation Factor | ≤ Initial Value x 2.0 (See Above) | | |
| | Insulation Resistance | ≥ Initial Value x 0.3 (See Above) | | |
| | Dielectric Strength | Meets Initial Values (As Above) | | |

X7R Dielectric



Capacitance Range

PREFERRED SIZES ARE SHADED

| SIZE | 0201 | | | 0402 | | | 0603 | | | | | | 0805 | | | | | | 1206 | | | | | | | | | | | | | | | | |
|-------------------|--------------------------------|----|----|--------------------------------|----|----|--------------------------------|----|----|----|----|-----|--------------------------------|-----|----|----|----|----|--------------------------------|-----|-----|----|----|----|----|-----|-----|-----|----|----|----|----|-----|-----|-----|
| | Reflow Only | | | Reflow/Wave | | | Reflow/Wave | | | | | | Reflow/Wave | | | | | | Reflow/Wave | | | | | | | | | | | | | | | | |
| Packaging | All Paper | | | All Paper | | | All Paper | | | | | | Paper/Embossed | | | | | | Paper/Embossed | | | | | | | | | | | | | | | | |
| (L) Length (mm) | 0.60 ± 0.03 (0.024 ± 0.001) | | | 1.00 ± 0.10 (0.040 ± 0.004) | | | 1.60 ± 0.15 (0.063 ± 0.006) | | | | | | 2.01 ± 0.20 (0.079 ± 0.008) | | | | | | 3.20 ± 0.20 (0.126 ± 0.008) | | | | | | | | | | | | | | | | |
| (W) Width (mm) | 0.30 ± 0.03 (0.011 ± 0.001) | | | 0.50 ± 0.10 (0.020 ± 0.004) | | | 0.81 ± 0.15 (0.032 ± 0.006) | | | | | | 1.25 ± 0.20 (0.049 ± 0.008) | | | | | | 1.60 ± 0.20 (0.063 ± 0.008) | | | | | | | | | | | | | | | | |
| (t) Terminal (mm) | 0.15 ± 0.05 (0.006 ± 0.002) | | | 0.25 ± 0.15 (0.010 ± 0.006) | | | 0.35 ± 0.15 (0.014 ± 0.006) | | | | | | 0.50 ± 0.25 (0.020 ± 0.010) | | | | | | 0.50 ± 0.25 (0.020 ± 0.010) | | | | | | | | | | | | | | | | |
| WVDC | 10 | 16 | 25 | 16 | 25 | 50 | 6.3 | 10 | 16 | 25 | 50 | 100 | 200 | 6.3 | 10 | 16 | 25 | 50 | 100 | 200 | 6.3 | 10 | 16 | 25 | 50 | 100 | 200 | 6.3 | 10 | 16 | 25 | 50 | 100 | 200 | 500 |
| Cap (pF) | 100 | A | A | A | | | | | | | | | | | | | | | | | | | | | | | | | | | | | | | |
| | 150 | A | A | A | | | | | | | | | | | | | | | | | | | | | | | | | | | | | | | |
| | 220 | A | A | A | | | C | | | | | | | | | | | | | | | | | | | | | | | | | | | | |
| | 330 | A | A | A | | | C | | | | G | G | G | | J | J | J | J | J | J | J | | | | | | | | | | | | K | | |
| | 470 | A | A | A | | | C | | | | G | G | G | | J | J | J | J | J | J | J | | | | | | | | | | | | K | | |
| | 680 | A | A | A | | | C | | | | G | G | G | | J | J | J | J | J | J | J | | | | | | | | | | | | K | | |
| | 1000 | A | A | | | | C | | | | G | G | G | | J | J | J | J | J | J | J | | | | | | | | | | | | M | | |
| | 1500 | A | A | | | | C | | | | G | G | G | | J | J | J | J | J | J | J | | | | | J | J | J | J | J | J | J | M | | |
| | 2200 | A | A | | | | C | | | | G | G | G | | J | J | J | J | J | J | J | | | | | J | J | J | J | J | J | J | M | | |
| | 3300 | A | A | | | | C | C | | | G | G | G | | J | J | J | J | J | J | J | | | | | J | J | J | J | J | J | J | M | | |
| | 4700 | A | A | | | | C | C | | | G | G | G | | J | J | J | J | J | J | J | | | | | J | J | J | J | J | J | J | M | | |
| | 6800 | A | A | | | | C | C | | | G | G | G | | J | J | J | J | J | J | J | | | | | J | J | J | J | J | J | J | P | | |
| Cap (µF) | 0.010 | A | | | | | C | C | | | | | | | J | J | J | J | J | J | J | | | | | J | J | J | J | J | J | J | P | | |
| | 0.015 | | | | | | C | C | | | G | G | G | | J | J | J | J | J | J | J | | | | | J | J | J | J | J | J | J | M | | |
| | 0.022 | | | | | | C | C | | | G | G | G | | J | J | J | J | J | J | J | | | | | J | J | J | J | J | J | J | M | | |
| | 0.033 | | | | | | | | | | G | G | G | | J | J | J | J | J | N | | | | | | J | J | J | J | J | J | J | M | | |
| | 0.047 | | | | | | | | | | G | G | G | | J | J | J | J | J | N | | | | | | J | J | J | J | J | J | J | M | | |
| | 0.068 | | | | | | | | | | G | G | G | | J | J | J | J | J | N | | | | | | J | J | J | J | J | J | J | P | | |
| | 0.10 | | | | | | C | | | | G | G | G | | J | J | J | J | J | N | | | | | J | J | J | J | J | J | J | P | | | |
| | 0.15 | | | | | | | | | | G | G | G | | J | J | J | J | J | N | | | | | J | J | J | J | J | J | J | | | | |
| | 0.22 | | | | | | | | | | G | G | G | | J | J | J | J | J | N | | | | | J | J | J | J | J | J | J | Q | | | |
| | 0.33 | | | | | | | | | | | | | | N | N | N | N | N | N | | | | | J | J | M | P | Q | Q | Q | | | | |
| | 0.47 | | | | | | | | | | J* | | | | N | N | N | N | N | N | | | | | M | M | M | P | Q | Q | Q | | | | |
| | 0.68 | | | | | | | | | | J* | | | | N | N | N | N | N | N | | | | | M | M | Q | Q | Q | Q | Q | | | | |
| | 1.0 | | | | | | | | | | J* | J* | | | N | N | N | | | | | | | | M | M | Q | Q | Q | Q | Q | | | | |
| | 1.5 | | | | | | | | | | | | | | | | | | | | | | | | P | Q | Q | Q | | | | | | | |
| | 2.2 | | | | | | | | | | J* | | | | | | | | | | | | | | Q | Q | Q | | | | | | | | |
| | 3.3 | | | | | | | | | | | | | | | | | | | | | | | | | | | | | | | | | | |
| | 4.7 | | | | | | | | | | | | | | | | | | | | | | | | | | | | | | | | | | |
| | 10 | | | | | | | | | | | | | | | | | | | | | | | | | | | | | | | | | | |
| | 22 | | | | | | | | | | | | | | | | | | | | | | | | | | | | | | | | | | |
| | 47 | | | | | | | | | | | | | | | | | | | | | | | | | | | | | | | | | | |
| | 100 | | | | | | | | | | | | | | | | | | | | | | | | | | | | | | | | | | |
| WVDC | 10 | 16 | 25 | 16 | 25 | 50 | 6.3 | 10 | 16 | 25 | 50 | 100 | 200 | 6.3 | 10 | 16 | 25 | 50 | 100 | 200 | 6.3 | 10 | 16 | 25 | 50 | 100 | 200 | 6.3 | 10 | 16 | 25 | 50 | 100 | 200 | 500 |
| SIZE | 0201 | | | 0402 | | | 0603 | | | | | | 0805 | | | | | | 1206 | | | | | | | | | | | | | | | | |

| Letter | A | C | E | G | J | K | M | N | P | Q | X | Y | Z |
|----------------|-----------------|-----------------|-----------------|-----------------|-----------------|-----------------|-----------------|-----------------|-----------------|-----------------|-----------------|-----------------|-----------------|
| Max. Thickness | 0.33 (0.013) | 0.56 (0.022) | 0.71 (0.028) | 0.90 (0.035) | 0.94 (0.037) | 1.02 (0.040) | 1.27 (0.050) | 1.40 (0.055) | 1.52 (0.060) | 1.78 (0.070) | 2.29 (0.090) | 2.54 (0.100) | 2.79 (0.110) |
| | PAPER | | | | | EMBOSSSED | | | | | | | |

*Optional Specifications – Contact factory



X7R Dielectric



Capacitance Range

PREFERRED SIZES ARE SHADED

| SIZE | 1210 | | | | | | | 1812 | | | | 1825 | | 2220 | | | | 2225 | | |
|-------------------------|--------------------------------|----|----|----|-----|-----|-----|--------------------------------|-----|-----|-----|--------------------------------|-----|--------------------------------|----|-----|-----|--------------------------------|-----|---|
| | Reflow Only | | | | | | | Reflow Only | | | | Reflow Only | | Reflow Only | | | | Reflow Only | | |
| Soldering | Paper/Embossed | | | | | | | All Embossed | | | | All Embossed | | All Embossed | | | | All Embossed | | |
| Packaging | Paper/Embossed | | | | | | | All Embossed | | | | All Embossed | | All Embossed | | | | All Embossed | | |
| (L) Length (mm (in.)) | 3.20 ± 0.20 (0.126 ± 0.008) | | | | | | | 4.50 ± 0.30 (0.177 ± 0.012) | | | | 4.50 ± 0.30 (0.177 ± 0.012) | | 5.70 ± 0.40 (0.225 ± 0.016) | | | | 5.72 ± 0.25 (0.225 ± 0.010) | | |
| (W) Width (mm (in.)) | 2.50 ± 0.20 (0.098 ± 0.008) | | | | | | | 3.20 ± 0.20 (0.126 ± 0.008) | | | | 6.40 ± 0.40 (0.252 ± 0.016) | | 5.00 ± 0.40 (0.197 ± 0.016) | | | | 6.35 ± 0.25 (0.250 ± 0.010) | | |
| (t) Terminal (mm (in.)) | 0.50 ± 0.25 (0.020 ± 0.010) | | | | | | | 0.61 ± 0.36 (0.024 ± 0.014) | | | | 0.61 ± 0.36 (0.024 ± 0.014) | | 0.64 ± 0.39 (0.025 ± 0.015) | | | | 0.64 ± 0.39 (0.025 ± 0.015) | | |
| WVDC | 10 | 16 | 25 | 50 | 100 | 200 | 500 | 50 | 100 | 200 | 500 | 50 | 100 | 25 | 50 | 100 | 200 | 50 | 100 | |
| Cap (pF) | 100 | | | | | | | | | | | | | | | | | | | |
| | 150 | | | | | | | | | | | | | | | | | | | |
| | 220 | | | | | | | | | | | | | | | | | | | |
| | 330 | | | | | | | | | | | | | | | | | | | |
| | 470 | | | | | | | | | | | | | | | | | | | |
| | 680 | | | | | | | | | | | | | | | | | | | |
| | 1000 | | | | | | | | | | | | | | | | | | | |
| | 1500 | J | J | J | J | J | J | M | | | | | | | | | | | | |
| | 2200 | J | J | J | J | J | J | M | | | | | | | | | | | | |
| | 3300 | J | J | J | J | J | J | M | | | | | | | | | | | | |
| | 4700 | J | J | J | J | J | J | M | | | | | | | | | | | | |
| | 6800 | J | J | J | J | J | J | M | | | | | | | | | | | | |
| Cap (µF) | 0.010 | J | J | J | J | J | J | M | K | K | K | K | M | M | | X | X | X | M | P |
| | 0.015 | J | J | J | J | J | J | P | K | K | K | P | M | M | | X | X | X | M | P |
| | 0.022 | J | J | J | J | J | J | Q | K | K | K | P | M | M | | X | X | X | M | P |
| | 0.033 | J | J | J | J | J | J | Q | K | K | K | X | M | M | | X | X | X | M | P |
| | 0.047 | J | J | J | J | J | J | | K | K | K | Z | M | M | | X | X | X | M | P |
| | 0.068 | J | J | J | J | J | M | | K | K | K | Z | M | M | | X | X | X | M | P |
| | 0.10 | J | J | J | J | J | M | | K | K | K | Z | M | M | | X | X | X | M | P |
| | 0.15 | J | J | J | J | M | Z | | K | K | P | | M | M | | X | X | X | M | P |
| | 0.22 | J | J | J | J | P | Z | | K | K | P | | M | M | | X | X | X | M | P |
| | 0.33 | J | J | J | J | Q | | | K | M | X | | M | M | | X | X | X | M | P |
| | 0.47 | M | M | M | M | Q | | | K | P | | | M | M | | X | X | X | M | P |
| | 0.68 | M | M | P | X | X | | | M | Q | | | M | P | | X | X | | M | P |
| | 1.0 | N | N | P | X | Z | | | M | X | | | M | P | | X | X | | M | P |
| | 1.5 | N | N | Z | Z | Z | | | Z | Z | | | M | | | X | X | | M | X |
| | 2.2 | X | X | Z | Z | Z | | | Z | Z | | | | | | X | X | | M | |
| | 3.3 | X | X | Z | Z | | | | Z | | | | | | | X | Z | | | |
| | 4.7 | X | X | Z | Z | | | | Z | | | | | | | X | Z | | | |
| | 10 | Z | Z | Z* | | | | | | | | | | | | Z | | | | |
| | 22 | Z* | Z* | | | | | | | | | | | | Z | | | | | |
| | 47 | | | | | | | | | | | | | | | | | | | |
| | 100 | | | | | | | | | | | | | | | | | | | |
| WVDC | 10 | 16 | 25 | 50 | 100 | 200 | 500 | 50 | 100 | 200 | 500 | 50 | 100 | 25 | 50 | 100 | 200 | 50 | 100 | |

| Letter | A | C | E | G | J | K | M | N | P | Q | X | Y | Z |
|----------------|-----------------|-----------------|-----------------|-----------------|-----------------|-----------------|-----------------|-----------------|-----------------|-----------------|-----------------|-----------------|-----------------|
| Max. Thickness | 0.33 (0.013) | 0.56 (0.022) | 0.71 (0.028) | 0.90 (0.035) | 0.94 (0.037) | 1.02 (0.040) | 1.27 (0.050) | 1.40 (0.055) | 1.52 (0.060) | 1.78 (0.070) | 2.29 (0.090) | 2.54 (0.100) | 2.79 (0.110) |
| | PAPER | | | | | EMBOSS | | | | | | | |

*Optional Specifications – Contact factory

X7S Dielectric

General Specifications

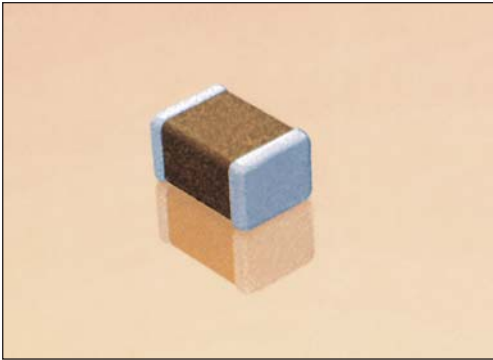

GENERAL DESCRIPTION

X7S formulations are called “temperature stable” ceramics and fall into EIA Class II materials. Its temperature variation of capacitance is within $\pm 22\%$ from -55°C to $+125^{\circ}\text{C}$. This capacitance change is non-linear.

Capacitance for X7S varies under the influence of electrical operating conditions such as voltage and frequency.

X7S dielectric chip usage covers the broad spectrum of industrial applications where known changes in capacitance due to applied voltages are acceptable.

PART NUMBER (see page 2 for complete part number explanation)

1206

Size
(L" x W")

Z

Voltage
4 = 4V
6 = 6.3V
Z = 10V
Y = 16V
3 = 25V
5 = 50V
1 = 100V
2 = 200V

Z

Dielectric
Z = X7S

105

Capacitance Code (In pF)
2 Sig. Digits + Number of Zeros

M

Capacitance Tolerance
K = $\pm 10\%$
M = $\pm 20\%$

A

Failure Rate
A = N/A

T

Terminations
T = Plated Ni and Sn

2

Packaging
2 = 7" Reel
4 = 13" Reel
7 = Bulk Cass.

A

Special Code
A = Std. Product

NOTE: Contact factory for availability of Tolerance Options for Specific Part Numbers.

TYPICAL ELECTRICAL CHARACTERISTICS

X7S Dielectric Typical Temperature Coefficient

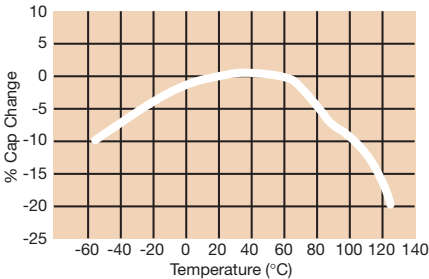

Δ Capacitance vs. Frequency

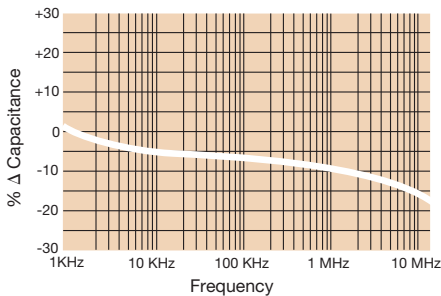

Insulation Resistance vs Temperature

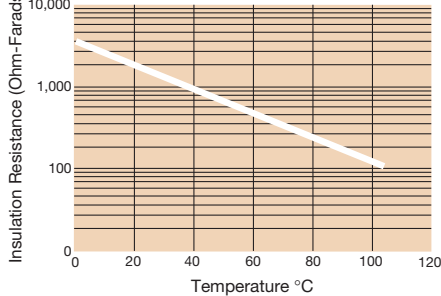

Variation of Impedance with Cap Value Impedance vs. Frequency 1,000 pF vs. 10,000 pF - X7S 0805

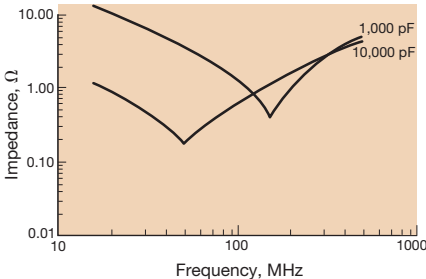

Variation of Impedance with Chip Size Impedance vs. Frequency 10,000 pF - X7S

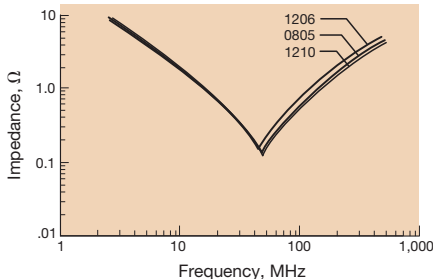

Variation of Impedance with Chip Size Impedance vs. Frequency 100,000 pF - X7S

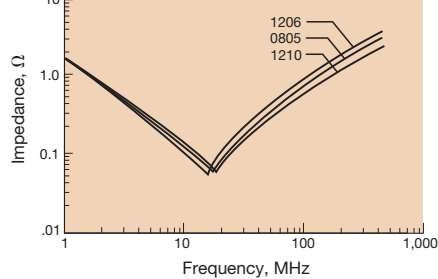

X7S Dielectric

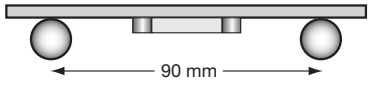

Specifications and Test Methods

| Parameter/Test | | X7S Specification Limits | Measuring Conditions | |
|---------------------------------------|-----------------------|--|---|----------------|
| Operating Temperature Range | | -55°C to +125°C | Temperature Cycle Chamber | |
| Capacitance | | Within specified tolerance | Freq.: 1.0 kHz ± 10% Voltage: 1.0Vrms ± .2V For Cap > 10 µF, 0.5Vrms @ 120Hz | |
| Dissipation Factor | | ≤ 2.5% for ≥ 50V DC rating ≤ 3.0% for 25V DC rating ≤ 3.5% for 16V DC rating ≤ 5.0% for ≤ 10V DC rating | | |
| Insulation Resistance | | 100,000MΩ or 1000MΩ - µF, whichever is less | Charge device with rated voltage for 120 ± 5 secs @ room temp/humidity | |
| Dielectric Strength | | No breakdown or visual defects | Charge device with 300% of rated voltage for 1-5 seconds, w/charge and discharge current limited to 50 mA (max) | |
| Resistance to Flexure Stresses | Appearance | No defects | Deflection: 2mm Test Time: 30 seconds 1mm/sec  | |
| | Capacitance Variation | ≤ ±12% | | |
| | Dissipation Factor | Meets Initial Values (As Above) | | |
| | Insulation Resistance | ≥ Initial Value x 0.3 | | |
| Solderability | | ≥ 95% of each terminal should be covered with fresh solder | Dip device in eutectic solder at 230 ± 5°C for 5.0 ± 0.5 seconds | |
| Resistance to Solder Heat | Appearance | No defects, <25% leaching of either end terminal | Dip device in eutectic solder at 260°C for 60 seconds. Store at room temperature for 24 ± 2 hours before measuring electrical properties. | |
| | Capacitance Variation | ≤ ±7.5% | | |
| | Dissipation Factor | Meets Initial Values (As Above) | | |
| | Insulation Resistance | Meets Initial Values (As Above) | | |
| | Dielectric Strength | Meets Initial Values (As Above) | | |
| Thermal Shock | Appearance | No visual defects | Step 1: -55°C ± 2° | 30 ± 3 minutes |
| | Capacitance Variation | ≤ ±7.5% | Step 2: Room Temp | ≤ 3 minutes |
| | Dissipation Factor | Meets Initial Values (As Above) | Step 3: +125°C ± 2° | 30 ± 3 minutes |
| | Insulation Resistance | Meets Initial Values (As Above) | Step 4: Room Temp | ≤ 3 minutes |
| | Dielectric Strength | Meets Initial Values (As Above) | Repeat for 5 cycles and measure after 24 ± 2 hours at room temperature | |
| Load Life | Appearance | No visual defects | Charge device with 1.5 rated voltage (≤ 10V) in test chamber set at 125°C ± 2°C for 1000 hours (+48, -0) Remove from test chamber and stabilize at room temperature for 24 ± 2 hours before measuring. | |
| | Capacitance Variation | ≤ ±12.5% | | |
| | Dissipation Factor | ≤ Initial Value x 2.0 (See Above) | | |
| | Insulation Resistance | ≥ Initial Value x 0.3 (See Above) | | |
| | Dielectric Strength | Meets Initial Values (As Above) | | |
| Load Humidity | Appearance | No visual defects | Store in a test chamber set at 85°C ± 2°C/ 85% ± 5% relative humidity for 1000 hours (+48, -0) with rated voltage applied. Remove from chamber and stabilize at room temperature and humidity for 24 ± 2 hours before measuring. | |
| | Capacitance Variation | ≤ ±12.5% | | |
| | Dissipation Factor | ≤ Initial Value x 2.0 (See Above) | | |
| | Insulation Resistance | ≥ Initial Value x 0.3 (See Above) | | |
| | Dielectric Strength | Meets Initial Values (As Above) | | |

X7S Dielectric

Capacitance Range



PREFERRED SIZES ARE SHADED

| SIZE | 0402 | 0603 | 0805 | 1206 | 1210 |
|------------------|-------------|-------------|----------------|----------------|----------------|
| Soldering | Reflow/Wave | Reflow/Wave | Reflow/Wave | Reflow/Wave | Reflow Only |
| Packaging | All Paper | All Paper | Paper/Embossed | Paper/Embossed | Paper/Embossed |
| (L) Length | mm (in.) | mm (in.) | mm (in.) | mm (in.) | mm (in.) |
| (W) Width | mm (in.) | mm (in.) | mm (in.) | mm (in.) | mm (in.) |
| (t) Terminal | mm (in.) | mm (in.) | mm (in.) | mm (in.) | mm (in.) |
| WVDC | 6.3 | 6.3 25 | 4 | 6.3 10 | 6.3 |
| Cap (pF) | | | | | |
| 100 | | | | | |
| 150 | | | | | |
| 220 | | | | | |
| 330 | | | | | |
| 470 | | | | | |
| 680 | | | | | |
| 1000 | | | | | |
| 1500 | | | | | |
| 2200 | | | | | |
| Cap (µF) | | | | | |
| 0.010 | | | | | |
| 0.015 | | | | | |
| 0.022 | | | | | |
| 0.033 | C | | | | |
| 0.047 | C | | | | |
| 0.068 | C | | | | |
| 0.10 | C | | | | |
| 0.15 | | | | | |
| 0.22 | | G | | | |
| 0.33 | | G | | | |
| 0.47 | | G | | | |
| 0.68 | | G | | | |
| 1.0 | | G | | | |
| 1.5 | | | N | Q | |
| 2.2 | | | N | Q | |
| 3.3 | | | N | Q | |
| 4.7 | | | N | Q | Q |
| 10 | | | | | |
| 22 | | | | | Z |
| 47 | | | | | |
| 100 | | | | | |
| WVDC | 6.3 | 6.3 25 | 4 | 6.3 10 | 6.3 |
| SIZE | 0402 | 0603 | 0805 | 1206 | 1210 |

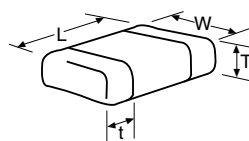

| Letter | A | C | E | G | J | K | M | N | P | Q | X | Y | Z |
|-----------------------|-----------------|-----------------|-----------------|-----------------|-----------------|-----------------|-----------------|-----------------|-----------------|-----------------|-----------------|-----------------|-----------------|
| Max. Thickness | 0.33 (0.013) | 0.56 (0.022) | 0.71 (0.028) | 0.90 (0.035) | 0.94 (0.037) | 1.02 (0.040) | 1.27 (0.050) | 1.40 (0.055) | 1.52 (0.060) | 1.78 (0.070) | 2.29 (0.090) | 2.54 (0.100) | 2.79 (0.110) |
| | PAPER | | | | | EMBOSSSED | | | | | | | |

X5R Dielectric

General Specifications

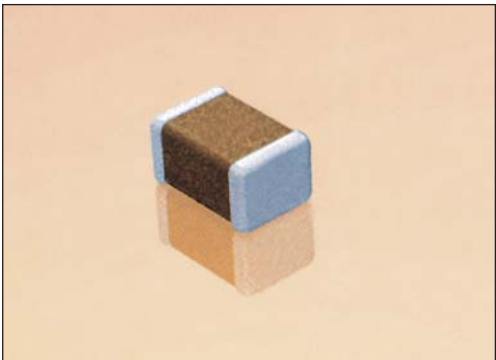

GENERAL DESCRIPTION

- General Purpose Dielectric for Ceramic Capacitors
- EIA Class II Dielectric
- Temperature variation of capacitance is within $\pm 15\%$ from -55°C to $+85^{\circ}\text{C}$
- Well suited for decoupling and filtering applications
- Available in High Capacitance values (up to $100\mu\text{F}$)

PART NUMBER (see page 2 for complete part number explanation)

1210

Size
(L" x W")

4

Voltage
4 = 4V
6 = 6.3V
Z = 10V
Y = 16V
3 = 25V
D = 35V
5 = 50V

D

Dielectric
D = X5R

107

Capacitance Code (In pF)
2 Sig. Digits +
Number of
Zeros

M

Capacitance Tolerance
K = $\pm 10\%$
M = $\pm 20\%$

A

Failure Rate
A = N/A

T

Terminations
T = Plated Ni
and Sn

2

Packaging
2 = 7" Reel
4 = 13" Reel
7 = Bulk Cass.
9 = Bulk

A

Special Code
A = Std.

NOTE: Contact factory for availability of Tolerance Options for Specific Part Numbers.
Contact factory for non-specified capacitance values.

TYPICAL ELECTRICAL CHARACTERISTICS

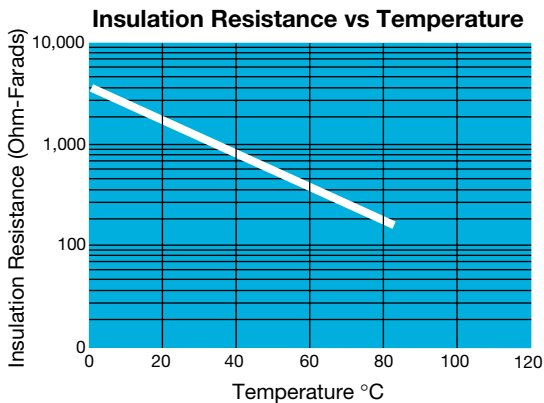
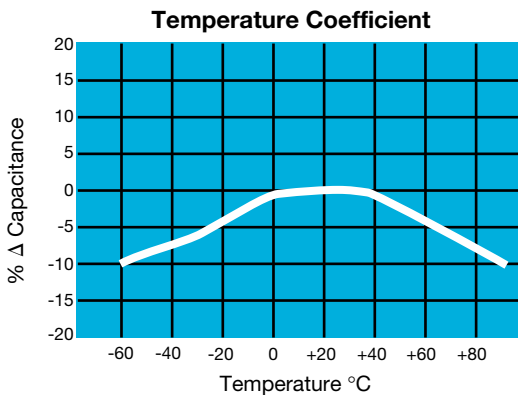

Specifications and Test Methods

| Parameter/Test | | X5R Specification Limits | Measuring Conditions | |
|---------------------------------------|-----------------------|--|--|--------------------|
| Operating Temperature Range | | -55°C to +85°C | Temperature Cycle Chamber | |
| Capacitance | | Within specified tolerance | Freq.: 1.0 kHz \pm 10% Voltage: 1.0Vrms \pm .2V For Cap > 10 μ F, 0.5Vrms @ 120Hz | |
| Dissipation Factor | | \leq 2.5% for \geq 50V DC rating \leq 3.0% for 25V DC rating \leq 12.5% Max. for 16V DC rating and lower Contact Factory for DF by PN | | |
| Insulation Resistance | | 10,000M Ω or 500M Ω - μ F, whichever is less | Charge device with rated voltage for 120 \pm 5 secs @ room temp/humidity | |
| Dielectric Strength | | No breakdown or visual defects | Charge device with 300% of rated voltage for 1-5 seconds, w/charge and discharge current limited to 50 mA (max) | |
| Resistance to Flexure Stresses | Appearance | No defects | Deflection: 2mm Test Time: 30 seconds | |
| | Capacitance Variation | \leq \pm 12% | | |
| | Dissipation Factor | Meets Initial Values (As Above) | | |
| | Insulation Resistance | \geq Initial Value x 0.3 | | |
| Solderability | | \geq 95% of each terminal should be covered with fresh solder | Dip device in eutectic solder at 230 \pm 5°C for 5.0 \pm 0.5 seconds | |
| Resistance to Solder Heat | Appearance | No defects, <25% leaching of either end terminal | Dip device in eutectic solder at 260°C for 60 seconds. Store at room temperature for 24 \pm 2 hours before measuring electrical properties. | |
| | Capacitance Variation | \leq \pm 7.5% | | |
| | Dissipation Factor | Meets Initial Values (As Above) | | |
| | Insulation Resistance | Meets Initial Values (As Above) | | |
| | Dielectric Strength | Meets Initial Values (As Above) | | |
| Thermal Shock | Appearance | No visual defects | Step 1: -55°C \pm 2° | 30 \pm 3 minutes |
| | Capacitance Variation | \leq \pm 7.5% | Step 2: Room Temp | \leq 3 minutes |
| | Dissipation Factor | Meets Initial Values (As Above) | Step 3: +85°C \pm 2° | 30 \pm 3 minutes |
| | Insulation Resistance | Meets Initial Values (As Above) | Step 4: Room Temp | \leq 3 minutes |
| | Dielectric Strength | Meets Initial Values (As Above) | Repeat for 5 cycles and measure after 24 \pm 2 hours at room temperature | |
| Load Life | Appearance | No visual defects | Charge device with 1.5X rated voltage in test chamber set at 85°C \pm 2°C for 1000 hours (+48, -0). Note: Contact factory for *optional specification part numbers that are tested at < 1.5X rated voltage. Remove from test chamber and stabilize at room temperature for 24 \pm 2 hours before measuring. | |
| | Capacitance Variation | \leq \pm 12.5% | | |
| | Dissipation Factor | \leq Initial Value x 2.0 (See Above) | | |
| | Insulation Resistance | \geq Initial Value x 0.3 (See Above) | | |
| | Dielectric Strength | Meets Initial Values (As Above) | | |
| Load Humidity | Appearance | No visual defects | Store in a test chamber set at 85°C \pm 2°C/ 85% \pm 5% relative humidity for 1000 hours (+48, -0) with rated voltage applied. Remove from chamber and stabilize at room temperature and humidity for 24 \pm 2 hours before measuring. | |
| | Capacitance Variation | \leq \pm 12.5% | | |
| | Dissipation Factor | \leq Initial Value x 2.0 (See Above) | | |
| | Insulation Resistance | \geq Initial Value x 0.3 (See Above) | | |
| | Dielectric Strength | Meets Initial Values (As Above) | | |

X5R Dielectric



Capacitance Range

PREFERRED SIZES ARE SHADED

| SIZE | 0201 | | | | | 0402 | | | | | 0603 | | | | | 0805 | | | | | 1206 | | | | | 1210 | | | | | 1812 | | | | | | | | | | | | | | | | | |
|-------------------|--------------------------------|-----|----|----|----|--------------------------------|-----|----|----|----|--------------------------------|---|-----|----|----|--------------------------------|----|----|-----|----|--------------------------------|----|----|----|-----|--------------------------------|----|----|----|----|--------------------------------|-----|----|----|----|----|----|---|-----|----|----|----|----|----|-----|----|----|----|
| Soldering | Reflow Only | | | | | Reflow/Wave | | | | | Reflow/Wave | | | | | Reflow/Wave | | | | | Reflow/Wave | | | | | Reflow Only | | | | | Reflow Only | | | | | | | | | | | | | | | | | |
| Packaging | All Paper | | | | | All Paper | | | | | All Paper | | | | | Paper/Embossed | | | | | Paper/Embossed | | | | | Paper/Embossed | | | | | All Embossed | | | | | | | | | | | | | | | | | |
| (L) Length (mm) | 0.60 ± 0.03 (0.024 ± 0.001) | | | | | 1.00 ± 0.10 (0.040 ± 0.004) | | | | | 1.60 ± 0.15 (0.063 ± 0.006) | | | | | 2.01 ± 0.20 (0.079 ± 0.008) | | | | | 3.20 ± 0.20 (0.126 ± 0.008) | | | | | 3.20 ± 0.20 (0.126 ± 0.008) | | | | | 4.50 ± 0.30 (0.177 ± 0.012) | | | | | | | | | | | | | | | | | |
| (W) Width (mm) | 0.30 ± 0.03 (0.011 ± 0.001) | | | | | 0.50 ± 0.10 (0.020 ± 0.004) | | | | | 0.81 ± 0.15 (0.032 ± 0.006) | | | | | 1.25 ± 0.20 (0.049 ± 0.008) | | | | | 1.60 ± 0.20 (0.063 ± 0.008) | | | | | 2.50 ± 0.20 (0.098 ± 0.008) | | | | | 3.20 ± 0.20 (0.126 ± 0.008) | | | | | | | | | | | | | | | | | |
| (t) Terminal (mm) | 0.15 ± 0.05 (0.006 ± 0.002) | | | | | 0.25 ± 0.15 (0.010 ± 0.006) | | | | | 0.35 ± 0.15 (0.014 ± 0.006) | | | | | 0.50 ± 0.25 (0.020 ± 0.010) | | | | | 0.50 ± 0.25 (0.020 ± 0.010) | | | | | 0.50 ± 0.25 (0.020 ± 0.010) | | | | | 0.61 ± 0.36 (0.024 ± 0.014) | | | | | | | | | | | | | | | | | |
| WVDC | 4 | 6.3 | 10 | 16 | 25 | 4 | 6.3 | 10 | 16 | 25 | 50 | 4 | 6.3 | 10 | 16 | 25 | 35 | 50 | 6.3 | 10 | 16 | 25 | 35 | 50 | 6.3 | 10 | 16 | 25 | 35 | 50 | 4 | 6.3 | 10 | 16 | 25 | 35 | 50 | 4 | 6.3 | 10 | 16 | 25 | 35 | 50 | 6.3 | 10 | 25 | 50 |
| Cap (pF) | A | | | | | C | | | | | G | | | | | N | | | | | Q | | | | | X | | | | | Z | | | | | | | | | | | | | | | | | |
| Cap (μF) | A* | | | | | C* | | | | | G* | | | | | N* | | | | | Q* | | | | | X* | | | | | Z* | | | | | | | | | | | | | | | | | |

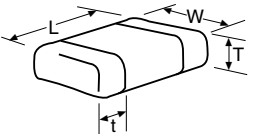

| Letter | A | C | E | G | J | K | M | N | P | Q | X | Y | Z |
|----------------|-----------------|-----------------|-----------------|-----------------|-----------------|-----------------|-----------------|-----------------|-----------------|-----------------|-----------------|-----------------|-----------------|
| Max. Thickness | 0.33 (0.013) | 0.56 (0.022) | 0.71 (0.028) | 0.90 (0.035) | 0.94 (0.037) | 1.02 (0.040) | 1.27 (0.050) | 1.40 (0.055) | 1.52 (0.060) | 1.78 (0.070) | 2.29 (0.090) | 2.54 (0.100) | 2.79 (0.110) |
| | PAPER | | | | | EMBOSSED | | | | | | | |

■ = Under Development

■ = *Optional Specifications – Contact factory

NOTE: Contact factory for non-specified capacitance values

Y5V Dielectric

General Specifications

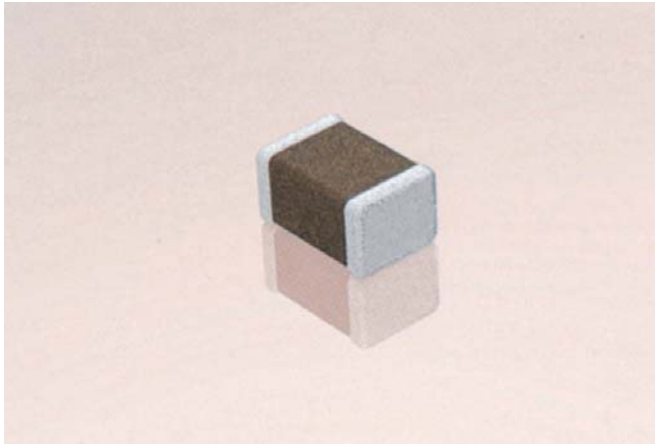

Y5V formulations are for general-purpose use in a limited temperature range. They have a wide temperature characteristic of +22% -82% capacitance change over the operating temperature range of -30°C to +85°C.

These characteristics make Y5V ideal for decoupling applications within limited temperature range.

PART NUMBER (see page 2 for complete part number explanation)

0805

Size
(L" x W")

3

Voltage
6.3V = 6
10V = Z
16V = Y
25V = 3
50V = 5

G

Dielectric
Y5V = G

104

Capacitance Code (In pF)
2 Sig. Digits + Number of Zeros

Z

Capacitance Tolerance
Z = +80 -20%

A

Failure Rate
A = Not Applicable

T

Terminations
T = Plated Ni and Sn

2

Packaging
2 = 7" Reel
4 = 13" Reel

A

Special Code
A = Std. Product

Temperature Coefficient

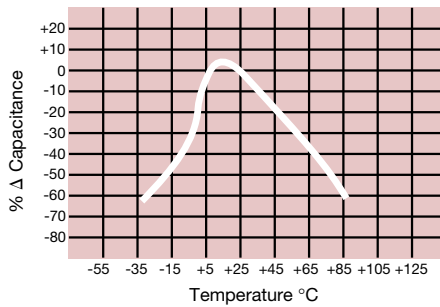

Capacitance Change vs. DC Bias Voltage

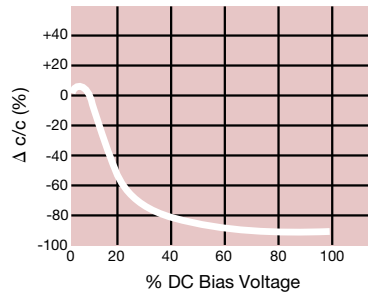

Insulation Resistance vs. Temperature

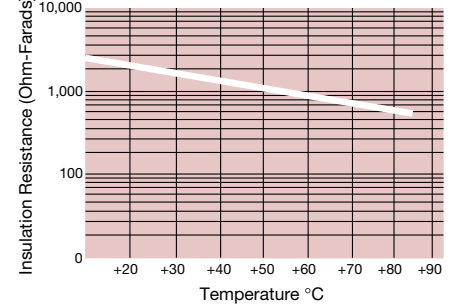

0.1 μF - 0603 Impedance vs. Frequency

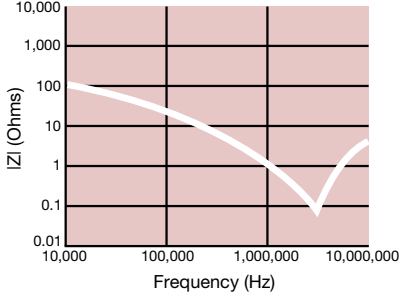

0.22 μF - 0805 Impedance vs. Frequency

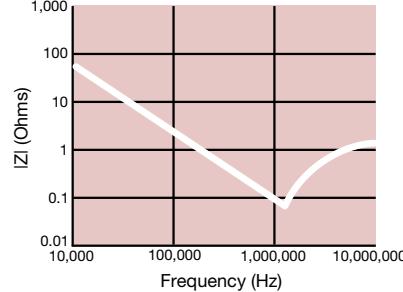

1 μF - 1206 Impedance vs. Frequency

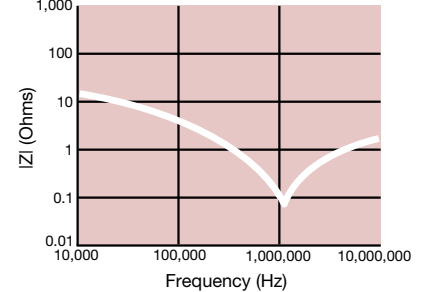

Y5V Dielectric



Specifications and Test Methods

| Parameter/Test | | Y5V Specification Limits | Measuring Conditions | |
|---------------------------------------|-----------------------|---|---|---|
| Operating Temperature Range | | -30°C to +85°C | Temperature Cycle Chamber | |
| Capacitance | | Within specified tolerance | Freq.: 1.0 kHz \pm 10% Voltage: 1.0Vrms \pm .2V For Cap > 10 μ F, 0.5Vrms @ 120Hz | |
| Dissipation Factor | | \leq 5.0% for \geq 50V DC rating \leq 7.0% for 25V DC rating \leq 9.0% for 16V DC rating \leq 12.5% for \leq 10V DC rating | | |
| Insulation Resistance | | 10,000M Ω or 500M Ω - μ F, whichever is less | Charge device with rated voltage for 120 \pm 5 secs @ room temp/humidity | |
| Dielectric Strength | | No breakdown or visual defects | Charge device with 300% of rated voltage for 1-5 seconds, w/charge and discharge current limited to 50 mA (max) | |
| Resistance to Flexure Stresses | Appearance | No defects | Deflection: 2mm Test Time: 30 seconds | |
| | Capacitance Variation | \leq \pm 30% | | |
| | Dissipation Factor | Meets Initial Values (As Above) | | |
| | Insulation Resistance | \geq Initial Value x 0.1 | | |
| Solderability | | \geq 95% of each terminal should be covered with fresh solder | Dip device in eutectic solder at 230 \pm 5°C for 5.0 \pm 0.5 seconds | |
| Resistance to Solder Heat | Appearance | No defects, <25% leaching of either end terminal | Dip device in eutectic solder at 260°C for 60 seconds. Store at room temperature for 24 \pm 2 hours before measuring electrical properties. | |
| | Capacitance Variation | \leq \pm 20% | | |
| | Dissipation Factor | Meets Initial Values (As Above) | | |
| | Insulation Resistance | Meets Initial Values (As Above) | | |
| | Dielectric Strength | Meets Initial Values (As Above) | | |
| Thermal Shock | Appearance | No visual defects | Step 1: -30°C \pm 2° | 30 \pm 3 minutes |
| | Capacitance Variation | \leq \pm 20% | Step 2: Room Temp | \leq 3 minutes |
| | Dissipation Factor | Meets Initial Values (As Above) | Step 3: +85°C \pm 2° | 30 \pm 3 minutes |
| | Insulation Resistance | Meets Initial Values (As Above) | Step 4: Room Temp | \leq 3 minutes |
| | Dielectric Strength | Meets Initial Values (As Above) | Repeat for 5 cycles and measure after 24 \pm 2 hours at room temperature | |
| | Load Life | | No visual defects | Charge device with twice rated voltage in test chamber set at 85°C \pm 2°C for 1000 hours (+48, -0) |
| Load Humidity | Capacitance Variation | \leq \pm 30% | Remove from test chamber and stabilize at room temperature for 24 \pm 2 hours before measuring. | |
| | Dissipation Factor | \leq Initial Value x 1.5 (See Above) | | |
| | Insulation Resistance | \geq Initial Value x 0.1 (See Above) | | |
| | Dielectric Strength | Meets Initial Values (As Above) | | |
| | Appearance | No visual defects | | |
| Load Humidity | Capacitance Variation | \leq \pm 30% | Store in a test chamber set at 85°C \pm 2°C/ 85% \pm 5% relative humidity for 1000 hours (+48, -0) with rated voltage applied. | |
| | Dissipation Factor | \leq Initial Value x 1.5 (See above) | | |
| | Insulation Resistance | \geq Initial Value x 0.1 (See Above) | | |
| | Dielectric Strength | Meets Initial Values (As Above) | | |
| | Appearance | No visual defects | | |
| Load Humidity | | No visual defects | Remove from chamber and stabilize at room temperature and humidity for 24 \pm 2 hours before measuring. | |

Y5V Dielectric



Capacitance Range

PREFERRED SIZES ARE SHADED

| SIZE | 0201 | | 0402 | | | | 0603 | | | | 0805 | | | | 1206 | | | | 1210 | | | |
|--------------|-------------|-----------------|-----------------|-------------|-------------|-------------|-----------------|-------------|-------------|-------------|-----------------|-------------|-------------|-------------|-----------------|-------------|-------------|--|-----------------|--|--|--|
| | Reflow Only | | Reflow/Wave | | | | Reflow/Wave | | | | Reflow/Wave | | | | Reflow/Wave | | | | Reflow Only | | | |
| Packaging | All Paper | | All Paper | | | | All Paper | | | | Paper/Embossed | | | | Paper/Embossed | | | | Paper/Embossed | | | |
| (L) Length | mm | 0.60 ± 0.03 | 1.00 ± 0.10 | | | | 1.60 ± 0.15 | | | | 2.01 ± 0.20 | | | | 3.20 ± 0.20 | | | | 3.20 ± 0.20 | | | |
| (W) Width | mm | 0.30 ± 0.03 | 0.50 ± 0.10 | | | | .81 ± 0.15 | | | | 1.25 ± 0.20 | | | | 1.60 ± 0.20 | | | | 2.50 ± 0.20 | | | |
| (t) Terminal | mm | 0.15 ± 0.05 | 0.25 ± 0.15 | | | | 0.35 ± 0.15 | | | | 0.50 ± 0.25 | | | | 0.50 ± 0.25 | | | | .50 ± 0.25 | | | |
| | (in.) | (0.024 ± 0.001) | (0.040 ± 0.004) | | | | (0.063 ± 0.006) | | | | (0.079 ± 0.008) | | | | (0.126 ± 0.008) | | | | (0.126 ± 0.008) | | | |
| | (in.) | (0.011 ± 0.001) | (0.020 ± 0.004) | | | | (0.032 ± 0.006) | | | | (0.049 ± 0.008) | | | | (0.063 ± 0.008) | | | | (0.098 ± 0.008) | | | |
| | (in.) | (0.006 ± 0.002) | (0.010 ± 0.006) | | | | (0.014 ± 0.006) | | | | (0.020 ± 0.010) | | | | (0.020 ± 0.010) | | | | (0.020 ± 0.010) | | | |
| WVDC | | 6.3 10 | 6 10 16 25 50 | 10 16 25 50 | 10 16 25 50 | 10 16 25 50 | 10 16 25 50 | 10 16 25 50 | 10 16 25 50 | 10 16 25 50 | 10 16 25 50 | 10 16 25 50 | 10 16 25 50 | 10 16 25 50 | 10 16 25 50 | 10 16 25 50 | 10 16 25 50 | | | | | |
| Cap (pF) | 820 | | | | | | | | | | | | | | | | | | | | | |
| | 1000 | A | | | | | | | | | | | | | | | | | | | | |
| | 2200 | A | | | | | | | | | | | | | | | | | | | | |
| Cap (µF) | 4700 | | | | | | | | | | | | | | | | | | | | | |
| | 0.010 | A | | | | | | | | | | | | | | | | | | | | |
| | 0.022 | A | | | | | | | | | | | | | | | | | | | | |
| | 0.047 | A | | | | | | | | | | | | | | | | | | | | |
| | 0.10 | | | | | | | | | | | | | | | | | | | | | |
| | 0.22 | | | | | | | | | | | | | | | | | | | | | |
| | 0.33 | | | | | | | | | | | | | | | | | | | | | |
| | 0.47 | | | | | | | | | | | | | | | | | | | | | |
| | 1.0 | | | | | | | | | | | | | | | | | | | | | |
| | 2.2 | | | | | | | | | | | | | | | | | | | | | |
| | 4.7 | | | | | | | | | | | | | | | | | | | | | |
| | 10.0 | | | | | | | | | | | | | | | | | | | | | |
| | 22.0 | | | | | | | | | | | | | | | | | | | | | |
| | 47.0 | | | | | | | | | | | | | | | | | | | | | |
| WVDC | | 6.3 10 | 6 10 16 25 50 | 10 16 25 50 | 10 16 25 50 | 10 16 25 50 | 10 16 25 50 | 10 16 25 50 | 10 16 25 50 | 10 16 25 50 | 10 16 25 50 | 10 16 25 50 | 10 16 25 50 | 10 16 25 50 | 10 16 25 50 | 10 16 25 50 | 10 16 25 50 | | | | | |

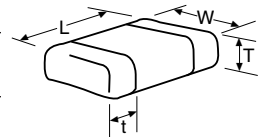

| Letter | A | C | E | G | J | K | M | N | P | Q | X | Y | Z |
|----------------|-----------------|-----------------|-----------------|-----------------|-----------------|-----------------|-----------------|-----------------|-----------------|-----------------|-----------------|-----------------|-----------------|
| Max. Thickness | 0.33 (0.013) | 0.56 (0.022) | 0.71 (0.028) | 0.90 (0.035) | 0.94 (0.037) | 1.02 (0.040) | 1.27 (0.050) | 1.40 (0.055) | 1.52 (0.060) | 1.78 (0.070) | 2.29 (0.090) | 2.54 (0.100) | 2.79 (0.110) |
| | PAPER | | | | | EMBOSSSED | | | | | | | |

MLCC Tin/Lead Termination “B”



General Specifications

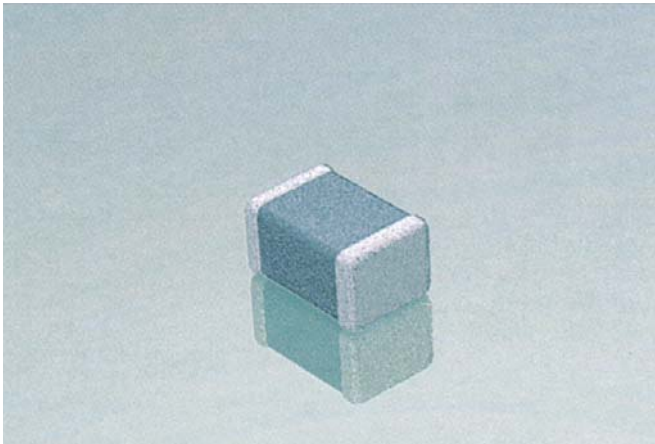

AVX Corporation will support those customers for commercial and military Multilayer Ceramic Capacitors with a termination consisting of 5% minimum lead. This termination is indicated by the use of a “B” in the 12th position of the AVX Catalog Part Number. This fulfills AVX’s commitment to providing a full range of products to our customers. AVX has provided in the following pages a full range of values that we are currently offering in this special “B” termination. Please contact the factory if you require additional information on our MLCC Tin/Lead Termination “B” products.

PART NUMBER (see page 2 for complete part number explanation)

| LD05 | 5 | A | 101 | J | A | B | 2 | A |
|---|---|--|---------------------------------------|--|-----------------------|--|---|---------------------|
| Size | Voltage | Dielectric | Capacitance Code (In pF) | Capacitance Tolerance | Failure Rate | Terminations | Packaging | Special Code |
| LD02 - 0402 LD03 - 0603 LD04 - 0504* LD05 - 0805 LD06 - 1206 LD10 - 1210 LD12 - 1812 LD13 - 1825 LD14 - 2225 LD20 - 2220 | 6.3V = 6 10V = Z 16V = Y 25V = 3 35V = D 50V = 5 100V = 1 200V = 2 500V = 7 | COG (NPO) = A X7R = C X5R = D X8R = F | 2 Sig. Digits + Number of Zeros | B = ±.10 pF (<10pF) C = ±.25 pF (<10pF) D = ±.50 pF (<10pF) F = ±1% (≥ 10 pF) G = ±2% (≥ 10 pF) J = ±5% K = ±10% M = ±20% | A = Not Applicable | B = 5% min lead X = FLEXITERM® with 5% min lead** | 2 = 7" Reel 4 = 13" Reel 7 = Bulk Cass. 9 = Bulk | A = Std. Product |
| | | | | | | **X7R only | Contact Factory For Multiples | |

*LD04 has the same CV ranges as LD03.

NOTE: Contact factory for availability of Tolerance Options for Specific Part Numbers.
Contact factory for non-specified capacitance values.

See FLEXITERM® section
for CV options

| | |
|-----|--|
| NP0 | Refer to page 4 for Electrical Graphs |
| X7R | Refer to page 16 for Electrical Graphs |
| X7S | Refer to page 20 for Electrical Graphs |
| X5R | Refer to page 23 for Electrical Graphs |
| Y5V | Refer to page 26 for Electrical Graphs |

MLCC Tin/Lead Termination "B"



Capacitance Range (NP0 Dielectric)

PREFERRED SIZES ARE SHADED

| SIZE | LD02 | | | LD03 | | | LD05 | | | | LD06 | | | | | | | | |
|--------------|-------------|--------------------------------|----|--------------------------------|------|--------------------------------|----------------|------|----|--------------------------------|----------------|------|-----|----|----|----|-----|-----|-----|
| Soldering | Reflow/Wave | | | Reflow/Wave | | | Reflow/Wave | | | | Reflow/Wave | | | | | | | | |
| Packaging | All Paper | | | All Paper | | | Paper/Embossed | | | | Paper/Embossed | | | | | | | | |
| (L) Length | mm | 1.00 ± 0.10 (0.040 ± 0.004) | | 1.60 ± 0.15 (0.063 ± 0.006) | | 2.01 ± 0.20 (0.079 ± 0.008) | | | | 3.20 ± 0.20 (0.126 ± 0.008) | | | | | | | | | |
| (W) Width | mm | 0.50 ± 0.10 (0.020 ± 0.004) | | 0.81 ± 0.15 (0.032 ± 0.006) | | 1.25 ± 0.20 (0.049 ± 0.008) | | | | 1.60 ± 0.20 (0.063 ± 0.008) | | | | | | | | | |
| (t) Terminal | mm | 0.25 ± 0.15 (0.010 ± 0.006) | | 0.35 ± 0.15 (0.014 ± 0.006) | | 0.50 ± 0.25 (0.020 ± 0.010) | | | | 0.50 ± 0.25 (0.020 ± 0.010) | | | | | | | | | |
| WDC | | 16 | 25 | 50 | 16 | 25 | 50 | 100 | 16 | 25 | 50 | 100 | 200 | 16 | 25 | 50 | 100 | 200 | 500 |
| Cap (pF) | 0.5 | C | C | C | G | G | G | G | J | J | J | J | J | J | J | J | J | J | J |
| | 1.0 | C | C | C | G | G | G | G | J | J | J | J | J | J | J | J | J | J | J |
| | 1.2 | C | C | C | G | G | G | G | J | J | J | J | J | J | J | J | J | J | J |
| | 1.5 | C | C | C | G | G | G | G | J | J | J | J | J | J | J | J | J | J | J |
| | 1.8 | C | C | C | G | G | G | G | J | J | J | J | J | J | J | J | J | J | J |
| | 2.2 | C | C | C | G | G | G | G | J | J | J | J | J | J | J | J | J | J | J |
| | 2.7 | C | C | C | G | G | G | G | J | J | J | J | J | J | J | J | J | J | J |
| | 3.3 | C | C | C | G | G | G | G | J | J | J | J | J | J | J | J | J | J | J |
| | 3.9 | C | C | C | G | G | G | G | J | J | J | J | J | J | J | J | J | J | J |
| | 4.7 | C | C | C | G | G | G | G | J | J | J | J | J | J | J | J | J | J | J |
| | 5.6 | C | C | C | G | G | G | G | J | J | J | J | J | J | J | J | J | J | J |
| | 6.8 | C | C | C | G | G | G | G | J | J | J | J | J | J | J | J | J | J | J |
| | 8.2 | C | C | C | G | G | G | G | J | J | J | J | J | J | J | J | J | J | J |
| | 10 | C | C | C | G | G | G | G | J | J | J | J | J | J | J | J | J | J | J |
| | 12 | C | C | C | G | G | G | G | J | J | J | J | J | J | J | J | J | J | J |
| | 15 | C | C | C | G | G | G | G | J | J | J | J | J | J | J | J | J | J | J |
| | 18 | C | C | C | G | G | G | G | J | J | J | J | J | J | J | J | J | J | J |
| | 22 | C | C | C | G | G | G | G | J | J | J | J | J | J | J | J | J | J | J |
| | 27 | C | C | C | G | G | G | G | J | J | J | J | J | J | J | J | J | J | J |
| | 33 | C | C | C | G | G | G | G | J | J | J | J | J | J | J | J | J | J | J |
| | 39 | C | C | C | G | G | G | G | J | J | J | J | J | J | J | J | J | J | J |
| | 47 | C | C | C | G | G | G | G | J | J | J | J | J | J | J | J | J | J | J |
| | 56 | C | C | C | G | G | G | G | J | J | J | J | J | J | J | J | J | J | J |
| | 68 | C | C | C | G | G | G | G | J | J | J | J | J | J | J | J | J | J | J |
| | 82 | C | C | C | G | G | G | G | J | J | J | J | J | J | J | J | J | J | J |
| | 100 | C | C | C | G | G | G | G | J | J | J | J | J | J | J | J | J | J | J |
| | 120 | C | C | C | G | G | G | G | J | J | J | J | J | J | J | J | J | J | J |
| | 150 | C | C | C | G | G | G | G | J | J | J | J | J | J | J | J | J | J | J |
| | 180 | C | C | C | G | G | G | G | J | J | J | J | J | J | J | J | J | J | J |
| | 220 | C | C | C | G | G | G | G | J | J | J | J | J | J | J | J | J | J | M |
| | 270 | C | C | C | G | G | G | G | J | J | J | J | M | J | J | J | J | J | M |
| | 330 | C | C | C | G | G | G | G | J | J | J | J | M | J | J | J | J | J | M |
| | 390 | C | C | C | G | G | G | G | J | J | J | J | M | J | J | J | J | J | M |
| | 470 | C | C | C | G | G | G | G | J | J | J | J | M | J | J | J | J | J | M |
| | 560 | | | | G | G | G | G | J | J | J | J | M | J | J | J | J | J | M |
| | 680 | | | | G | G | G | G | J | J | J | J | | J | J | J | J | J | P |
| | 820 | | | | G | G | G | G | J | J | J | J | | J | J | J | J | M | |
| | 1000 | | | | G | G | G | G | J | J | J | J | | J | J | J | J | J | Q |
| | 1200 | | | | | | | | J | J | J | J | | J | J | J | J | J | Q |
| | 1500 | | | | | | | | J | J | J | J | | J | J | J | M | J | Q |
| | 1800 | | | | | | | | J | J | J | J | | J | J | M | M | | |
| | 2200 | | | | | | | | J | J | N | J | | J | J | M | P | | |
| | 2700 | | | | | | | | J | J | N | J | | J | J | M | P | | |
| | 3300 | | | | | | | | J | J | | | | J | J | M | P | | |
| | 3900 | | | | | | | | J | J | | | | J | J | M | P | | |
| | 4700 | | | | | | | | J | J | | | | J | J | M | P | | |
| | 5600 | | | | | | | | | | | | | J | J | M | | | |
| | 6800 | | | | | | | | | | | | | M | M | | | | |
| | 8200 | | | | | | | | | | | | | M | M | | | | |
| Cap (µF) | 0.010 | | | | | | | | | | | | | M | M | | | | |
| | 0.012 | | | | | | | | | | | | | | | | | | |
| | 0.015 | | | | | | | | | | | | | | | | | | |
| | 0.018 | | | | | | | | | | | | | | | | | | |
| | 0.022 | | | | | | | | | | | | | | | | | | |
| | 0.027 | | | | | | | | | | | | | | | | | | |
| | 0.033 | | | | | | | | | | | | | | | | | | |
| | 0.039 | | | | | | | | | | | | | | | | | | |
| | 0.047 | | | | | | | | | | | | | | | | | | |
| | 0.068 | | | | | | | | | | | | | | | | | | |
| | 0.082 | | | | | | | | | | | | | | | | | | |
| | 0.1 | | | | | | | | | | | | | | | | | | |
| WDC | | 16 | 25 | 50 | 16 | 25 | 50 | 100 | 16 | 25 | 50 | 100 | 200 | 16 | 25 | 50 | 100 | 200 | 500 |
| SIZE | | LD02 | | | LD03 | | | LD05 | | | | LD06 | | | | | | | |

| Letter | A | C | E | G | J | K | M | N | P | Q | X | Y | Z |
|----------------|-----------------|-----------------|-----------------|-----------------|-----------------|-----------------|-----------------|-----------------|-----------------|-----------------|-----------------|-----------------|-----------------|
| Max. Thickness | 0.33 (0.013) | 0.56 (0.022) | 0.71 (0.028) | 0.90 (0.035) | 0.94 (0.037) | 1.02 (0.040) | 1.27 (0.050) | 1.40 (0.055) | 1.52 (0.060) | 1.78 (0.070) | 2.29 (0.090) | 2.54 (0.100) | 2.79 (0.110) |
| | PAPER | | | | | EMBOSS | | | | | | | |

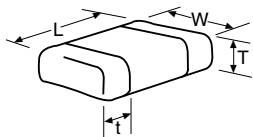

MLCC Tin/Lead Termination "B"



Capacitance Range (NP0 Dielectric)

PREFERRED SIZES ARE SHADED

| SIZE | | LD10 | | | | | LD12 | | | | | LD13 | | | LD14 | | |
|--------------|-------|--------------------------------|----|-----|-----|-----|--------------------------------|----|-----|-----|-----|--------------------------------|-----|-----|--------------------------------|-----|-----|
| Soldering | | Reflow Only | | | | | Reflow Only | | | | | Reflow Only | | | Reflow Only | | |
| Packaging | | Paper/Embossed | | | | | All Embossed | | | | | All Embossed | | | All Embossed | | |
| (L) Length | mm | 3.20 ± 0.20 (0.126 ± 0.008) | | | | | 4.50 ± 0.30 (0.177 ± 0.012) | | | | | 4.50 ± 0.30 (0.177 ± 0.012) | | | 5.72 ± 0.25 (0.225 ± 0.010) | | |
| (W) Width | mm | 2.50 ± 0.20 (0.098 ± 0.008) | | | | | 3.20 ± 0.20 (0.126 ± 0.008) | | | | | 6.40 ± 0.40 (0.252 ± 0.016) | | | 6.35 ± 0.25 (0.250 ± 0.010) | | |
| (t) Terminal | mm | 0.50 ± 0.25 (0.020 ± 0.010) | | | | | 0.61 ± 0.36 (0.024 ± 0.014) | | | | | 0.61 ± 0.36 (0.024 ± 0.014) | | | 0.64 ± 0.39 (0.025 ± 0.015) | | |
| WVDC | | 25 | 50 | 100 | 200 | 500 | 25 | 50 | 100 | 200 | 500 | 50 | 100 | 200 | 50 | 100 | 200 |
| Cap (pF) | 0.5 | | | | | | | | | | | | | | | | |
| | 1.0 | | | | | | | | | | | | | | | | |
| | 1.2 | | | | | | | | | | | | | | | | |
| | 1.5 | | | | | | | | | | | | | | | | |
| | 1.8 | | | | | | | | | | | | | | | | |
| | 2.2 | | | | | | | | | | | | | | | | |
| | 2.7 | | | | | | | | | | | | | | | | |
| | 3.3 | | | | | | | | | | | | | | | | |
| | 3.9 | | | | | | | | | | | | | | | | |
| | 4.7 | | | | | | | | | | | | | | | | |
| | 5.6 | | | | | | | | | | | | | | | | |
| | 6.8 | | | | | | | | | | | | | | | | |
| | 8.2 | | | | | | | | | | | | | | | | |
| | 10 | | | | | J | | | | | | | | | | | |
| | 12 | | | | | J | | | | | | | | | | | |
| | 15 | | | | | J | | | | | | | | | | | |
| | 18 | | | | | J | | | | | | | | | | | |
| | 22 | | | | | J | | | | | | | | | | | |
| | 27 | | | | | J | | | | | | | | | | | |
| | 33 | | | | | J | | | | | | | | | | | |
| | 39 | | | | | J | | | | | | | | | | | |
| | 47 | | | | | J | | | | | | | | | | | |
| | 56 | | | | | J | | | | | | | | | | | |
| | 68 | | | | | J | | | | | | | | | | | |
| | 82 | | | | | J | | | | | | | | | | | |
| | 100 | | | | | J | | | | | | | | | | | |
| | 120 | | | | | J | | | | | | | | | | | |
| | 150 | | | | | J | | | | | | | | | | | |
| | 180 | | | | | J | | | | | | | | | | | |
| | 220 | | | | | J | | | | | | | | | | | |
| | 270 | | | | | J | | | | | | | | | | | |
| | 330 | | | | | J | | | | | | | | | | | |
| | 390 | | | | | M | | | | | | | | | | | |
| | 470 | | | | | M | | | | | | | | | | | |
| | 560 | J | J | J | J | M | | | | | | | | | | | |
| | 680 | J | J | J | J | M | | | | | | | | | | | |
| | 820 | J | J | J | J | M | | | | | | | | | | | |
| | 1000 | J | J | J | J | M | K | K | K | K | M | M | M | M | M | M | P |
| | 1200 | J | J | J | M | M | K | K | K | K | M | M | M | M | M | M | P |
| | 1500 | J | J | J | M | M | K | K | K | K | M | M | M | M | M | M | P |
| | 1800 | J | J | J | M | | K | K | K | K | M | M | M | M | M | M | P |
| | 2200 | J | J | J | Q | | K | K | K | K | P | M | M | M | M | M | P |
| | 2700 | J | J | J | Q | | K | K | K | P | Q | M | M | M | M | M | P |
| | 3300 | J | J | J | | | K | K | K | P | Q | M | M | M | M | M | P |
| | 3900 | J | J | M | | | K | K | K | P | Q | M | M | M | M | M | P |
| | 4700 | J | J | M | | | K | K | K | P | Q | M | M | M | M | M | P |
| | 5600 | J | J | | | | K | K | M | P | X | M | M | M | M | M | P |
| | 6800 | J | J | | | | K | K | M | X | | M | M | M | M | M | P |
| | 8200 | J | J | | | | K | M | M | | | M | M | | M | M | P |
| Cap (µF) | 0.010 | J | J | | | | K | M | M | | | M | M | | M | M | P |
| | 0.012 | J | J | | | | K | M | | | | M | M | | M | M | P |
| | 0.015 | | | | | | M | M | | | | M | M | | M | M | Y |
| | 0.018 | | | | | | M | M | | | | P | M | | M | M | Y |
| | 0.022 | | | | | | M | M | | | | P | | | M | Y | Y |
| | 0.027 | | | | | | M | M | | | | P | | | P | Y | Y |
| | 0.033 | | | | | | M | M | | | | P | | | P | | |
| | 0.039 | | | | | | M | M | | | | P | | | P | | |
| | 0.047 | | | | | | M | M | | | | P | | | P | | |
| | 0.068 | | | | | | M | M | | | | | | | P | | |
| | 0.082 | | | | | | M | M | | | | | | | Q | | |
| | 0.1 | | | | | | | | | | | | | | Q | | |

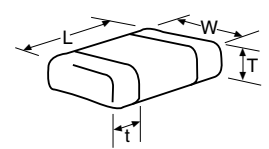

| Letter | A | C | E | G | J | K | M | N | P | Q | X | Y | Z |
|----------------|-----------------|-----------------|-----------------|-----------------|-----------------|-----------------|-----------------|-----------------|-----------------|-----------------|-----------------|-----------------|-----------------|
| Max. Thickness | 0.33 (0.013) | 0.56 (0.022) | 0.71 (0.028) | 0.90 (0.035) | 0.94 (0.037) | 1.02 (0.040) | 1.27 (0.050) | 1.40 (0.055) | 1.52 (0.060) | 1.78 (0.070) | 2.29 (0.090) | 2.54 (0.100) | 2.79 (0.110) |
| | PAPER | | | | | EMBOSS | | | | | | | |



MLCC Tin/Lead Termination “B”



Capacitance Range (X8R Dielectric)

| SIZE | | LD03 | | LD05 | | LD06 | |
|------|------------|------|-----|------|-----|------|-----|
| | WVDC | 25V | 50V | 25V | 50V | 25V | 50V |
| 271 | Cap 270 | G | G | | | | |
| 331 | (pF) 330 | G | G | J | J | | |
| 471 | 470 | G | G | J | J | | |
| 681 | 680 | G | G | J | J | | |
| 102 | 1000 | G | G | J | J | J | J |
| 152 | 1500 | G | G | J | J | J | J |
| 182 | 1800 | G | G | J | J | J | J |
| 222 | 2200 | G | G | J | J | J | J |
| 272 | 2700 | G | G | J | J | J | J |
| 332 | 3300 | G | G | J | J | J | J |
| 392 | 3900 | G | G | J | J | J | J |
| 472 | 4700 | G | G | J | J | J | J |
| 562 | 5600 | G | G | J | J | J | J |
| 682 | 6800 | G | G | J | J | J | J |
| 822 | 8200 | G | G | J | J | J | J |
| 103 | Cap 0.01 | G | G | J | J | J | J |
| 123 | (µF) 0.012 | G | G | J | J | J | J |
| 153 | 0.015 | G | G | J | J | J | J |
| 183 | 0.018 | G | G | J | J | J | J |
| 223 | 0.022 | G | G | J | J | J | J |
| 273 | 0.027 | G | G | J | J | J | J |
| 333 | 0.033 | G | G | J | J | J | J |
| 393 | 0.039 | G | G | J | J | J | J |
| 473 | 0.047 | G | G | J | J | J | J |
| 563 | 0.056 | G | | N | N | M | M |
| 683 | 0.068 | G | | N | N | M | M |
| 823 | 0.082 | | | N | N | M | M |
| 104 | 0.1 | | | N | N | M | M |
| 124 | 0.12 | | | N | N | M | M |
| 154 | 0.15 | | | N | N | M | M |
| 184 | 0.18 | | | N | | M | M |
| 224 | 0.22 | | | N | | M | M |
| 274 | 0.27 | | | | | M | M |
| 334 | 0.33 | | | | | M | M |
| 394 | 0.39 | | | | | M | |
| 474 | 0.47 | | | | | M | |
| 684 | 0.68 | | | | | | |
| 824 | 0.82 | | | | | | |
| 105 | 1 | | | | | | |
| SIZE | WVDC | 25V | 50V | 25V | 50V | 25V | 50V |
| | | LD03 | | LD05 | | LD06 | |

| Letter | A | C | E | G | J | K | M | N | P | Q | X | Y | Z |
|----------------|-----------------|-----------------|-----------------|-----------------|-----------------|-----------------|-----------------|-----------------|-----------------|-----------------|-----------------|-----------------|-----------------|
| Max. Thickness | 0.33 (0.013) | 0.56 (0.022) | 0.71 (0.028) | 0.90 (0.035) | 0.94 (0.037) | 1.02 (0.040) | 1.27 (0.050) | 1.40 (0.055) | 1.52 (0.060) | 1.78 (0.070) | 2.29 (0.090) | 2.54 (0.100) | 2.79 (0.110) |
| | PAPER | | | | | EMBOSSED | | | | | | | |

MLCC Tin/Lead Termination “B”



Capacitance Range (X7R Dielectric)

PREFERRED SIZES ARE SHADED

| SIZE | LD02 | | | LD03 | | | | | | LD05 | | | | | | LD06 | | | | | | | | | |
|--------------|--------------------------------|----|----|--------------------------------|----|----|----|----|-----|--------------------------------|-----|----|----|----|----|--------------------------------|-----|-----|----|----|----|----|-----|-----|-----|
| Soldering | Reflow/Wave | | | Reflow/Wave | | | | | | Reflow/Wave | | | | | | Reflow/Wave | | | | | | | | | |
| Packaging | All Paper | | | All Paper | | | | | | Paper/Embossed | | | | | | Paper/Embossed | | | | | | | | | |
| (L) Length | 1.00 ± 0.10 (0.040 ± 0.004) | | | 1.60 ± 0.15 (0.063 ± 0.006) | | | | | | 2.01 ± 0.20 (0.079 ± 0.008) | | | | | | 3.20 ± 0.20 (0.126 ± 0.008) | | | | | | | | | |
| (W) Width | 0.50 ± 0.10 (0.020 ± 0.004) | | | 0.81 ± 0.15 (0.032 ± 0.006) | | | | | | 1.25 ± 0.20 (0.049 ± 0.008) | | | | | | 1.60 ± 0.20 (0.063 ± 0.008) | | | | | | | | | |
| (t) Terminal | 0.25 ± 0.15 (0.010 ± 0.006) | | | 0.35 ± 0.15 (0.014 ± 0.006) | | | | | | 0.50 ± 0.25 (0.020 ± 0.010) | | | | | | 0.50 ± 0.25 (0.020 ± 0.010) | | | | | | | | | |
| WVDC | 16 | 25 | 50 | 6.3 | 10 | 16 | 25 | 50 | 100 | 200 | 6.3 | 10 | 16 | 25 | 50 | 100 | 200 | 6.3 | 10 | 16 | 25 | 50 | 100 | 200 | 500 |
| Cap (pF) | | | | | | | | | | | | | | | | | | | | | | | | | |
| 100 | | | | | | | | | | | | | | | | | | | | | | | | | |
| 150 | | | | | | | | | | | | | | | | | | | | | | | | | |
| 220 | | | C | | | | | | | | | | | | | | | | | | | | | | |
| 330 | | | C | | | | | G | G | G | | J | J | J | J | J | J | | | | | | | | K |
| 470 | | | C | | | | | G | G | G | | J | J | J | J | J | J | | | | | | | | K |
| 680 | | | C | | | | | G | G | G | | J | J | J | J | J | J | | | | | | | | K |
| 1000 | | | C | | | | | G | G | G | | J | J | J | J | J | J | | | | | | | | K |
| 1500 | | | C | | | | | G | G | G | | J | J | J | J | J | J | | J | J | J | J | J | J | M |
| 2200 | | | C | | | | | G | G | G | | J | J | J | J | J | J | | J | J | J | J | J | J | M |
| 3300 | | C | C | | | | | G | G | G | | J | J | J | J | J | J | | J | J | J | J | J | J | M |
| 4700 | | C | C | | | | | G | G | G | | J | J | J | J | J | J | | J | J | J | J | J | J | M |
| 6800 | G | C | C | | | | | G | G | G | | J | J | J | J | J | J | | J | J | J | J | J | J | P |
| Cap (µF) | | | | | | | | | | | | | | | | | | | | | | | | | |
| 0.010 | C | | | | | | | G | G | G | | J | J | J | J | J | J | | J | J | J | J | J | J | P |
| 0.015 | C | | | | | | | G | G | G | | J | J | J | J | J | J | | J | J | J | J | J | J | M |
| 0.022 | C | | | | | | | G | G | G | | J | J | J | J | J | J | | J | J | J | J | J | J | M |
| 0.033 | | | | | | | | G | G | G | | J | J | J | J | N | N | | J | J | J | J | J | J | M |
| 0.047 | | | | | | | | G | G | G | | J | J | J | J | N | N | | J | J | J | J | J | J | M |
| 0.068 | | | | | | | | G | G | G | | J | J | J | J | N | N | | J | J | J | J | J | J | P |
| 0.10 | | C* | | | | | | G | G | G | | J | J | J | J | N | N | | J | J | J | J | J | M | P |
| 0.15 | | | | | | | | G | G | G | | J | J | J | J | N | N | | J | J | J | J | J | J | Q |
| 0.22 | | | | | | | | G | G | G | | J | J | J | J | N | N | | J | J | J | J | J | J | Q |
| 0.33 | | | | | | | | | | | | N | N | N | N | N | N | | J | J | M | P | Q | Q | |
| 0.47 | | | | | | | | J* | | | | N | N | N | N | N | N | | M | M | M | P | Q | Q | |
| 0.68 | | | | | | | | J* | | | | N | N | N | N | N | N | | M | M | Q | Q | Q | Q | |
| 1.0 | | | | | | | | J* | J* | | | N | N | N* | | | | | M | M | Q | Q | Q | Q | |
| 1.5 | | | | | | | | | | | | | | | | | | | P | Q | Q | Q | | | |
| 2.2 | | | | | | | | J* | | | | | | | | P* | | | Q | Q | Q | | | | |
| 3.3 | | | | | | | | | | | | | | | | | | | Q | Q | Q | | | | |
| 4.7 | | | | | | | | | | | | | | | | | | | Q* | Q* | Q* | | | | |
| 10 | | | | | | | | | | | | | | | | | | | Q* | Q* | Q* | | | | |
| 22 | | | | | | | | | | | | | | | | | | | Q* | | | | | | |
| 47 | | | | | | | | | | | | | | | | | | | | | | | | | |
| 100 | | | | | | | | | | | | | | | | | | | | | | | | | |
| WVDC | 16 | 25 | 50 | 6.3 | 10 | 16 | 25 | 50 | 100 | 200 | 6.3 | 10 | 16 | 25 | 50 | 100 | 200 | 6.3 | 10 | 16 | 25 | 50 | 100 | 200 | 500 |

| Letter | A | C | E | G | J | K | M | N | P | Q | X | Y | Z |
|----------------|-----------------|-----------------|-----------------|-----------------|-----------------|-----------------|-----------------|-----------------|-----------------|-----------------|-----------------|-----------------|-----------------|
| Max. Thickness | 0.33 (0.013) | 0.56 (0.022) | 0.71 (0.028) | 0.90 (0.035) | 0.94 (0.037) | 1.02 (0.040) | 1.27 (0.050) | 1.40 (0.055) | 1.52 (0.060) | 1.78 (0.070) | 2.29 (0.090) | 2.54 (0.100) | 2.79 (0.110) |
| | PAPER | | | | | EMBOSED | | | | | | | |

= Under Development

MLCC Tin/Lead Termination "B"



Capacitance Range (X7R Dielectric)

PREFERRED SIZES ARE SHADED

| SIZE | LD10 | | | | | | | | LD12 | | | | LD13 | | LD20 | | | | LD14 | |
|--------------|--------------------------------|----|----|----|-----|-----|-----|----|--------------------------------|-----|-----|----|--------------------------------|----|--------------------------------|-----|-----|----|--------------------------------|---|
| | Reflow Only | | | | | | | | Reflow Only | | | | Reflow Only | | Reflow Only | | | | Reflow Only | |
| Packaging | Paper/Embossed | | | | | | | | All Embossed | | | | All Embossed | | All Embossed | | | | All Embossed | |
| (L) Length | 3.20 ± 0.20 (0.126 ± 0.008) | | | | | | | | 4.50 ± 0.30 (0.177 ± 0.012) | | | | 4.50 ± 0.30 (0.177 ± 0.012) | | 5.70 ± 0.40 (0.225 ± 0.016) | | | | 5.72 ± 0.25 (0.225 ± 0.010) | |
| (W) Width | 2.50 ± 0.20 (0.098 ± 0.008) | | | | | | | | 3.20 ± 0.20 (0.126 ± 0.008) | | | | 6.40 ± 0.40 (0.252 ± 0.016) | | 5.00 ± 0.40 (0.197 ± 0.016) | | | | 6.35 ± 0.25 (0.250 ± 0.010) | |
| (t) Terminal | 0.50 ± 0.25 (0.020 ± 0.010) | | | | | | | | 0.61 ± 0.36 (0.024 ± 0.014) | | | | 0.61 ± 0.36 (0.024 ± 0.014) | | 0.64 ± 0.39 (0.025 ± 0.015) | | | | 0.64 ± 0.39 (0.025 ± 0.015) | |
| WVDC | 10 | 16 | 25 | 50 | 100 | 200 | 500 | 50 | 100 | 200 | 500 | 50 | 100 | 25 | 50 | 100 | 200 | 50 | 100 | |
| Cap (pF) | 100 | | | | | | | | | | | | | | | | | | | |
| | 150 | | | | | | | | | | | | | | | | | | | |
| | 220 | | | | | | | | | | | | | | | | | | | |
| | 330 | | | | | | | | | | | | | | | | | | | |
| | 470 | | | | | | | | | | | | | | | | | | | |
| | 680 | | | | | | | | | | | | | | | | | | | |
| | 1000 | J | J | J | J | J | J | M | | | | | | | | | | | | |
| | 1500 | J | J | J | J | J | J | M | | | | | | | | | | | | |
| | 2200 | J | J | J | J | J | J | M | | | | | | | | | | | | |
| | 3300 | J | J | J | J | J | J | M | | | | | | | | | | | | |
| | 4700 | J | J | J | J | J | J | M | | | | | | | | | | | | |
| | 6800 | J | J | J | J | J | J | M | | | | | | | | | | | | |
| Cap (µF) | 0.010 | J | J | J | J | J | J | M | K | K | K | K | M | M | | X | X | X | M | P |
| | 0.015 | J | J | J | J | J | J | P | K | K | K | P | M | M | | X | X | X | M | P |
| | 0.022 | J | J | J | J | J | J | Q | K | K | K | P | M | M | | X | X | X | M | P |
| | 0.033 | J | J | J | J | J | J | Q | K | K | K | X | M | M | | X | X | X | M | P |
| | 0.047 | J | J | J | J | J | J | | K | K | K | Z | M | M | | X | X | X | M | P |
| | 0.068 | J | J | J | J | J | M | | K | K | K | Z | M | M | | X | X | X | M | P |
| | 0.10 | J | J | J | J | J | M | | K | K | K | Z | M | M | | X | X | X | M | P |
| | 0.15 | J | J | J | J | M | Z | | K | K | P | | M | M | | X | X | X | M | P |
| | 0.22 | J | J | J | J | P | Z | | K | K | P | | M | M | | X | X | X | M | P |
| | 0.33 | J | J | J | J | Q | | | K | M | X | | M | M | | X | X | X | M | P |
| | 0.47 | M | M | M | M | Q | | | K | P | | | M | M | | X | X | X | M | P |
| | 0.68 | M | M | P | X | X | | | M | Q | | | M | P | | X | X | | M | P |
| | 1.0 | N | N | P | X | Z | | | M | X | | | M | P | | X | X | | M | P |
| | 1.5 | N | N | Z | Z | Z | | | Z | Z | | | M | | | X | X | | M | X |
| | 2.2 | X | X | Z | Z | Z | | | Z | Z | | | | | | X | X | | M | |
| | 3.3 | X | X | Z | Z | | | | Z | | | | | | | X | Z | | | |
| | 4.7 | X | X | Z | Z | | | | Z | | | | | | | X | Z | | | |
| | 10 | Z | Z | Z | | | | | | | | | | | | Z | | | | |
| | 22 | Z | Z | | | | | | | | | | | | | | | | | |
| | 47 | | | | | | | | | | | | | | | | | | | |
| | 100 | | | | | | | | | | | | | | | | | | | |
| WVDC | 10 | 16 | 25 | 50 | 100 | 200 | 500 | 50 | 100 | 200 | 500 | 50 | 100 | 25 | 50 | 100 | 200 | 50 | 100 | |

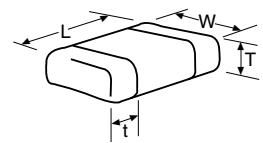

| Letter | A | C | E | G | J | K | M | N | P | Q | X | Y | Z |
|----------------|-----------------|-----------------|-----------------|-----------------|-----------------|-----------------|-----------------|-----------------|-----------------|-----------------|-----------------|-----------------|-----------------|
| Max. Thickness | 0.33 (0.013) | 0.56 (0.022) | 0.71 (0.028) | 0.90 (0.035) | 0.94 (0.037) | 1.02 (0.040) | 1.27 (0.050) | 1.40 (0.055) | 1.52 (0.060) | 1.78 (0.070) | 2.29 (0.090) | 2.54 (0.100) | 2.79 (0.110) |
| | PAPER | | | | | EMBOSS | | | | | | | |



MLCC Tin/Lead Termination "B"



Capacitance Range (X5R Dielectric)

PREFERRED SIZES ARE SHADED

| SIZE | LD02 | | | | | LD03 | | | | | LD05 | | | | | LD06 | | | | | LD10 | | | | | LD12 | | | | | | | | | |
|------------------|--------------------------------|-----|----|----|----|--------------------------------|---|-----|----|----|--------------------------------|----|----|-----|----|--------------------------------|----|----|----|-----|--------------------------------|----|----|----|----|------|-----|----|----|----|----|----|-----|----|----|
| | 4 | 6.3 | 10 | 16 | 25 | 50 | 4 | 6.3 | 10 | 16 | 25 | 35 | 50 | 6.3 | 10 | 16 | 25 | 35 | 50 | 6.3 | 10 | 16 | 25 | 35 | 50 | 4 | 6.3 | 10 | 16 | 25 | 35 | 50 | 6.3 | 10 | 25 |
| Soldering | Reflow/Wave | | | | | Reflow/Wave | | | | | Reflow/Wave | | | | | Reflow/Wave | | | | | Reflow/Wave | | | | | | | | | | | | | | |
| Packaging | All Paper | | | | | All Paper | | | | | Paper/Embossed | | | | | Paper/Embossed | | | | | Paper/Embossed | | | | | | | | | | | | | | |
| (L) Length | 1.00 ± 0.10 (0.040 ± 0.004) | | | | | 1.60 ± 0.15 (0.063 ± 0.006) | | | | | 2.01 ± 0.20 (0.079 ± 0.008) | | | | | 3.20 ± 0.20 (0.126 ± 0.008) | | | | | 3.20 ± 0.20 (0.126 ± 0.008) | | | | | | | | | | | | | | |
| (W) Width | 0.50 ± 0.10 (0.020 ± 0.004) | | | | | 0.81 ± 0.15 (0.032 ± 0.006) | | | | | 1.25 ± 0.20 (0.049 ± 0.008) | | | | | 1.60 ± 0.20 (0.063 ± 0.008) | | | | | 2.50 ± 0.20 (0.098 ± 0.008) | | | | | | | | | | | | | | |
| (t) Terminal | 0.25 ± 0.15 (0.010 ± 0.006) | | | | | 0.35 ± 0.15 (0.014 ± 0.006) | | | | | 0.50 ± 0.25 (0.020 ± 0.010) | | | | | 0.50 ± 0.25 (0.020 ± 0.010) | | | | | 0.50 ± 0.25 (0.020 ± 0.010) | | | | | | | | | | | | | | |
| Cap (pF) | C | | | | | | | | | | | | | | | | | | | | | | | | | | | | | | | | | | |
| Cap (µF) | C | | | | | G | | | | | N | | | | | Q | | | | | X | | | | | Z | | | | | | | | | |

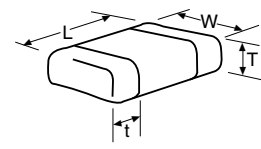

| Letter | A | C | E | G | J | K | M | N | P | Q | X | Y | Z |
|----------------|-----------------|-----------------|-----------------|-----------------|-----------------|-----------------|-----------------|-----------------|-----------------|-----------------|-----------------|-----------------|-----------------|
| Max. Thickness | 0.33 (0.013) | 0.56 (0.022) | 0.71 (0.028) | 0.90 (0.035) | 0.94 (0.037) | 1.02 (0.040) | 1.27 (0.050) | 1.40 (0.055) | 1.52 (0.060) | 1.78 (0.070) | 2.29 (0.090) | 2.54 (0.100) | 2.79 (0.110) |
| | PAPER | | | | | EMBOSS | | | | | | | |

- = Under Development
- = *Optional Specifications – Contact factory

NOTE: Contact factory for non-specified capacitance values

MLCC Low Profile



General Specifications

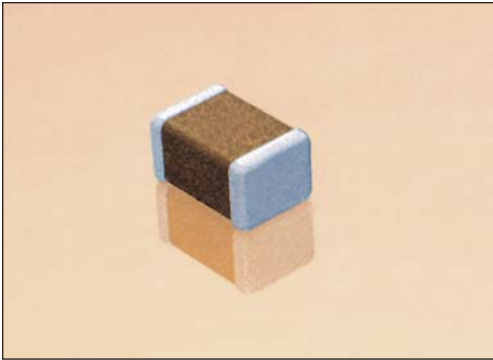

GENERAL DESCRIPTION

AVX introduces the LT series comprising a range of low profile products in our X5R and X7R dielectric. X5R is a Class II dielectric with temperature variation of capacitance within $\pm 15\%$ from -55°C to $+85^{\circ}\text{C}$. Offerings include 0201, 0402, 0603, 0805, 1206, and 1210 packages in compact, low profile designs. The LT series is ideal for decoupling and filtering applications where height clearance is limited.

AVX is also expanding the low profile products in our X7R dielectric. X7R is a Class II dielectric with temperature variation of capacitance within $\pm 15\%$ from -55°C to $+125^{\circ}\text{C}$. Please contact the factory for availability of any additional values not listed.

PART NUMBER (see page 2 for complete part number explanation)

| | | | | | | | | |
|--|---|--------------------|---------------------------------------|----------------------------------|-----------------------|-------------------------|---|---------------------|
| LT05 | Z | D | 475 | K | A | T | 2 | S |
| | | | | | | | | |
| Size | Voltage | Dielectric | Capacitance Code (In pF) | Capacitance Tolerance | Failure Rate | Terminations | Packaging | Special Code |
| LT01 - 0201 LT02 - 0402 LT03 - 0603 LT05 - 0805 LT06 - 1206 LT10 - 1210 | 4V = 4 6.3V = 6 10V = Z 16V = Y 25V = 3 | X5R = D X7R = C | 2 Sig. Digits + Number of Zeros | K = $\pm 10\%$ M = $\pm 20\%$ | A = Not Applicable | T = Plated Ni and Sn | 2 = 7" Reel 4 = 13" Reel 7 = Bulk Cass. 9 = Bulk | See table below |
| | | | | | | | Contact Factory For Multiples | |

NOTE: Contact factory for availability of tolerance options for specific part numbers.

| SIZE | | LT01 | LT02 | | | LT03 | | | | LT05 | | | | LT06 | | | LT10 | | |
|--------------------------|-----|------|------|-----|----|------|-----|-----|----|------|-----|----|----|------|----|----|------|----|----|
| WVDC | | 4 | 4 | 6.3 | 10 | 16 | 4 | 6.3 | 16 | 25 | 6.3 | 10 | 16 | 25 | 10 | 16 | 25 | 16 | 25 |
| Cap (μF) | 104 | 0.10 | Z | | Q | | S | | | | | | | | | | | | |
| | | 0.22 | | | | | | | | X | | | | | | | | | |
| | | 0.47 | | | | | | | | X | | | | | | | | X | |
| 105 | 1.0 | | C | | S | | | | S | X | | | X | X | | | | | |
| | 1.5 | | | | | | | | | | | | X | | | | | | |
| | 2.2 | | S | | | | | | S | X | | | X | | | | | | |
| | 4.7 | | | | | | S | X | | | | S | X | | | W | W | W | |
| 106 | 10 | | | | | | X/W | | | | X | X | | | W | W | W | | |
| | 22 | | | | | | | | | | | | | | W | | W | | |
| | 47 | | | | | | | | | | | | | | | | | | |
| WVDC | | 4 | 4 | 6.3 | 10 | 16 | 4 | 6.3 | 16 | 25 | 6.3 | 10 | 16 | 25 | 10 | 16 | 25 | 16 | 25 |
| SIZE | | LT01 | LT02 | | | LT03 | | | | LT05 | | | | LT06 | | | LT10 | | |

 = X7R

| Letter | J | Z | Q | C | S | X | W |
|----------------|-----------------|-----------------|-----------------|-----------------|-----------------|-----------------|-----------------|
| Max. Thickness | 0.15 (0.006) | 0.22 (0.009) | 0.25 (0.010) | 0.36 (0.014) | 0.56 (0.022) | 0.95 (0.038) | 1.02 (0.040) |
| | PAPER | | | | | | EMBOSSED |



UltraThin Ceramic Capacitors

UT023D103MAT2C

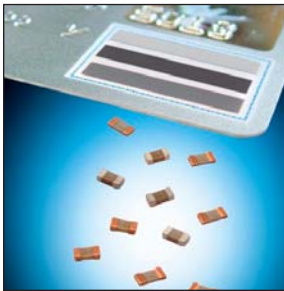

The Ultrathin (UT) series of ceramic capacitors is a new product offering from AVX. The UT series was designed to meet the stringent thickness requirements of our customers. AVX developed a new termination process (FCT - Fine Copper Termination) that provides unbeatable flatness and repeatability. The series includes products < 0.35mm in height and is targeted for applications such as Smart cards, Memory modules, High Density SIM cards, Mobile phones, MP3 players, and embedded solutions.

HOW TO ORDER

| | | | | | | | | | |
|----------------------------|--------------------------|-----------------------------|--|----------------------------------|------------------------------------|--|-------------------------------|---|--------------------------------|
| UT | 02 | 3 | D | 103 | M | A | T | 2 | C |
| Style Ultra Thin | Case Size 0402 | Rated Voltage 25V | Temperature Characteristic X5R | Coded Cap 0.01 μ F | Cap Tolerance $\pm 20\%$ | Termination Style Commercial | Termination 100% Sn | Packaging 7" Reel = 15,000 pcs 13" Reel = 50,000 pcs | Thickness 0.30mm max |

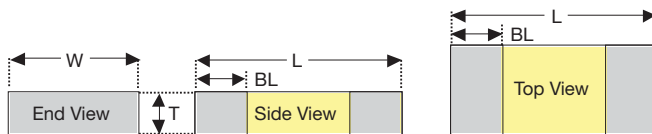

RECOMMENDED SOLDER PAD DIMENSIONS

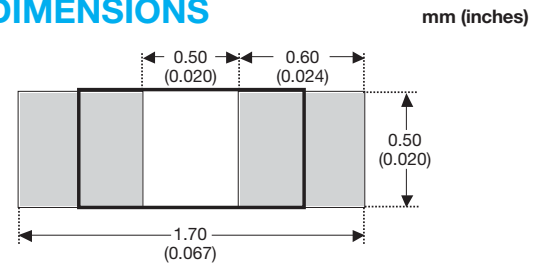

PART DIMENSIONS

| mm (inches) | | | |
|--|--|--|--|
| L | W | T | BL |
| 1.00 \pm 0.10 (0.039 \pm 0.004) | 0.50 \pm 0.10 (0.020 \pm 0.004) | 0.25 \pm 0.05 (0.010 \pm 0.002) | 0.25 \pm 0.10 (0.010 \pm 0.004) |

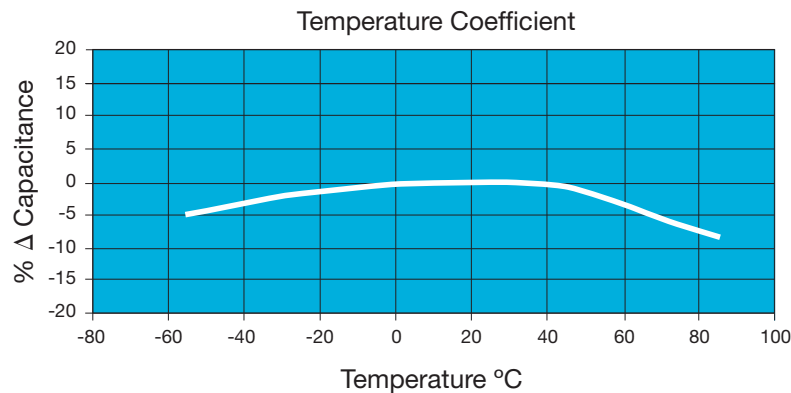

PERFORMANCE CHARACTERISTICS

| | |
|--|----------------|
| Capacitance Value | 0.01 μ F |
| Capacitance Tolerance | $\pm 20\%$ |
| Dissipation Factor Range | 3.0% |
| Operating Temperature | -55°C to +85°C |
| Temperature Coefficient | $\pm 15\%$ |
| Rated Voltage | 25V |
| Insulation Resistance at 25°C and Rated Voltage | 100,000 Mohms |
| Test Frequency | 1 Vrms @ 1 KHz |

Automotive

GENERAL DESCRIPTION

AVX Corporation has supported the Automotive Industry requirements for Multilayer Ceramic Capacitors consistently for more than 10 years. Products have been developed and tested specifically for automotive applications and all manufacturing facilities are QS9000 and VDA 6.4 approved.

As part of our sustained investment in capacity and state of the art technology, we are now transitioning from the established Pd/Ag electrode system to a Base Metal Electrode system (BME).

AVX is using AECQ200 as the qualification vehicle for this transition. A detailed qualification package is available on request and contains results on a range of part numbers including:

- X7R dielectric components containing BME electrode and copper terminations with a Ni/Sn plated overcoat.
- X7R dielectric components, BME electrode with epoxy finish for conductive glue mounting.
- X7R dielectric components BME electrode and soft terminations with a Ni/Sn plated overcoat.
- NP0 dielectric components containing Pd/Ag electrode and silver termination with a Ni/Sn plated overcoat.

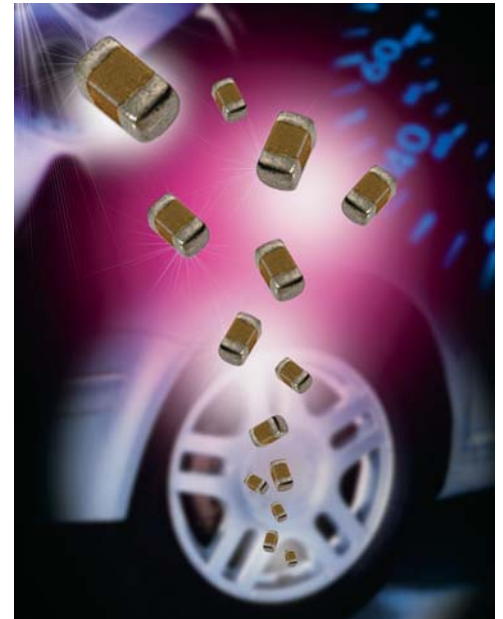

HOW TO ORDER

| 0805 | 5 | A | 104 | K | 4 | T | 2 | A |
|------|----------------------|------------|--|--|----------------|---|-----------------------------|------------------|
| Size | Voltage | Dielectric | Capacitance Code (In pF) | Capacitance Tolerance | Failure Rate | Terminations | Packaging | Special Code |
| 0402 | 10V = Z | NP0 = A | 2 Significant Digits + Number of Zeros | F = ±1% (≥10pF)* G = ±2% (≥10pF)* J = ±5% (≤1µF) K = ±10% M = ±20% | 4 = Automotive | T = Plated Ni and Sn Z = FLEXITERM®*** U = Conductive Epoxy** | 2 = 7" Reel 4 = 13" Reel | A = Std. Product |
| 0603 | 16V = Y | X7R = C | e.g. 10µF = 106 | | | | | |
| 0805 | 25V = 3 | X8R = F | | | | | | |
| 1206 | 50V = 5 | | | | | | | |
| 1210 | 100V = 1 | | | | | | | |
| 1812 | 200V = 2 500V = 7 | | | | | | | |

*NP0 only

Contact factory for availability of Tolerance Options for Specific Part Numbers.

NOTE: Contact factory for non-specified capacitance values.
0402 case size available in T termination only.

COMMERCIAL VS AUTOMOTIVE MLCC PROCESS COMPARISON

| | Commercial | Automotive |
|--|--|---|
| Administrative | Standard Part Numbers. No restriction on who purchases these parts. | Specific Automotive Part Number. Used to control supply of product to Automotive customers. |
| Design | Minimum ceramic thickness of 0.020" | Minimum Ceramic thickness of 0.029" (0.74mm) on all X7R product. |
| Dicing | Side & End Margins = 0.003" min | Side & End Margins = 0.004" min Cover Layers = 0.005" min |
| Lot Qualification (Destructive Physical Analysis - DPA) | As per EIA RS469 | Increased sample plan – stricter criteria. |
| Visual/Cosmetic Quality | Standard process and inspection | 100% inspection |
| Application Robustness | Standard sampling for accelerated wave solder on X7R dielectrics | Increased sampling for accelerated wave solder on X7R and NP0 followed by lot by lot reliability testing. |

All Tests have Accept/Reject Criteria 0/1

Automotive MLCC

NP0/X7R Dielectric



FLEXITERM® FEATURES

a) Bend Test
The capacitor is soldered to the PC Board as shown:

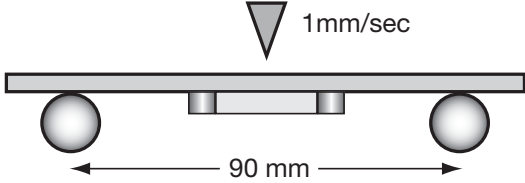

b) Temperature Cycle testing
FLEXITERM® has the ability to withstand at least 1000 cycles between -55°C and +125°C

Typical bend test results are shown below:

| Style | Conventional Term | Soft Term |
|-------|-------------------|-----------|
| 0603 | >2mm | >5 |
| 0805 | >2mm | >5 |
| 1206 | >2mm | >5 |

ELECTRODE AND TERMINATION OPTIONS

NP0 DIELECTRIC

**NP0 Ag/Pd Electrode
Nickel Barrier Termination
PCB Application**

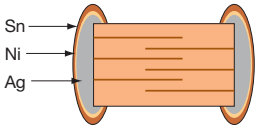

Figure 1 Termination Code T

X7R DIELECTRIC

**X7R Dielectric
PCB Application**

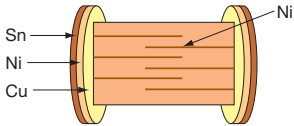

Figure 2 Termination Code T

**X7R Nickel Electrode
Soft Termination
PCB Application**

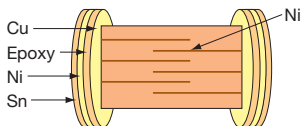

Figure 3 Termination Code Z

**Conductive Epoxy Termination
Hybrid Application**

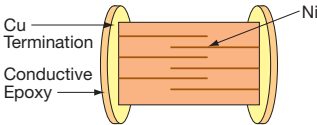

Figure 4 Termination Code U



Automotive MLCC - NP0



Capacitance Range

| | | 0603 | | | 0805 | | | 1206 | | | | | 1210 | | | | 1812 | |
|-----|------|------|-----|------|------|-----|------|------|-----|------|------|------|------|-----|------|------|------|------|
| | | 25V | 50V | 100V | 25V | 50V | 100V | 25V | 50V | 100V | 200V | 500V | 25V | 50V | 100V | 200V | 50V | 100V |
| 100 | 10pF | G | G | G | J | J | J | J | J | J | J | J | | | | | | |
| 120 | 12 | G | G | G | J | J | J | J | J | J | J | J | | | | | | |
| 150 | 15 | G | G | G | J | J | J | J | J | J | J | J | | | | | | |
| 180 | 18 | G | G | G | J | J | J | J | J | J | J | J | | | | | | |
| 220 | 22 | G | G | G | J | J | J | J | J | J | J | J | | | | | | |
| 270 | 27 | G | G | G | J | J | J | J | J | J | J | J | | | | | | |
| 330 | 33 | G | G | G | J | J | J | J | J | J | J | J | | | | | | |
| 390 | 39 | G | G | G | J | J | J | J | J | J | J | J | | | | | | |
| 470 | 47 | G | G | G | J | J | J | J | J | J | J | J | | | | | | |
| 510 | 51 | G | G | G | J | J | J | J | J | J | J | J | | | | | | |
| 560 | 56 | G | G | G | J | J | J | J | J | J | J | J | | | | | | |
| 680 | 68 | G | G | G | J | J | J | J | J | J | J | J | | | | | | |
| 820 | 82 | G | G | G | J | J | J | J | J | J | J | J | | | | | | |
| 101 | 100 | G | G | G | J | J | J | J | J | J | J | J | | | | | | |
| 121 | 120 | G | G | G | J | J | J | J | J | J | J | J | | | | | | |
| 151 | 150 | G | G | G | J | J | J | J | J | J | J | J | | | | | | |
| 181 | 180 | G | G | G | J | J | J | J | J | J | J | J | | | | | | |
| 221 | 220 | G | G | G | J | J | J | J | J | J | J | J | | | | | | |
| 271 | 270 | G | G | G | J | J | J | J | J | J | J | J | | | | | | |
| 331 | 330 | G | G | G | J | J | J | J | J | J | J | J | | | | | | |
| 391 | 390 | G | G | | J | J | J | J | J | J | J | J | | | | | | |
| 471 | 470 | G | G | | J | J | J | J | J | J | J | J | | | | | | |
| 561 | 560 | | | | J | J | J | J | J | J | J | J | | | | | | |
| 681 | 680 | | | | J | J | J | J | J | J | J | J | | | | | | |
| 821 | 820 | | | | J | J | J | J | J | J | J | J | | | | | | |
| 102 | 1000 | | | | J | J | J | J | J | J | J | J | J | J | J | J | | |
| 122 | 1200 | | | | | | | J | J | J | J | J | J | J | M | M | | |
| 152 | 1500 | | | | | | | J | M | M | M | M | J | J | M | M | | |
| 182 | 1800 | | | | | | | J | M | M | M | M | J | J | M | M | | |
| 222 | 2200 | | | | | | | J | M | M | M | M | J | J | M | M | | |
| 272 | 2700 | | | | | | | J | M | Q | | | J | J | M | | | |
| 332 | 3300 | | | | | | | J | M | Q | | | J | J | P | | K | K |
| 392 | 3900 | | | | | | | | | | | | J | J | P | | K | K |
| 472 | 4700 | | | | | | | | | | | | J | J | P | | K | K |
| 103 | 10nF | | | | | | | | | | | | | | | | | |
| | | 25V | 50V | 100V | 25V | 50V | 100V | 25V | 50V | 100V | 200V | 500V | 25V | 50V | 100V | 200V | 50V | 100V |
| | | 0603 | | | 0805 | | | 1206 | | | | | 1210 | | | | 1812 | |

| Letter | A | C | E | G | J | K | M | N | P | Q | X | Y | Z |
|----------------|-----------------|-----------------|-----------------|-----------------|-----------------|-----------------|-----------------|-----------------|-----------------|-----------------|-----------------|-----------------|-----------------|
| Max. Thickness | 0.33 (0.013) | 0.56 (0.022) | 0.71 (0.028) | 0.90 (0.035) | 0.94 (0.037) | 1.02 (0.040) | 1.27 (0.050) | 1.40 (0.055) | 1.52 (0.060) | 1.78 (0.070) | 2.29 (0.090) | 2.54 (0.100) | 2.79 (0.110) |
| | PAPER | | | | | EMBOSSED | | | | | | | |

 = Under Development

Automotive MLCC - X7R



Capacitance Range

| | | 0402 | | | 0603 | | | | 0805 | | | | 1206 | | | | | 1210 | | | | 1812 | | 2220 | | | | |
|-----|----------|------|-----|-----|------|-----|-----|------|------|-----|-----|-----|------|------|-----|-----|-----|------|------|------|-----|------|-----|------|-----|------|-----|-----|
| | | 16V | 25V | 50V | 16V | 25V | 50V | 100V | 200V | 16V | 25V | 50V | 100V | 200V | 16V | 25V | 50V | 100V | 200V | 500V | 16V | 25V | 50V | 100V | 50V | 100V | 25V | 50V |
| 221 | Cap .22 | | | | | | | | | | | | | | | | | | | | | | | | | | | |
| 271 | (nF) .27 | | | | | | | | | | | | | | | | | | | | | | | | | | | |
| 331 | .33 | | | | | | | | | | | | | | | | | | | | | | | | | | | |
| 391 | .39 | | | | | | | | | | | | | | | | | | | | | | | | | | | |
| 471 | .47 | | | | | | | | | | | | | | | | | | | | | | | | | | | |
| 561 | .56 | | | | | | | | | | | | | | | | | | | | | | | | | | | |
| 681 | .68 | | | | | | | | | | | | | | | | | | | | | | | | | | | |
| 821 | .82 | | | | | | | | | | | | | | | | | | | | | | | | | | | |
| 102 | 1 | | | | G | G | G | G | G | J | J | J | J | J | J | J | J | J | J | J | J | K | K | K | K | K | K | |
| 182 | 1.8 | | | | G | G | G | G | | J | J | J | J | J | J | J | J | J | J | J | J | K | K | K | K | K | K | |
| 222 | 2.2 | | | | G | G | G | G | | J | J | J | J | J | J | J | J | J | J | J | J | K | K | K | K | K | K | |
| 332 | 3.3 | | | | G | G | G | G | | J | J | J | J | J | J | J | J | J | J | J | J | K | K | K | K | K | K | |
| 472 | 4.7 | | | | G | G | G | G | | J | J | J | J | J | J | J | J | J | J | J | J | K | K | K | K | K | K | |
| 103 | 10 | | | | G | G | G | G | | J | J | J | J | J | J | J | J | J | J | J | J | K | K | K | K | K | K | |
| 123 | 12 | | | | G | G | G | | | J | J | J | M | | J | J | J | J | J | | | K | K | K | K | K | K | |
| 153 | 15 | | | | G | G | G | | | J | J | J | M | | J | J | J | J | J | | | K | K | K | K | K | K | |
| 183 | 18 | | | | G | G | G | | | J | J | J | M | | J | J | J | J | J | | | K | K | K | K | K | K | |
| 223 | 22 | | | | G | G | G | | | J | J | J | M | | J | J | J | J | J | | | K | K | K | K | K | K | |
| 273 | 27 | | | | G | G | G | | | J | J | J | M | | J | J | J | J | J | | | K | K | K | K | K | K | |
| 333 | 33 | | | | G | G | G | | | J | J | J | M | | J | J | J | J | J | | | K | K | K | K | K | K | |
| 473 | 47 | | | | G | G | G | | | J | J | J | M | | J | J | J | M | J | | | K | K | K | K | K | K | |
| 563 | 56 | | | | G | G | G | | | J | J | J | M | | J | J | J | M | J | | | K | K | K | M | K | K | |
| 683 | 68 | | | | G | G | G | | | J | J | J | M | | J | J | J | M | J | | | K | K | K | M | K | K | |
| 823 | 82 | | | | G | G | G | | | J | J | J | M | | J | J | J | M | J | | | K | K | K | M | K | K | |
| 104 | 100 | | | | G | G | G | | | J | J | M | M | | J | J | J | M | J | | | K | K | K | M | K | K | |
| 124 | 120 | | | | | | | | | J | J | M | | | J | J | M | M | | | | K | K | K | P | K | K | |
| 154 | 150 | | | | | | | | | M | N | M | | | J | J | M | M | | | | K | K | K | P | K | K | |
| 224 | 220 | | | | | | | | | M | N | M | | | J | M | M | Q | | | | M | M | M | P | M | M | |
| 334 | 330 | | | | | | | | | N | N | M | | | J | M | P | Q | | | | P | P | P | Q | X | X | |
| 474 | 470 | | | | | | | | | N | N | M | | | M | M | P | Q | | | | P | P | P | Q | X | X | |
| 684 | 680 | | | | | | | | | N | N | | | | M | Q | Q | Q | | | | P | P | Q | X | X | X | |
| 105 | Cap 1 | | | | | | | | | N | N | | | | M | Q | Q | Q | | | | P | Q | Q | X | X | X | |
| 155 | (µF) 1.5 | | | | | | | | | | | | | | Q | Q | | | | | | P | Q | Z | Z | X | X | |
| 225 | 2.2 | | | | | | | | | | | | | | Q | Q | | | | | | X | Z | Z | Z | Z | Z | |
| 335 | 3.3 | | | | | | | | | | | | | | | | | | | | | X | Z | Z | | Z | | |
| 475 | 4.7 | | | | | | | | | | | | | | | | | | | | | X | Z | Z | | Z | | |
| 106 | 10 | | | | | | | | | | | | | | | | | | | | | | | | | | | Z |
| 226 | 22 | | | | | | | | | | | | | | | | | | | | | | | | | | | Z |
| | | 16V | 25V | 50V | 16V | 25V | 50V | 100V | 200V | 16V | 25V | 50V | 100V | 200V | 16V | 25V | 50V | 100V | 200V | 500V | 16V | 25V | 50V | 100V | 50V | 100V | 25V | 50V |
| | | 0402 | | | 0603 | | | | 0805 | | | | 1206 | | | | | 1210 | | | | 1812 | | 2220 | | | | |

= Under Development

| Letter | A | C | E | G | J | K | M | N | P | Q | X | Y | Z |
|----------------|-----------------|-----------------|-----------------|-----------------|-----------------|-----------------|-----------------|-----------------|-----------------|-----------------|-----------------|-----------------|-----------------|
| Max. Thickness | 0.33 (0.013) | 0.56 (0.022) | 0.71 (0.028) | 0.90 (0.035) | 0.94 (0.037) | 1.02 (0.040) | 1.27 (0.050) | 1.40 (0.055) | 1.52 (0.060) | 1.78 (0.070) | 2.29 (0.090) | 2.54 (0.100) | 2.79 (0.110) |
| | PAPER | | | | | EMBOSSED | | | | | | | |

Automotive MLCC - X8R



Capacitance Range

| SIZE | | 0603 | | 0805 | | 1206 | |
|------|-------|------|-----|------|-----|------|-----|
| | WVDC | 25V | 50V | 25V | 50V | 25V | 50V |
| 271 | Cap | G | G | | | | |
| 331 | (pF) | G | G | J | J | | |
| 471 | 470 | G | G | J | J | | |
| 681 | 680 | G | G | J | J | | |
| 102 | 1000 | G | G | J | J | J | J |
| 152 | 1500 | G | G | J | J | J | J |
| 182 | 1800 | G | G | J | J | J | J |
| 222 | 2200 | G | G | J | J | J | J |
| 272 | 2700 | G | G | J | J | J | J |
| 332 | 3300 | G | G | J | J | J | J |
| 392 | 3900 | G | G | J | J | J | J |
| 472 | 4700 | G | G | J | J | J | J |
| 562 | 5600 | G | G | J | J | J | J |
| 682 | 6800 | G | G | J | J | J | J |
| 822 | 8200 | G | G | J | J | J | J |
| 103 | Cap | G | G | J | J | J | J |
| 123 | (µF) | G | G | J | J | J | J |
| 153 | 0.015 | G | G | J | J | J | J |
| 183 | 0.018 | G | G | J | J | J | J |
| 223 | 0.022 | G | G | J | J | J | J |
| 273 | 0.027 | G | G | J | J | J | J |
| 333 | 0.033 | G | G | J | J | J | J |
| 393 | 0.039 | G | G | J | J | J | J |
| 473 | 0.047 | G | G | J | J | J | J |
| 563 | 0.056 | G | | N | N | M | M |
| 683 | 0.068 | G | | N | N | M | M |
| 823 | 0.082 | | | N | N | M | M |
| 104 | 0.1 | | | N | N | M | M |
| 124 | 0.12 | | | N | N | M | M |
| 154 | 0.15 | | | N | N | M | M |
| 184 | 0.18 | | | N | | M | M |
| 224 | 0.22 | | | N | | M | M |
| 274 | 0.27 | | | | | M | M |
| 334 | 0.33 | | | | | M | M |
| 394 | 0.39 | | | | | M | |
| 474 | 0.47 | | | | | M | |
| 684 | 0.68 | | | | | | |
| 824 | 0.82 | | | | | | |
| 105 | 1 | | | | | | |
| | WVDC | 25V | 50V | 25V | 50V | 25V | 50V |
| SIZE | | 0603 | | 0805 | | 1206 | |

| Letter | A | C | E | G | J | K | M | N | P | Q | X | Y | Z |
|----------------|-----------------|-----------------|-----------------|-----------------|-----------------|-----------------|-----------------|-----------------|-----------------|-----------------|-----------------|-----------------|-----------------|
| Max. Thickness | 0.33 (0.013) | 0.56 (0.022) | 0.71 (0.028) | 0.90 (0.035) | 0.94 (0.037) | 1.02 (0.040) | 1.27 (0.050) | 1.40 (0.055) | 1.52 (0.060) | 1.78 (0.070) | 2.29 (0.090) | 2.54 (0.100) | 2.79 (0.110) |
| | PAPER | | | | | EMBOSSED | | | | | | | |

 = AEC-Q200 Qualified

APS Series

APS for COTS+ Applications

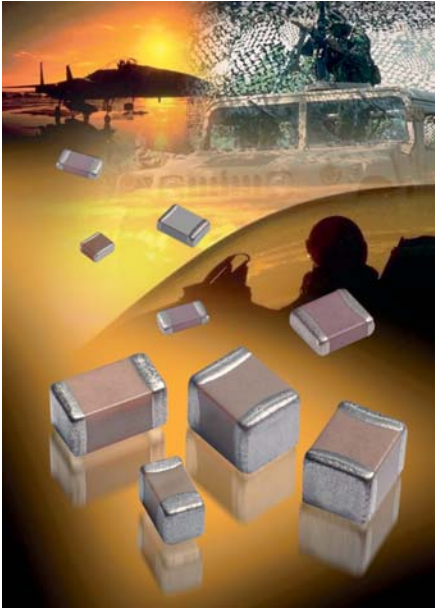

GENERAL DESCRIPTION

As part of our continuing support to high reliability customers, AVX has launched an Automotive Plus Series of parts (APS) qualified and manufactured in accordance with automotive AEC-Q200 standard. Each production batch is quality tested to an enhanced requirement and shipped with a certificate of conformance. On a quarterly basis a reliability package is issued to all APS customers.

A detailed qualification package is available on request and contains results on a range of part numbers including:

- X7R dielectric components containing BME electrode and copper terminations with a Ni/Sn plated overcoat.
- X7R dielectric components BME electrode and soft terminations with a Ni/Sn plated overcoat (FLEXITERM®).
- X7R for Hybrid applications.
- NP0 dielectric components containing Pd/Ag electrode and silver termination with a Ni/Sn plated overcoat.

We are also able to support customers who require an AEC-Q200 grade component finished with Tin/Lead.

HOW TO ORDER

| | | | | | | | | |
|-------------|----------------|-------------------|---------------------------------|------------------------------|---------------------|---------------------------------|------------------|---------------------|
| AP03 | 5 | A | 104 | K | Q | T | 2 | A |
| | | | | | | | | |
| Size | Voltage | Dielectric | Capacitance Code (In pF) | Capacitance Tolerance | Failure Rate | Terminations | Packaging | Special Code |
| AP03=0603 | 16V = Y | NP0 = A | 2 Significant Digits + | J = ±5% | Q = APS | T = Plated Ni and Sn** | 2 = 7" Reel | A = Std. Product |
| AP05=0805 | 25V = 3 | X7R = C | Number of Zeros | K = ±10% | | Z = FLEXITERM®** | 4 = 13" Reel | |
| AP06=1206 | 50V = 5 | | e.g. 10µF = 106 | M = ±20% | | U = Conductive Epoxy** | | |
| AP10=1210 | 100V = 1 | | | | | B = 5% min lead | | |
| AP12=1812 | 200V = 2 | | | | | X = FLEXITERM® with 5% min lead | | |
| | 500V = 7 | | | | | | | |
| | | | | | | Z, U, X for X7R only | | |
| | | | | | | **RoHS compliant | | |

NOTE: Contact factory for availability of Termination and Tolerance Options for Specific Part Numbers.

NP0 Automotive Plus Series / APS



Capacitance Range

| | | 0603 | | | 0805 | | | 1206 | | | | | 1210 | | | | 1812 | |
|-----|------|------|-----|------|------|-----|------|------|-----|------|------|------|------|-----|------|------|------|------|
| | | 25V | 50V | 100V | 25V | 50V | 100V | 25V | 50V | 100V | 200V | 500V | 25V | 50V | 100V | 200V | 50V | 100V |
| 100 | 10pF | G | G | G | J | J | J | J | J | J | J | J | | | | | | |
| 120 | 12 | G | G | G | J | J | J | J | J | J | J | J | | | | | | |
| 150 | 15 | G | G | G | J | J | J | J | J | J | J | J | | | | | | |
| 180 | 18 | G | G | G | J | J | J | J | J | J | J | J | | | | | | |
| 220 | 22 | G | G | G | J | J | J | J | J | J | J | J | | | | | | |
| 270 | 27 | G | G | G | J | J | J | J | J | J | J | J | | | | | | |
| 330 | 33 | G | G | G | J | J | J | J | J | J | J | J | | | | | | |
| 390 | 39 | G | G | G | J | J | J | J | J | J | J | J | | | | | | |
| 470 | 47 | G | G | G | J | J | J | J | J | J | J | J | | | | | | |
| 510 | 51 | G | G | G | J | J | J | J | J | J | J | J | | | | | | |
| 560 | 56 | G | G | G | J | J | J | J | J | J | J | J | | | | | | |
| 680 | 68 | G | G | G | J | J | J | J | J | J | J | J | | | | | | |
| 820 | 82 | G | G | G | J | J | J | J | J | J | J | J | | | | | | |
| 101 | 100 | G | G | G | J | J | J | J | J | J | J | J | | | | | | |
| 121 | 120 | G | G | G | J | J | J | J | J | J | J | J | | | | | | |
| 151 | 150 | G | G | G | J | J | J | J | J | J | J | J | | | | | | |
| 181 | 180 | G | G | G | J | J | J | J | J | J | J | J | | | | | | |
| 221 | 220 | G | G | G | J | J | J | J | J | J | J | J | | | | | | |
| 271 | 270 | G | G | G | J | J | J | J | J | J | J | J | | | | | | |
| 331 | 330 | G | G | G | J | J | J | J | J | J | J | J | | | | | | |
| 391 | 390 | G | G | | J | J | J | J | J | J | J | J | | | | | | |
| 471 | 470 | G | G | | J | J | J | J | J | J | J | J | | | | | | |
| 561 | 560 | | | | J | J | J | J | J | J | J | J | | | | | | |
| 681 | 680 | | | | J | J | J | J | J | J | J | J | | | | | | |
| 821 | 820 | | | | J | J | J | J | J | J | J | J | | | | | | |
| 102 | 1000 | | | | J | J | J | J | J | J | J | J | J | J | J | J | | |
| 122 | 1200 | | | | | | | J | J | J | | | J | J | M | M | | |
| 152 | 1500 | | | | | | | J | M | M | | | J | J | M | M | | |
| 182 | 1800 | | | | | | | J | M | M | | | J | J | M | M | | |
| 222 | 2200 | | | | | | | J | M | M | | | J | J | M | M | | |
| 272 | 2700 | | | | | | | J | M | Q | | | J | J | M | | | |
| 332 | 3300 | | | | | | | J | M | Q | | | J | J | P | | K | K |
| 392 | 3900 | | | | | | | | | | | | J | J | P | | K | K |
| 472 | 4700 | | | | | | | | | | | | J | J | P | | K | K |
| 103 | 10nF | | | | | | | | | | | | | | | | | |
| | | 0603 | | | 0805 | | | 1206 | | | | | 1210 | | | | 1812 | |
| | | 25V | 50V | 100V | 25V | 50V | 100V | 25V | 50V | 100V | 200V | 500V | 25V | 50V | 100V | 200V | 50V | 100V |

| Letter | A | C | E | G | J | K | M | N | P | Q | X | Y | Z |
|----------------|-----------------|-----------------|-----------------|-----------------|-----------------|-----------------|-----------------|-----------------|-----------------|-----------------|-----------------|-----------------|-----------------|
| Max. Thickness | 0.33 (0.013) | 0.56 (0.022) | 0.71 (0.028) | 0.90 (0.035) | 0.94 (0.037) | 1.02 (0.040) | 1.27 (0.050) | 1.40 (0.055) | 1.52 (0.060) | 1.78 (0.070) | 2.29 (0.090) | 2.54 (0.100) | 2.79 (0.110) |
| | PAPER | | | | | EMBOSSED | | | | | | | |

AEC-Q200 qualified
TS 16949, ISO 9001 certified



X7R Automotive Plus Series / APS



Capacitance Range

| | | 0603 | | | | | 0805 | | | | | 1206 | | | | | 1210 | | | | 1812 | | 2220 | | | |
|-----|------|------|-------------|-----|------|------|------|-------------|-----|------|------|------|-------------|-----|------|------|------|-------------|-----|-----|------|-------------|------|-------------|-----|-----|
| | | 16V | 25V | 50V | 100V | 200V | 16V | 25V | 50V | 100V | 200V | 16V | 25V | 50V | 100V | 200V | 500V | 16V | 25V | 50V | 100V | 50V | 100V | 25V | 50V | |
| 102 | Cap | 1 | G | G | G | G | J | J | J | J | J | J | J | J | J | J | J | K | K | K | K | K | K | | | |
| 182 | (nF) | 1.8 | G | G | G | G | J | J | J | J | J | J | J | J | J | J | J | K | K | K | K | K | K | | | |
| 222 | | 2.2 | G | G | G | G | J | J | J | J | J | J | J | J | J | J | J | K | K | K | K | K | K | | | |
| 332 | | 3.3 | G | G | G | G | J | J | J | J | J | J | J | J | J | J | J | K | K | K | K | K | K | | | |
| 472 | | 4.7 | G | G | G | G | J | J | J | J | J | J | J | J | J | J | J | K | K | K | K | K | K | | | |
| 103 | | 10 | G | G | G | G | J | J | J | J | J | J | J | J | J | J | J | K | K | K | K | K | K | | | |
| 123 | | 12 | G | G | G | | J | J | J | M | | J | J | J | J | J | | K | K | K | K | K | K | | | |
| 153 | | 15 | G | G | G | | J | J | J | M | | J | J | J | J | J | | K | K | K | K | K | K | | | |
| 183 | | 18 | G | G | G | | J | J | J | M | | J | J | J | J | J | | K | K | K | K | K | K | | | |
| 223 | | 22 | G | G | G | | J | J | J | M | | J | J | J | J | J | | K | K | K | K | K | K | | | |
| 273 | | 27 | G | G | G | | J | J | J | M | | J | J | J | J | J | | K | K | K | K | K | K | | | |
| 333 | | 33 | G | G | G | | J | J | J | M | | J | J | J | J | J | | K | K | K | K | K | K | | | |
| 473 | | 47 | G | G | G | | J | J | J | M | | J | J | J | M | J | | K | K | K | K | K | K | | | |
| 563 | | 56 | G | G | G | | J | J | J | M | | J | J | J | M | J | | K | K | K | M | K | K | | | |
| 683 | | 68 | G | G | G | | J | J | J | M | | J | J | J | M | J | | K | K | K | M | K | K | | | |
| 823 | | 82 | G | G | G | | J | J | J | M | | J | J | J | M | J | | K | K | K | M | K | K | | | |
| 104 | | 100 | G | G | G | | J | J | M | M | | J | J | J | M | J | | K | K | K | M | K | K | | | |
| 124 | | 120 | | | | | J | J | M | | | J | J | M | M | | | K | K | K | P | K | K | | | |
| 154 | | 150 | | | | | M | N | M | | | J | J | M | M | | | K | K | K | P | K | K | | | |
| 224 | | 220 | | | | | M | N | M | | | J | M | M | Q | | | M | M | M | P | M | M | | | |
| 334 | | 330 | | | | | N | N | M | | | J | M | P | Q | | | P | P | P | Q | X | X | | | |
| 474 | | 470 | | | | | N | N | M | | | M | M | P | Q | | | P | P | P | Q | X | X | | | |
| 684 | | 680 | | | | | N | N | | | | M | Q | Q | Q | | | P | P | Q | X | X | X | | | |
| 105 | Cap | 1 | | | | | N | N | | | | M | Q | Q | Q | | | P | Q | Q | X | X | X | | | |
| 155 | (µF) | 1.5 | | | | | | | | | | Q | Q | | | | | P | Q | Z | Z | X | X | | | |
| 225 | | 2.2 | | | | | | | | | | Q | Q | | | | | X | Z | Z | Z | Z | Z | | | |
| 335 | | 3.3 | | | | | | | | | | | | | | | | X | Z | Z | | Z | | | | |
| 475 | | 4.7 | | | | | | | | | | | | | | | | X | Z | Z | | Z | | | | |
| 106 | | 10 | | | | | | | | | | | | | | | | | | | | | | | Z | |
| 226 | | 22 | | | | | | | | | | | | | | | | | | | | | | | Z | |
| | | | 16V | 25V | 50V | 100V | 200V | 16V | 25V | 50V | 100V | 200V | 16V | 25V | 50V | 100V | 200V | 500V | 16V | 25V | 50V | 100V | 50V | 100V | 25V | 50V |
| | | | 0603 | | | | | 0805 | | | | | 1206 | | | | | 1210 | | | | 1812 | | 2220 | | |

 = Under Development

| Letter | A | C | E | G | J | K | M | N | P | Q | X | Y | Z |
|----------------|-----------------|-----------------|-----------------|-----------------|-----------------|-----------------|-----------------|-----------------|-----------------|-----------------|-----------------|-----------------|-----------------|
| Max. Thickness | 0.33 (0.013) | 0.56 (0.022) | 0.71 (0.028) | 0.90 (0.035) | 0.94 (0.037) | 1.02 (0.040) | 1.27 (0.050) | 1.40 (0.055) | 1.52 (0.060) | 1.78 (0.070) | 2.29 (0.090) | 2.54 (0.100) | 2.79 (0.110) |
| | PAPER | | | | | EMBOSSED | | | | | | | |

AEC-Q200 qualified
TS 16949, ISO 9001 certified



General Specifications

GENERAL DESCRIPTION

With increased requirements from the automotive industry for additional component robustness, AVX recognized the need to produce a MLCC with enhanced mechanical strength. It was noted that many components may be subject to severe flexing and vibration when used in various under the hood automotive and other harsh environment applications.

To satisfy the requirement for enhanced mechanical strength, AVX had to find a way of ensuring electrical integrity is maintained whilst external forces are being applied to the component. It was found that the structure of the termination needed to be flexible and after much research and development, AVX launched FLEXITERM®. FLEXITERM® is designed to enhance the mechanical flexure and temperature cycling performance of a standard ceramic capacitor with an X7R dielectric. **The industry standard for flexure is 2mm minimum. Using FLEXITERM®, AVX provides up to 5mm of flexure without internal cracks. Beyond 5mm, the capacitor will generally fail “open”.**

As well as for automotive applications FLEXITERM® will provide Design Engineers with a satisfactory solution when designing PCB's which may be subject to high levels of board flexure.

PRODUCT ADVANTAGES

- High mechanical performance able to withstand, 5mm bend test guaranteed.
- Increased temperature cycling performance, 3000 cycles and beyond.
- Flexible termination system.
- Reduction in circuit board flex failures.
- Base metal electrode system.
- Automotive or commercial grade products available.

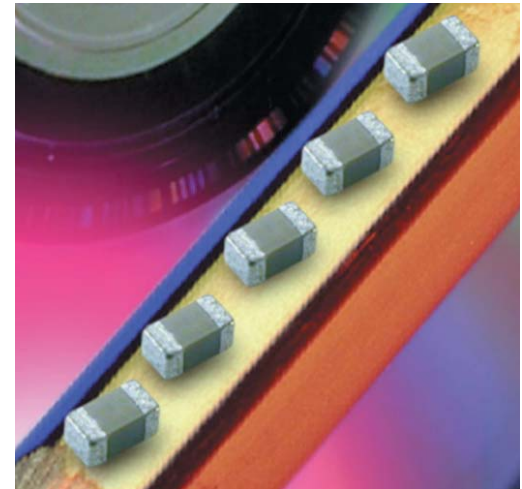

APPLICATIONS

High Flexure Stress Circuit Boards

- e.g. Depanelization: Components near edges of board.

Variable Temperature Applications

- Soft termination offers improved reliability performance in applications where there is temperature variation.
- e.g. All kind of engine sensors: Direct connection to battery rail.

Automotive Applications

- Improved reliability.
- Excellent mechanical performance and thermo mechanical performance.

HOW TO ORDER

0805

Style
0603
0805
1206
1210
1812
2220

5

Voltage
6 = 6.3V
Z = 10V
Y = 16V
3 = 25V
5 = 50V
1 = 100V
2 = 200V

C

Dielectric
C = X7R
F = X8R

104

Capacitance Code (In pF)
2 Sig Digits +
Number of Zeros
e.g., 104 = 100nF

K

Capacitance Tolerance
J = ±5%*
K = ±10%
M = ±20%

*≤1µF only

A

Failure Rate
A=Commercial
4 = Automotive

Z

Terminations
Z = FLEXITERM®
For FLEXITERM®
with Tin/Lead
termination see
AVX LD Series

2

Packaging
2 = 7" reel
4 = 13" reel

A

Special Code
A = Std. Product

NOTE: Contact factory for availability of Tolerance Options for Specific Part Numbers.



Specifications and Test Methods

PERFORMANCE TESTING

AEC-Q200 Qualification:

- Created by the Automotive Electronics Council
- Specification defining stress test qualification for passive components



Testing:

Key tests used to compare soft termination to AEC-Q200 qualification:

- Bend Test
- Temperature Cycle Test

BOARD BEND TEST RESULTS

AEC-Q200 Vrs AVX FLEXITERM® Bend Test

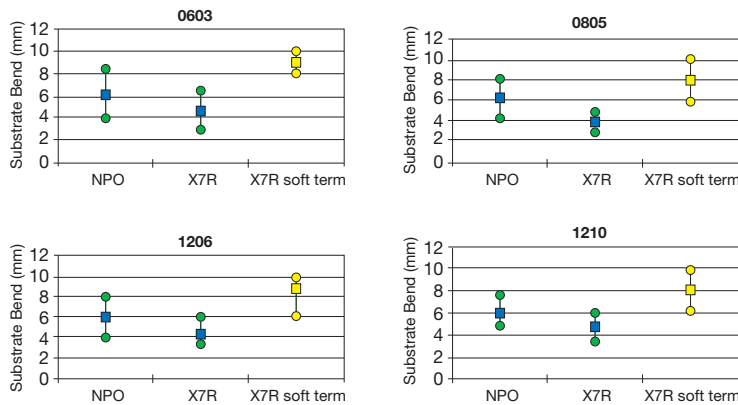

TABLE SUMMARY

Typical bend test results are shown below:

| Style | Conventional Termination | FLEXITERM® |
|-------|--------------------------|------------|
| 0603 | >2mm | >5mm |
| 0805 | >2mm | >5mm |
| 1206 | >2mm | >5mm |

TEMPERATURE CYCLE TEST PROCEDURE

Test Procedure as per AEC-Q200:

The test is conducted to determine the resistance of the component when it is exposed to extremes of alternating high and low temperatures.

- Sample lot size quantity 77 pieces
- TC chamber cycle from -55°C to +125°C for 1000 cycles
- Interim electrical measurements at 250, 500, 1000 cycles
- Measure parameter capacitance dissipation factor, insulation resistance

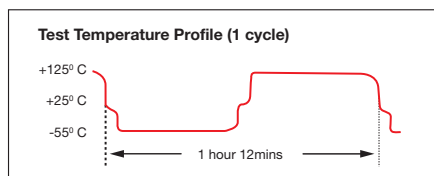

BOARD BEND TEST PROCEDURE

According to AEC-Q200

Test Procedure as per AEC-Q200:

Sample size: 20 components
Span: 90mm Minimum deflection spec: 2 mm

- Components soldered onto FR4 PCB (Figure 1)
- Board connected electrically to the test equipment (Figure 2)

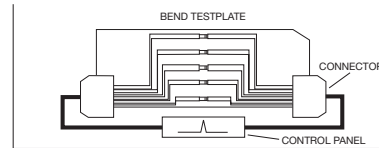

Fig 1 - PCB layout with electrical connections

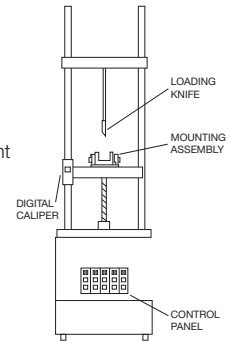
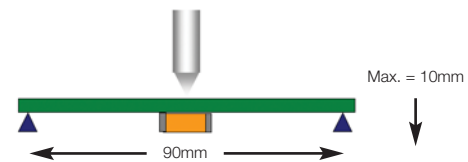

Fig 2 - Board Bend test equipment

AVX ENHANCED SOFT TERMINATION BEND TEST PROCEDURE

Bend Test

The capacitor is soldered to the printed circuit board as shown and is bent up to 10mm at 1 mm per second:



- The board is placed on 2 supports 90mm apart (capacitor side down)
- The row of capacitors is aligned with the load stressing knife



- The load is applied and the deflection where the part starts to crack is recorded (Note: Equipment detects the start of the crack using a highly sensitive current detection circuit)
- The maximum deflection capability is 10mm

BEYOND 1000 CYCLES: TEMPERATURE CYCLE TEST RESULTS

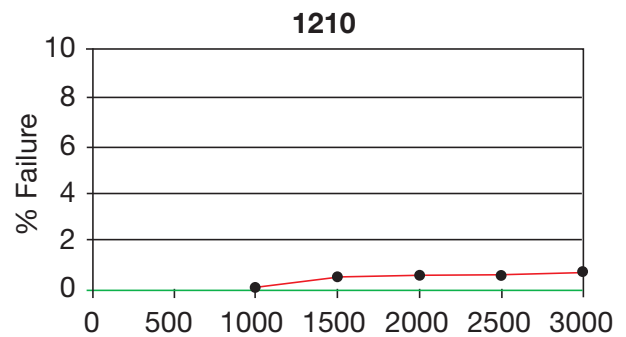
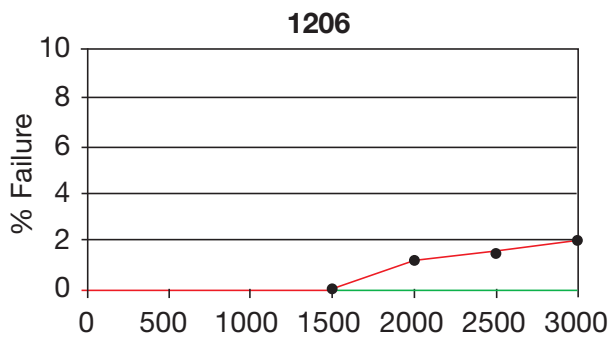
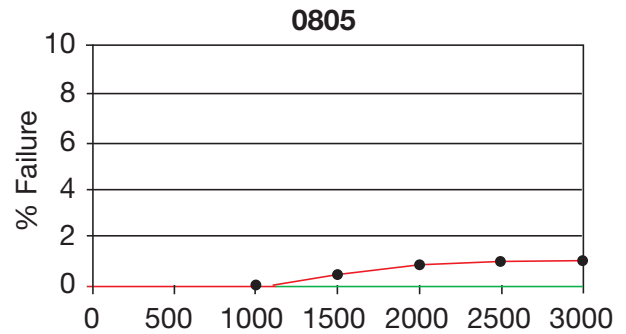
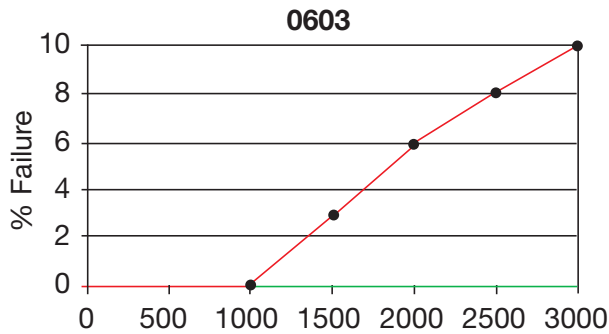

Soft Term - No Defects up to 3000 cycles

AEC-Q200 specification states 1000 cycles compared to AVX 3000 temperature cycles.

FLEXITERM® TEST SUMMARY

- Qualified to AEC-Q200 test/specification with the exception of using AVX 3000 temperature cycles (up to +150°C bend test guaranteed greater than 5mm).
- FLEXITERM® provides improved performance compared to standard termination systems.
- Board bend test improvement by a factor of 2 to 4 times.
- Temperature Cycling:
 - 0% Failure up to 3000 cycles
 - No ESR change up to 3000 cycles

WITHOUT SOFT TERMINATION

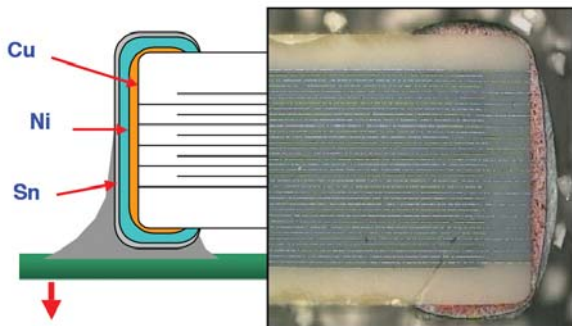

Major fear is of latent board flex failures.

WITH SOFT TERMINATION

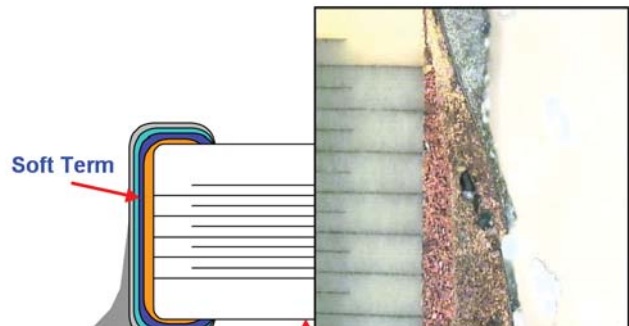

Far superior mechanical performance. Generally open failure mode beyond 5mm flexure.

MLCC with FLEXITERM®



X8R Dielectric Capacitance Range

| SIZE | | 0603 | | 0805 | | 1206 | |
|------|-------|------|-----|------|-----|------|-----|
| | WVDC | 25V | 50V | 25V | 50V | 25V | 50V |
| 271 | Cap | G | G | | | | |
| 331 | (pF) | G | G | J | J | | |
| 471 | 470 | G | G | J | J | | |
| 681 | 680 | G | G | J | J | | |
| 102 | 1000 | G | G | J | J | J | J |
| 152 | 1500 | G | G | J | J | J | J |
| 182 | 1800 | G | G | J | J | J | J |
| 222 | 2200 | G | G | J | J | J | J |
| 272 | 2700 | G | G | J | J | J | J |
| 332 | 3300 | G | G | J | J | J | J |
| 392 | 3900 | G | G | J | J | J | J |
| 472 | 4700 | G | G | J | J | J | J |
| 562 | 5600 | G | G | J | J | J | J |
| 682 | 6800 | G | G | J | J | J | J |
| 822 | 8200 | G | G | J | J | J | J |
| 103 | Cap | G | G | J | J | J | J |
| 123 | (µF) | G | G | J | J | J | J |
| 153 | 0.015 | G | G | J | J | J | J |
| 183 | 0.018 | G | G | J | J | J | J |
| 223 | 0.022 | G | G | J | J | J | J |
| 273 | 0.027 | G | G | J | J | J | J |
| 333 | 0.033 | G | G | J | J | J | J |
| 393 | 0.039 | G | G | J | J | J | J |
| 473 | 0.047 | G | G | J | J | J | J |
| 563 | 0.056 | G | | N | N | M | M |
| 683 | 0.068 | G | | N | N | M | M |
| 823 | 0.082 | | | N | N | M | M |
| 104 | 0.1 | | | N | N | M | M |
| 124 | 0.12 | | | N | N | M | M |
| 154 | 0.15 | | | N | N | M | M |
| 184 | 0.18 | | | N | | M | M |
| 224 | 0.22 | | | N | | M | M |
| 274 | 0.27 | | | | | M | M |
| 334 | 0.33 | | | | | M | M |
| 394 | 0.39 | | | | | M | |
| 474 | 0.47 | | | | | M | |
| 684 | 0.68 | | | | | | |
| 824 | 0.82 | | | | | | |
| 105 | 1 | | | | | | |
| | WVDC | 25V | 50V | 25V | 50V | 25V | 50V |
| SIZE | | 0603 | | 0805 | | 1206 | |

| Letter | A | C | E | G | J | K | M | N | P | Q | X | Y | Z |
|----------------|-----------------|-----------------|-----------------|-----------------|-----------------|-----------------|-----------------|-----------------|-----------------|-----------------|-----------------|-----------------|-----------------|
| Max. Thickness | 0.33 (0.013) | 0.56 (0.022) | 0.71 (0.028) | 0.90 (0.035) | 0.94 (0.037) | 1.02 (0.040) | 1.27 (0.050) | 1.40 (0.055) | 1.52 (0.060) | 1.78 (0.070) | 2.29 (0.090) | 2.54 (0.100) | 2.79 (0.110) |
| | PAPER | | | | | EMBOSSED | | | | | | | |

= AEC-Q200 Qualified

X7R Dielectric Capacitance Range

| | 0603 | | | | | 0805 | | | | | 1206 | | | | | 1210 | | | | 1812 | | | | 2220 | | | | | |
|-----|------|-----|-----|------|------|------|-----|-----|-----|------|------|-----|-----|-----|------|------|-----|-----|-----|------|-----|-----|-----|------|-----|-----|------|--|--|
| | 16V | 25V | 50V | 100V | 200V | 10V | 16V | 25V | 50V | 100V | 200V | 16V | 25V | 50V | 100V | 200V | 16V | 25V | 50V | 100V | 16V | 25V | 50V | 100V | 25V | 50V | 100V | | |
| 101 | | | | | | | | | | | | | | | | | | | | | | | | | | | | | |
| 121 | | | | | | | | | | | | | | | | | | | | | | | | | | | | | |
| 151 | | | | | | | | | | | | | | | | | | | | | | | | | | | | | |
| 181 | | | | | | | | | | | | | | | | | | | | | | | | | | | | | |
| 221 | | | | | | | | | | | | | | | | | | | | | | | | | | | | | |
| 271 | J | J | J | J | J | J | | | | | | | | | | | | | | | | | | | | | | | |
| 331 | J | J | J | J | J | J | J | J | J | J | J | | | | | | | | | | | | | | | | | | |
| 391 | J | J | J | J | J | J | J | J | J | J | J | | | | | | | | | | | | | | | | | | |
| 471 | J | J | J | J | J | J | J | J | J | J | J | | | | | | | | | | | | | | | | | | |
| 561 | J | J | J | J | J | J | J | J | J | J | J | | | | | | | | | | | | | | | | | | |
| 681 | J | J | J | J | J | J | J | J | J | J | J | | | | | | | | | | | | | | | | | | |
| 821 | J | J | J | J | J | J | J | J | J | J | J | | | | | | | | | | | | | | | | | | |
| 102 | J | J | J | J | J | J | J | J | J | J | J | J | J | J | J | | | | | | | | | | | | | | |
| 122 | J | J | J | J | | J | J | J | J | J | J | J | J | J | J | | | | | | | | | | | | | | |
| 152 | J | J | J | J | | J | J | J | J | J | J | J | J | J | J | | | | | | | | | | | | | | |
| 182 | J | J | J | J | | J | J | J | J | J | J | J | J | J | J | | | | | | | | | | | | | | |
| 222 | J | J | J | J | | J | J | J | J | J | J | J | J | J | J | | | | | | | | | | | | | | |
| 272 | J | J | J | J | | J | J | J | J | J | J | J | J | J | J | | | | | | | | | | | | | | |
| 332 | J | J | J | J | | J | J | J | J | J | J | J | J | J | J | | | | | | | | | | | | | | |
| 392 | J | J | J | J | | J | J | J | J | J | J | J | J | J | J | | | | | | | | | | | | | | |
| 472 | J | J | J | J | | J | J | J | J | J | J | J | J | J | J | | | | | | | | | | | | | | |
| 562 | J | J | J | J | | J | J | J | J | J | J | J | J | J | J | | | | | | | | | | | | | | |
| 682 | J | J | J | J | | J | J | J | J | J | J | J | J | J | J | | | | | | | | | | | | | | |
| 822 | J | J | J | J | | J | J | J | J | J | J | J | J | J | J | | | | | | | | | | | | | | |
| 103 | J | J | J | J | | J | J | J | J | J | J | J | J | J | J | | | | | | | | | | | | | | |
| 123 | J | J | J | | | J | J | J | J | M | | | | | | | | | | | | | | | | | | | |
| 153 | J | J | J | | | J | J | J | J | M | | | | | | | | | | | | | | | | | | | |
| 183 | J | J | J | | | J | J | J | J | M | | | | | | | | | | | | | | | | | | | |
| 223 | J | J | J | | | J | J | J | J | M | | | | | | | | | | | | | | | | | | | |
| 273 | J | J | J | | | J | J | J | J | M | | | | | | | | | | | | | | | | | | | |
| 333 | J | J | J | | | J | J | J | J | M | | | | | | | | | | | | | | | | | | | |
| 393 | J | J | J | | | J | J | J | J | M | | | | | | | | | | | | | | | | | | | |
| 473 | J | J | J | | | J | J | J | J | M | | | | | | | | | | | | | | | | | | | |
| 563 | J | J | J | | | J | J | J | J | N | | | | | | | | | | | | | | | | | | | |
| 683 | J | J | J | | | J | J | J | J | N | | | | | | | | | | | | | | | | | | | |
| 823 | J | J | J | | | J | J | J | J | N | | | | | | | | | | | | | | | | | | | |
| 104 | J | J | J | | | J | J | J | J | N | | | | | | | | | | | | | | | | | | | |
| 124 | | | | | | J | J | J | N | N | | | | | | | | | | | | | | | | | | | |
| 154 | | | | | | M | M | N | N | N | | | | | | | | | | | | | | | | | | | |
| 184 | | | | | | M | M | N | N | N | | | | | | | | | | | | | | | | | | | |
| 224 | | | | | | M | M | N | N | N | | | | | | | | | | | | | | | | | | | |
| 274 | | | | | | N | N | N | N | N | | | | | | | | | | | | | | | | | | | |
| 334 | | | | | | N | N | N | N | N | | | | | | | | | | | | | | | | | | | |
| 394 | | | | | | N | N | N | N | N | | | | | | | | | | | | | | | | | | | |
| 474 | | | | | | N | N | N | N | N | | | | | | | | | | | | | | | | | | | |
| 564 | | | | | | N | N | N | | | | | | | | | | | | | | | | | | | | | |
| 684 | | | | | | N | N | N | | | | | | | | | | | | | | | | | | | | | |
| 824 | | | | | | N | N | N | | | | | | | | | | | | | | | | | | | | | |
| 105 | | | | | | N | N | N | | | | | | | | | | | | | | | | | | | | | |
| 155 | | | | | | | | | | | | | | | | | | | | | | | | | | | | | |
| 185 | | | | | | | | | | | | | | | | | | | | | | | | | | | | | |
| 225 | | | | | | | | | | | | | | | | | | | | | | | | | | | | | |
| 335 | | | | | | | | | | | | | | | | | | | | | | | | | | | | | |
| 475 | | | | | | | | | | | | | | | | | | | | | | | | | | | | | |
| 106 | | | | | | | | | | | | | | | | | | | | | | | | | | | | | |
| 226 | | | | | | | | | | | | | | | | | | | | | | | | | | | | | |
| | 16V | 25V | 50V | 100V | 200V | 10V | 16V | 25V | 50V | 100V | 200V | 16V | 25V | 50V | 100V | 200V | 16V | 25V | 50V | 100V | 16V | 25V | 50V | 100V | 25V | 50V | 100V | | |
| | 0603 | | | | | 0805 | | | | | 1206 | | | | | 1210 | | | | 1812 | | | | 2220 | | | | | |

| Letter | A | C | E | G | J | K | M | N | P | Q | X | Y | Z |
|----------------|-----------------|-----------------|-----------------|-----------------|-----------------|-----------------|-----------------|-----------------|-----------------|-----------------|-----------------|-----------------|-----------------|
| Max. Thickness | 0.33 (0.013) | 0.56 (0.022) | 0.71 (0.028) | 0.90 (0.035) | 0.94 (0.037) | 1.02 (0.040) | 1.27 (0.050) | 1.40 (0.055) | 1.52 (0.060) | 1.78 (0.070) | 2.29 (0.090) | 2.54 (0.100) | 2.79 (0.110) |
| | PAPER | | | | | EMBOSSSED | | | | | | | |

FLEXISAFE MLC Chips



For Ultra Safety Critical Applications

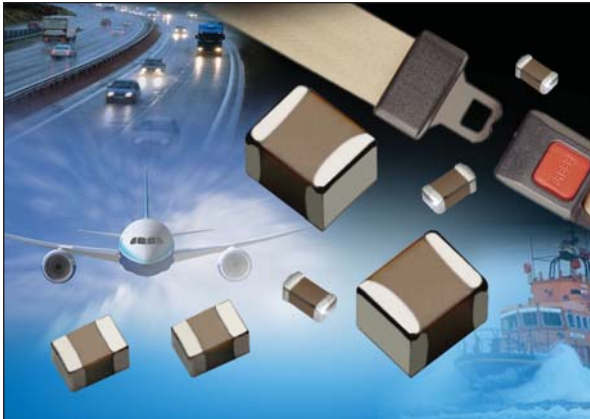

AVX have developed a range of components specifically for safety critical applications.

Utilizing the award-winning FLEXITERM™ layer in conjunction with the cascade design previously used for high voltage MLCCs, a range of ceramic capacitors is now available for customers who require components designed with an industry leading set of safety features.

The FLEXITERM™ layer protects the component from any damage to the ceramic resulting from mechanical stress during PCB assembly or use with end customers. Board flexure type mechanical damage accounts for the majority of MLCC failures. The addition of the cascade structure protects the component from low insulation resistance failure resulting from other common causes for failure; thermal stress damage, repetitive strike ESD damage and placement damage. With the inclusion of the cascade design structure to complement the FLEXITERM™ layer, the FLEXISAFE range of capacitors has unbeatable safety features.

HOW TO ORDER

| | | | | | | | | |
|--|---|-------------------|--|---------------------------------|---|---|-----------------------------|---------------------|
| FS03 | 5 | C | 104 | K | Q | Z | 2 | A |
| Size | Voltage | Dielectric | Capacitance Code (In pF) | Capacitance Tolerance | Failure Rate | Terminations | Packaging | Special Code |
| FS03 = 0603 FS05 = 0805 FS06 = 1206 FS10 = 1210 | 16V = Y 25V = 3 50V = 5 100V = 1 | X7R = C | 2 Sig. Digits + Number of Zeros e.g. 10µF = 106 | J = ±5% K = ±10% M = ±20% | A = Commercial 4 = Automotive Q = APS | Z = FLEXITERM™ X = FLEXITERM™ with 5% min lead | 2 = 7" Reel 4 = 13" Reel | A = Std. Product |

FLEXISAFE X7R RANGE

| Capacitance | | 0603 | | | | 0805 | | | 1206 | | | 1210 | | |
|-------------|-----|------|----|----|-----|------|----|----|------|----|----|------|----|----|
| Code | nF | 16 | 25 | 50 | 100 | 16 | 25 | 50 | 16 | 25 | 50 | 16 | 25 | 50 |
| 102 | 1 | | | | | | | | | | | | | |
| 182 | 1.8 | | | | | | | | | | | | | |
| 222 | 2.2 | | | | | | | | | | | | | |
| 332 | 3.3 | | | | | | | | | | | | | |
| 472 | 4.7 | | | | | | | | | | | | | |
| 103 | 10 | | | | | | | | | | | | | |
| 123 | 12 | | | | | | | | | | | | | |
| 153 | 15 | | | | | | | | | | | | | |
| 183 | 18 | | | | | | | | | | | | | |
| 223 | 22 | | | | | | | | | | | | | |
| 273 | 27 | | | | | | | | | | | | | |
| 333 | 33 | | | | | | | | | | | | | |
| 473 | 47 | | | | | | | | | | | | | |
| 563 | 56 | | | | | | | | | | | | | |
| 683 | 68 | | | | | | | | | | | | | |
| 823 | 82 | | | | | | | | | | | | | |
| 104 | 100 | | | | | | | | | | | | | |
| 124 | 120 | | | | | | | | | | | | | |
| 154 | 150 | | | | | | | | | | | | | |
| 224 | 220 | | | | | | | | | | | | | |
| 334 | 330 | | | | | | | | | | | | | |
| 474 | 470 | | | | | | | | | | | | | |

Qualified In Qualification

Capacitor Array (IPC)

BENEFITS OF USING CAPACITOR ARRAYS

AVX capacitor arrays offer designers the opportunity to lower placement costs, increase assembly line output through lower component count per board and to reduce real estate requirements.

Reduced Costs

Placement costs are greatly reduced by effectively placing one device instead of four or two. This results in increased throughput and translates into savings on machine time. Inventory levels are lowered and further savings are made on solder materials, etc.

Space Saving

Space savings can be quite dramatic when compared to the use of discrete chip capacitors. As an example, the 0508 4-element array offers a space reduction of >40% vs. 4 x 0402 discrete capacitors and of >70% vs. 4 x 0603 discrete capacitors. (This calculation is dependent on the spacing of the discrete components.)

Increased Throughput

Assuming that there are 220 passive components placed in a mobile phone:

A reduction in the passive count to 200 (by replacing discrete components with arrays) results in an increase in throughput of approximately 9%.

A reduction of 40 placements increases throughput by 18%.

For high volume users of cap arrays using the very latest placement equipment capable of placing 10 components per second, the increase in throughput can be very significant and can have the overall effect of reducing the number of placement machines required to mount components:

If 120 million 2-element arrays or 40 million 4-element arrays were placed in a year, the requirement for placement equipment would be reduced by one machine.

During a 20Hr operational day a machine places 720K components. Over a working year of 167 days the machine can place approximately 120 million. If 2-element arrays are mounted instead of discrete components, then the number of placements is reduced by a factor of two and in the scenario where 120 million 2-element arrays are placed there is a saving of one pick and place machine.

Smaller volume users can also benefit from replacing discrete components with arrays. The total number of placements is reduced thus creating spare capacity on placement machines. This in turn generates the opportunity to increase overall production output without further investment in new equipment.

W2A (0508) Capacitor Arrays

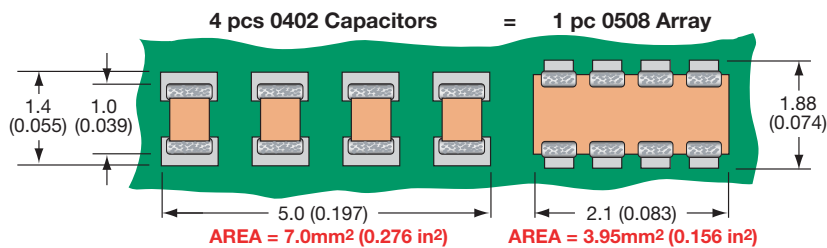

The 0508 4-element capacitor array gives a PCB space saving of over 40% vs four 0402 discretés and over 70% vs four 0603 discrete capacitors.

W3A (0612) Capacitor Arrays

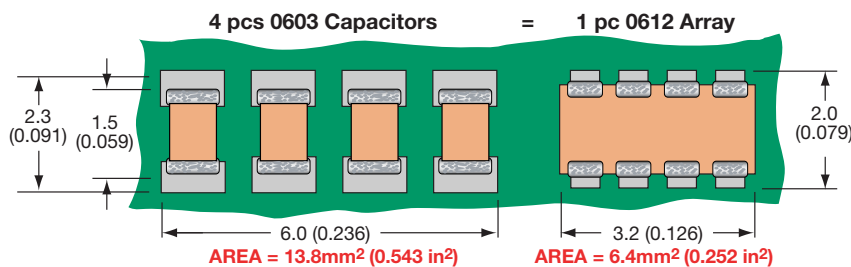

The 0612 4-element capacitor array gives a PCB space saving of over 50% vs four 0603 discretés and over 70% vs four 0805 discrete capacitors.

Capacitor Array



Capacitor Array (IPC)

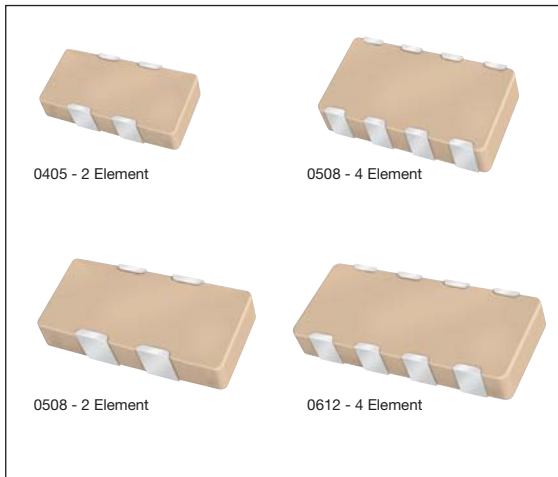

GENERAL DESCRIPTION

AVX is the market leader in the development and manufacture of capacitor arrays. The smallest array option available from AVX, the 0405 2-element device, has been an enormous success in the Telecommunications market. The array family of products also includes the 0612 4-element device as well as 0508 2-element and 4-element series, all of which have received widespread acceptance in the marketplace.

AVX capacitor arrays are available in X5R, X7R and NP0 (COG) ceramic dielectrics to cover a broad range of capacitance values. Voltage ratings from 6.3 Volts up to 100 Volts are offered. AVX also now offers a range of automotive capacitor arrays qualified to AEC-Q200 (see separate table).

Key markets for capacitor arrays are Mobile and Cordless Phones, Digital Set Top Boxes, Computer Motherboards and Peripherals as well as Automotive applications, RF Modems, Networking Products, etc.

AVX Capacitor Array - W2A41A*K
S21 Magnitude**



HOW TO ORDER

| | | | | | | | | | | |
|--------------------------------------|--|--------------|-----------------------|--|--|---|---|---|---|---|
| W | 2 | A | 4 | 3 | C | 103 | M | A | T | 2A |
| Style W = RoHS L = SnPb | Case Size 1 = 0405 2 = 0508 3 = 0612 5 = 0306 | Array | Number of Caps | Voltage 6 = 6V Z = 10V Y = 16V 3 = 25V 5 = 50V 1 = 100V | Dielectric A = NP0 C = X7R D = X5R | Capacitance Code 2 Sig Digits + Number of Zeros | Capacitance Tolerance J = ±5% K = ±10% M = ±20% | Failure Rate A = Commercial 4 = Automotive | Termination Code T = Plated Ni and Sn** Z = FLEXITERM®** B = 5% min lead X = FLEXITERM® with 5% min lead | Packaging & Quantity Code 2A = 7" Reel (4000) 4A = 13" Reel (10000) 2F = 7" Reel (1000) |

**RoHS compliant

NOTE: Contact factory for availability of Termination and Tolerance Options for Specific Part Numbers.





Capacitor Array

Capacitance Range – NP0/C0G

| SIZE | | 0405 | | | 0508 | | | | 0508 | | | | 0612 | | | |
|----------------|-------|-----------------|----|----|-----------------|----|----|-----|-----------------|----|----|-----|-----------------|----|----|-----|
| # Elements | | 2 | | | 2 | | | | 4 | | | | 4 | | | |
| Soldering | | Reflow Only | | | Reflow/Wave | | | | Reflow/Wave | | | | Reflow/Wave | | | |
| Packaging | | All Paper | | | All Paper | | | | Paper/Embossed | | | | Paper/Embossed | | | |
| Length | mm | 1.00 ± 0.15 | | | 1.30 ± 0.15 | | | | 1.30 ± 0.15 | | | | 1.60 ± 0.150 | | | |
| | (in.) | (0.039 ± 0.006) | | | (0.051 ± 0.006) | | | | (0.051 ± 0.006) | | | | (0.063 ± 0.006) | | | |
| Width | mm | 1.37 ± 0.15 | | | 2.10 ± 0.15 | | | | 2.10 ± 0.15 | | | | 3.20 ± 0.20 | | | |
| | (in.) | (0.054 ± 0.006) | | | (0.083 ± 0.006) | | | | (0.083 ± 0.006) | | | | (0.126 ± 0.008) | | | |
| Max. Thickness | mm | 0.66 | | | 0.94 | | | | 0.94 | | | | 1.35 | | | |
| | (in.) | (0.026) | | | (0.037) | | | | (0.037) | | | | (0.053) | | | |
| WVDC | | 16 | 25 | 50 | 16 | 25 | 50 | 100 | 16 | 25 | 50 | 100 | 16 | 25 | 50 | 100 |
| 1R0 | 1.0 | | | | | | | | | | | | | | | |
| 1R2 | 1.2 | | | | | | | | | | | | | | | |
| 1R5 | 1.5 | | | | | | | | | | | | | | | |
| 1R8 | 1.8 | | | | | | | | | | | | | | | |
| 2R2 | 2.2 | | | | | | | | | | | | | | | |
| 2R7 | 2.7 | | | | | | | | | | | | | | | |
| 3R3 | 3.3 | | | | | | | | | | | | | | | |
| 3R9 | 3.9 | | | | | | | | | | | | | | | |
| 4R7 | 4.7 | | | | | | | | | | | | | | | |
| 5R6 | 5.6 | | | | | | | | | | | | | | | |
| 6R8 | 6.8 | | | | | | | | | | | | | | | |
| 8R2 | 8.2 | | | | | | | | | | | | | | | |
| 100 | 10 | | | | | | | | | | | | | | | |
| 120 | 12 | | | | | | | | | | | | | | | |
| 150 | 15 | | | | | | | | | | | | | | | |
| 180 | 18 | | | | | | | | | | | | | | | |
| 220 | 22 | | | | | | | | | | | | | | | |
| 270 | 27 | | | | | | | | | | | | | | | |
| 330 | 33 | | | | | | | | | | | | | | | |
| 390 | 39 | | | | | | | | | | | | | | | |
| 470 | 47 | | | | | | | | | | | | | | | |
| 560 | 56 | | | | | | | | | | | | | | | |
| 680 | 68 | | | | | | | | | | | | | | | |
| 820 | 82 | | | | | | | | | | | | | | | |
| 101 | 100 | | | | | | | | | | | | | | | |
| 121 | 120 | | | | | | | | | | | | | | | |
| 151 | 150 | | | | | | | | | | | | | | | |
| 181 | 180 | | | | | | | | | | | | | | | |
| 221 | 220 | | | | | | | | | | | | | | | |
| 271 | 270 | | | | | | | | | | | | | | | |
| 331 | 330 | | | | | | | | | | | | | | | |
| 391 | 390 | | | | | | | | | | | | | | | |
| 471 | 470 | | | | | | | | | | | | | | | |
| 561 | 560 | | | | | | | | | | | | | | | |
| 681 | 680 | | | | | | | | | | | | | | | |
| 821 | 820 | | | | | | | | | | | | | | | |
| 102 | 1000 | | | | | | | | | | | | | | | |
| 122 | 1200 | | | | | | | | | | | | | | | |
| 152 | 1500 | | | | | | | | | | | | | | | |
| 182 | 1800 | | | | | | | | | | | | | | | |
| 222 | 2200 | | | | | | | | | | | | | | | |
| 272 | 2700 | | | | | | | | | | | | | | | |
| 332 | 3300 | | | | | | | | | | | | | | | |
| 392 | 3900 | | | | | | | | | | | | | | | |
| 472 | 4700 | | | | | | | | | | | | | | | |
| 562 | 5600 | | | | | | | | | | | | | | | |
| 682 | 6800 | | | | | | | | | | | | | | | |
| 822 | 8200 | | | | | | | | | | | | | | | |



Capacitor Array



Capacitance Range – X7R/X5R

| SIZE | 0306 | 0405 | 0508 | 0508 | 0612 | | | | | | | | | | | | | | | | | | | | | | | |
|----------------|-------------|-----------------|------|------|------|-------------|-----------------|----|----|----|-------------|-----------------|----|----|----|----------------|-----------------|----|----|----|----------------|-----------------|---|----|----|----|----|-----|
| # Elements | 4 | | | | | 2 | | | | | 2 | | | | | 4 | | | | | 4 | | | | | | | |
| Soldering | Reflow Only | | | | | Reflow Only | | | | | Reflow/Wave | | | | | Reflow/Wave | | | | | Reflow/Wave | | | | | | | |
| Packaging | All Paper | | | | | All Paper | | | | | All Paper | | | | | Paper/Embossed | | | | | Paper/Embossed | | | | | | | |
| Length | mm | 1.60 ± 0.15 | | | | mm | 1.00 ± 0.15 | | | | mm | 1.30 ± 0.15 | | | | mm | 1.30 ± 0.15 | | | | mm | 1.60 ± 0.150 | | | | | | |
| | (in.) | (0.063 ± 0.006) | | | | (in.) | (0.039 ± 0.006) | | | | (in.) | (0.051 ± 0.006) | | | | (in.) | (0.051 ± 0.006) | | | | (in.) | (0.063 ± 0.006) | | | | | | |
| Width | mm | 0.81 ± 0.15 | | | | mm | 1.37 ± 0.15 | | | | mm | 2.10 ± 0.15 | | | | mm | 2.10 ± 0.15 | | | | mm | 3.20 ± 0.20 | | | | | | |
| | (in.) | (0.032 ± 0.006) | | | | (in.) | (0.054 ± 0.006) | | | | (in.) | (0.083 ± 0.006) | | | | (in.) | (0.083 ± 0.006) | | | | (in.) | (0.126 ± 0.008) | | | | | | |
| Max. Thickness | mm | 0.50 | | | | mm | 0.66 | | | | mm | 0.94 | | | | mm | 0.94 | | | | mm | 1.35 | | | | | | |
| | (in.) | (0.020) | | | | (in.) | (0.026) | | | | (in.) | (0.037) | | | | (in.) | (0.037) | | | | (in.) | (0.053) | | | | | | |
| WVDC | | 6 | 10 | 16 | 25 | 6 | 10 | 16 | 25 | 50 | 6 | 10 | 16 | 25 | 50 | 100 | 6 | 10 | 16 | 25 | 50 | 100 | 6 | 10 | 16 | 25 | 50 | 100 |
| 101 | Cap | 100 | | | | | | | | | | | | | | | | | | | | | | | | | | |
| 121 | (µF) | 120 | | | | | | | | | | | | | | | | | | | | | | | | | | |
| 151 | | 150 | | | | | | | | | | | | | | | | | | | | | | | | | | |
| 181 | | 180 | | | | | | | | | | | | | | | | | | | | | | | | | | |
| 221 | | 220 | | | | | | | | | | | | | | | | | | | | | | | | | | |
| 271 | | 270 | | | | | | | | | | | | | | | | | | | | | | | | | | |
| 331 | | 330 | | | | | | | | | | | | | | | | | | | | | | | | | | |
| 391 | | 390 | | | | | | | | | | | | | | | | | | | | | | | | | | |
| 471 | | 470 | | | | | | | | | | | | | | | | | | | | | | | | | | |
| 561 | | 560 | | | | | | | | | | | | | | | | | | | | | | | | | | |
| 681 | | 680 | | | | | | | | | | | | | | | | | | | | | | | | | | |
| 821 | | 820 | | | | | | | | | | | | | | | | | | | | | | | | | | |
| 102 | | 1000 | | | | | | | | | | | | | | | | | | | | | | | | | | |
| 122 | | 1200 | | | | | | | | | | | | | | | | | | | | | | | | | | |
| 152 | | 1500 | | | | | | | | | | | | | | | | | | | | | | | | | | |
| 182 | | 1800 | | | | | | | | | | | | | | | | | | | | | | | | | | |
| 222 | | 2200 | | | | | | | | | | | | | | | | | | | | | | | | | | |
| 272 | | 2700 | | | | | | | | | | | | | | | | | | | | | | | | | | |
| 332 | | 3300 | | | | | | | | | | | | | | | | | | | | | | | | | | |
| 392 | | 3900 | | | | | | | | | | | | | | | | | | | | | | | | | | |
| 472 | | 4700 | | | | | | | | | | | | | | | | | | | | | | | | | | |
| 562 | | 5600 | | | | | | | | | | | | | | | | | | | | | | | | | | |
| 682 | | 6800 | | | | | | | | | | | | | | | | | | | | | | | | | | |
| 822 | | 8200 | | | | | | | | | | | | | | | | | | | | | | | | | | |
| 103 | Cap | 0.010 | | | | | | | | | | | | | | | | | | | | | | | | | | |
| 123 | (µF) | 0.012 | | | | | | | | | | | | | | | | | | | | | | | | | | |
| 153 | | 0.015 | | | | | | | | | | | | | | | | | | | | | | | | | | |
| 183 | | 0.018 | | | | | | | | | | | | | | | | | | | | | | | | | | |
| 223 | | 0.022 | | | | | | | | | | | | | | | | | | | | | | | | | | |
| 273 | | 0.027 | | | | | | | | | | | | | | | | | | | | | | | | | | |
| 333 | | 0.033 | | | | | | | | | | | | | | | | | | | | | | | | | | |
| 393 | | 0.039 | | | | | | | | | | | | | | | | | | | | | | | | | | |
| 473 | | 0.047 | | | | | | | | | | | | | | | | | | | | | | | | | | |
| 563 | | 0.056 | | | | | | | | | | | | | | | | | | | | | | | | | | |
| 683 | | 0.068 | | | | | | | | | | | | | | | | | | | | | | | | | | |
| 823 | | 0.082 | | | | | | | | | | | | | | | | | | | | | | | | | | |
| 104 | | 0.10 | | | | | | | | | | | | | | | | | | | | | | | | | | |
| 124 | | 0.12 | | | | | | | | | | | | | | | | | | | | | | | | | | |
| 154 | | 0.15 | | | | | | | | | | | | | | | | | | | | | | | | | | |
| 184 | | 0.18 | | | | | | | | | | | | | | | | | | | | | | | | | | |
| 224 | | 0.22 | | | | | | | | | | | | | | | | | | | | | | | | | | |
| 274 | | 0.27 | | | | | | | | | | | | | | | | | | | | | | | | | | |
| 334 | | 0.33 | | | | | | | | | | | | | | | | | | | | | | | | | | |
| 474 | | 0.47 | | | | | | | | | | | | | | | | | | | | | | | | | | |
| 564 | | 0.56 | | | | | | | | | | | | | | | | | | | | | | | | | | |
| 684 | | 0.68 | | | | | | | | | | | | | | | | | | | | | | | | | | |
| 824 | | 0.82 | | | | | | | | | | | | | | | | | | | | | | | | | | |
| 105 | | 1.0 | | | | | | | | | | | | | | | | | | | | | | | | | | |
| 125 | | 1.2 | | | | | | | | | | | | | | | | | | | | | | | | | | |
| 155 | | 1.5 | | | | | | | | | | | | | | | | | | | | | | | | | | |
| 185 | | 1.8 | | | | | | | | | | | | | | | | | | | | | | | | | | |
| 225 | | 2.2 | | | | | | | | | | | | | | | | | | | | | | | | | | |
| 335 | | 3.3 | | | | | | | | | | | | | | | | | | | | | | | | | | |
| 475 | | 4.7 | | | | | | | | | | | | | | | | | | | | | | | | | | |
| 106 | | 10 | | | | | | | | | | | | | | | | | | | | | | | | | | |
| 226 | | 22 | | | | | | | | | | | | | | | | | | | | | | | | | | |
| 476 | | 47 | | | | | | | | | | | | | | | | | | | | | | | | | | |
| 107 | | 100 | | | | | | | | | | | | | | | | | | | | | | | | | | |

- = Currently available X7R
- = Currently available X5R
- = Under development X7R, contact factory for advance samples
- = Under development X5R, contact factory for advance samples



Automotive Capacitor Array (IPC)

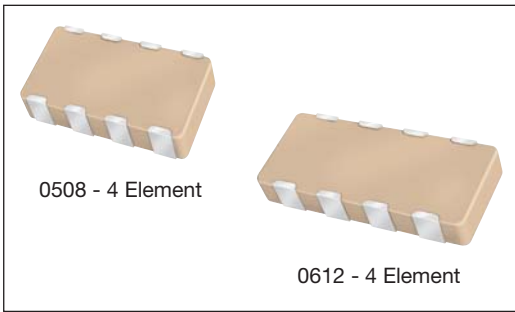

As the market leader in the development and manufacture of capacitor arrays AVX is pleased to offer a range of AEC-Q200 qualified arrays to compliment our product offering to the Automotive industry. Both the AVX 0612 and 0508 4-element capacitor array styles are qualified to the AEC-Q200 automotive specifications.

AEC-Q200 is the Automotive Industry qualification standard and a detailed qualification package is available on request.

All AVX automotive capacitor array production facilities are certified to ISO/TS 16949:2002.

HOW TO ORDER

| | | | | | | | | | | |
|----------------------|----------------------------------|--------------|-----------------------|--|-------------------------------|---|-----------------------------------|---------------------|--|---|
| W | 3 | A | 4 | Y | C | 104 | K | 4 | T | 2A |
| ↓ | ↓ | ↓ | ↓ | ↓ | ↓ | ↓ | ↓ | ↓ | ↓ | ↓ |
| Style | Case Size | Array | Number of Caps | Voltage | Dielectric | Capacitance Code (In pF) | Capacitance Tolerance | Failure Rate | Terminations | Packaging & Quantity Code |
| W = RoHS L = SnPb | 1 = 0405 2 = 0508 3 = 0612 | | | Z = 10V Y = 16V 3 = 25V 5 = 50V 1 = 100V | A = NP0 C = X7R F = X8R | Significant Digits + Number of Zeros e.g. 10µF=106 | *J = ±5% *K = ±10% M = ±20% | 4 = Automotive | T = Plated Ni and Sn** Z = FLEXITERM®** B = 5% min lead X = FLEXITERM® with 5% min lead | 2A = 7" Reel (4000) 4A = 13" Reel (10000) 2F = 7" Reel (1000) |

*Contact factory for availability by part number for K = ±10% and J = ±5% tolerance.

**RoHS compliant

| NP0/COG | | | | | | | | | | | | |
|-----------------|------------|------|------|----|----|-----|------|----|----|-----|--|--|
| SIZE | 0405 | 0508 | 0508 | | | | 0612 | | | | | |
| No. of Elements | 2 | 2 | 4 | | | | 4 | | | | | |
| WVDC | 50 | 50 | 16 | 25 | 50 | 100 | 16 | 25 | 50 | 100 | | |
| 1R0 | Cap 1.0 | | | | | | | | | | | |
| 1R2 | (pF) 1.2 | | | | | | | | | | | |
| 1R5 | 1.5 | | | | | | | | | | | |
| 1R8 | 1.8 | | | | | | | | | | | |
| 2R2 | 2.2 | | | | | | | | | | | |
| 2R7 | 2.7 | | | | | | | | | | | |
| 3R3 | 3.3 | | | | | | | | | | | |
| 3R9 | 3.9 | | | | | | | | | | | |
| 4R7 | 4.7 | | | | | | | | | | | |
| 5R6 | 5.6 | | | | | | | | | | | |
| 6R8 | 6.8 | | | | | | | | | | | |
| 8R2 | 8.2 | | | | | | | | | | | |
| 100 | 10 | | | | | | | | | | | |
| 120 | 12 | | | | | | | | | | | |
| 150 | 15 | | | | | | | | | | | |
| 180 | 18 | | | | | | | | | | | |
| 220 | 22 | | | | | | | | | | | |
| 270 | 27 | | | | | | | | | | | |
| 330 | 33 | | | | | | | | | | | |
| 390 | 39 | | | | | | | | | | | |
| 470 | 47 | | | | | | | | | | | |
| 560 | 56 | | | | | | | | | | | |
| 680 | 68 | | | | | | | | | | | |
| 820 | 82 | | | | | | | | | | | |
| 101 | 100 | | | | | | | | | | | |
| 121 | 120 | | | | | | | | | | | |
| 151 | 150 | | | | | | | | | | | |
| 181 | 180 | | | | | | | | | | | |
| 221 | 220 | | | | | | | | | | | |
| 271 | 270 | | | | | | | | | | | |
| 331 | 330 | | | | | | | | | | | |
| 391 | 390 | | | | | | | | | | | |
| 471 | 470 | | | | | | | | | | | |
| 561 | 560 | | | | | | | | | | | |
| 681 | 680 | | | | | | | | | | | |
| 821 | 820 | | | | | | | | | | | |
| 102 | 1000 | | | | | | | | | | | |
| 122 | 1200 | | | | | | | | | | | |
| 152 | 1500 | | | | | | | | | | | |
| 182 | 1800 | | | | | | | | | | | |
| 222 | 2200 | | | | | | | | | | | |
| 272 | 2700 | | | | | | | | | | | |
| 332 | 3300 | | | | | | | | | | | |
| 392 | 3900 | | | | | | | | | | | |
| 472 | 4700 | | | | | | | | | | | |
| 562 | 5600 | | | | | | | | | | | |
| 682 | 6800 | | | | | | | | | | | |
| 822 | 8200 | | | | | | | | | | | |
| 103 | Cap 0.010 | | | | | | | | | | | |
| 123 | (µF) 0.012 | | | | | | | | | | | |
| 153 | 0.015 | | | | | | | | | | | |
| 183 | 0.018 | | | | | | | | | | | |
| 223 | 0.022 | | | | | | | | | | | |
| 273 | 0.027 | | | | | | | | | | | |
| 333 | 0.033 | | | | | | | | | | | |
| 393 | 0.039 | | | | | | | | | | | |
| 473 | 0.047 | | | | | | | | | | | |
| 563 | 0.056 | | | | | | | | | | | |
| 683 | 0.068 | | | | | | | | | | | |
| 823 | 0.082 | | | | | | | | | | | |
| 104 | 0.10 | | | | | | | | | | | |
| 124 | 0.12 | | | | | | | | | | | |
| 154 | 0.15 | | | | | | | | | | | |
| 224 | 0.22 | | | | | | | | | | | |

| SIZE | X7R | | | | | | | | | | | | | | | X8R | |
|-----------------|------------|----|----|----|-----|------|----|----|-----|----|------|----|----|-----|---|-----|------|
| | 0508 | | | | | 0508 | | | | | 0612 | | | | | | 0405 |
| | 2 | | | | | 4 | | | | | 4 | | | | | | 2 |
| No. of Elements | 10 | 16 | 25 | 50 | 100 | 16 | 25 | 50 | 100 | 10 | 16 | 25 | 50 | 100 | 2 | | |
| 101 | Cap 100 | | | | | | | | | | | | | | | | |
| 121 | (pF) 120 | | | | | | | | | | | | | | | | |
| 151 | 150 | | | | | | | | | | | | | | | | |
| 181 | 180 | | | | | | | | | | | | | | | | |
| 221 | 220 | | | | | | | | | | | | | | | | |
| 271 | 270 | | | | | | | | | | | | | | | | |
| 331 | 330 | | | | | | | | | | | | | | | | |
| 391 | 390 | | | | | | | | | | | | | | | | |
| 471 | 470 | | | | | | | | | | | | | | | | |
| 561 | 560 | | | | | | | | | | | | | | | | |
| 681 | 680 | | | | | | | | | | | | | | | | |
| 821 | 820 | | | | | | | | | | | | | | | | |
| 102 | 1000 | | | | | | | | | | | | | | | | |
| 122 | 1200 | | | | | | | | | | | | | | | | |
| 152 | 1500 | | | | | | | | | | | | | | | | |
| 182 | 1800 | | | | | | | | | | | | | | | | |
| 222 | 2200 | | | | | | | | | | | | | | | | |
| 272 | 2700 | | | | | | | | | | | | | | | | |
| 332 | 3300 | | | | | | | | | | | | | | | | |
| 392 | 3900 | | | | | | | | | | | | | | | | |
| 472 | 4700 | | | | | | | | | | | | | | | | |
| 562 | 5600 | | | | | | | | | | | | | | | | |
| 682 | 6800 | | | | | | | | | | | | | | | | |
| 822 | 8200 | | | | | | | | | | | | | | | | |
| 103 | Cap 0.010 | | | | | | | | | | | | | | | | |
| 123 | (µF) 0.012 | | | | | | | | | | | | | | | | |
| 153 | 0.015 | | | | | | | | | | | | | | | | |
| 183 | 0.018 | | | | | | | | | | | | | | | | |
| 223 | 0.022 | | | | | | | | | | | | | | | | |
| 273 | 0.027 | | | | | | | | | | | | | | | | |
| 333 | 0.033 | | | | | | | | | | | | | | | | |
| 393 | 0.039 | | | | | | | | | | | | | | | | |
| 473 | 0.047 | | | | | | | | | | | | | | | | |
| 563 | 0.056 | | | | | | | | | | | | | | | | |
| 683 | 0.068 | | | | | | | | | | | | | | | | |
| 823 | 0.082 | | | | | | | | | | | | | | | | |
| 104 | 0.10 | | | | | | | | | | | | | | | | |
| 124 | 0.12 | | | | | | | | | | | | | | | | |
| 154 | 0.15 | | | | | | | | | | | | | | | | |
| 224 | 0.22 | | | | | | | | | | | | | | | | |

= X7R
 = X8R
 = Under development

= NP0/COG
 = Under development



Capacitor Array



Multi-Value Capacitor Array (IPC)

GENERAL DESCRIPTION

A recent addition to the array product range is the Multi-Value Capacitor Array. These devices combine two different capacitance values in standard 'Cap Array' packages and are available with a maximum ratio between the two capacitance values of 100:1. The multi-value array is currently available in the 0405 and 0508 2-element styles and also in the 0612 4-element style.

Whereas to date AVX capacitor arrays have been suited to applications where multiple capacitors of the same value are used, the multi-value array introduces a new flexibility to the range. The multi-value array can replace discrete capacitors of different values and can be used for broadband decoupling applications. The 0508 x 2 element multi-value array would be particularly recommended in this application. Another application is filtering the 900/1800 or 1900MHz noise in mobile phones. The 0405 2-element, low capacitance value NPO, (COG) device would be suited to this application, in view of the space saving requirements of mobile phone manufacturers.

ADVANTAGES OF THE MULTI-VALUE CAPACITOR ARRAYS

Enhanced Performance Due to Reduced Parasitic Inductance

When connected in parallel, not only do discrete capacitors of different values give the desired self-resonance, but an additional unwanted parallel resonance also results. This parallel resonance is induced between each capacitor's self-resonant frequencies and produces a peak in impedance response. For decoupling and bypassing applications this peak will result in a frequency band of reduced decoupling and in filtering applications reduced attenuation.

The multi-value capacitor array, combining capacitors in one unit, virtually eliminates the problematic parallel resonance, by minimizing parasitic inductance between the capacitors, thus enhancing the broadband decoupling/filtering performance of the part.

Reduced ESR

An advantage of connecting two capacitors in parallel is a significant reduction in ESR. However, as stated above, using discrete components brings with it the unwanted side effect of parallel resonance. The multi-value cap array is an excellent alternative as not only does it perform the same function as parallel capacitors but also it reduces the uncertainty of the frequency response.

HOW TO ORDER (Multi-Value Capacitor Array - IPC)

| | | | | | | | | | | |
|----------|----------------------------------|----------|----------------|--|-------------------------------|---|---|--------------|--|---|
| W | 2 | A | 2 | Y | C | 102M | 104M | A | T | 2A |
| Style | Case Size | Array | Number of Caps | Voltage | Dielectric | 1st Value | 2nd Value | Failure Rate | Terminations | Packaging & Quantity Code |
| | 1 = 0405 2 = 0508 3 = 0612 | | | Z = 10V Y = 16V 3 = 25V 5 = 50V 1 = 100V | A = NP0 C = X7R D = X5R | Capacitance Code (In pF) 2 Sig. Digits + No. of Zeros | Capacitance Tolerance K = ±10% M = ±20% | | T = Plated Ni and Sn** Z = FLEXITERM®** B = 5% min lead X = FLEXITERM® with 5% min lead | 2A = 7" Reel (4000) 4A = 13" Reel (10000) 2F = 7" Reel (1000) |

NOTE: Contact factory for availability of Termination and Tolerance Options for Specific Part Numbers.

**RoHS compliant

| | Cap (Min/Max) | |
|-----------------------|---------------|---------|
| | NP0 | X5R/X7R |
| 0612 4-element | 100/471 | 221/104 |
| 0508 2-element | 100/471 | 221/104 |
| 0405 2-element | 100/101 | 101/103 |

- Max. ratio between the two cap values is 1:100.
- The voltage of the higher capacitance value dictates the voltage of the multi-value part.
- Only combinations of values within a specific dielectric range are possible.

IMPEDANCE VS FREQUENCY

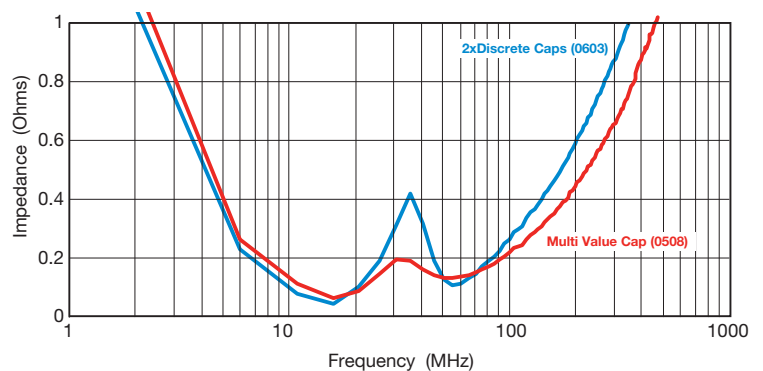

PART & PAD LAYOUT DIMENSIONS

millimeters (inches)

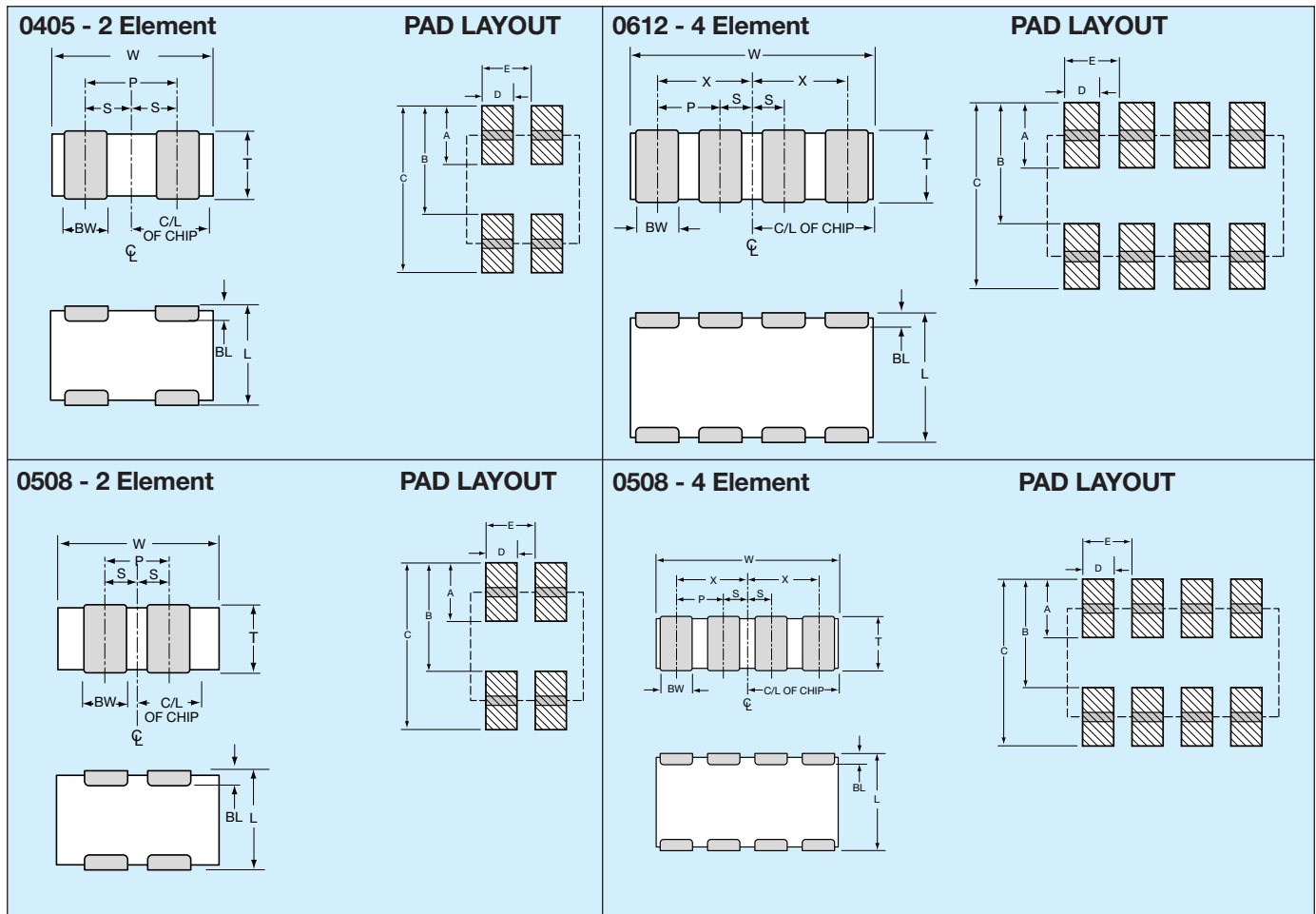

PART DIMENSIONS

0405 - 2 Element

| L | W | T | BW | BL | P | S |
|--------------------------------|--------------------------------|-------------------------|--------------------------------|--------------------------------|-------------------------|--------------------------------|
| 1.00 ± 0.15 (0.039 ± 0.006) | 1.37 ± 0.15 (0.054 ± 0.006) | 0.66 MAX (0.026 MAX) | 0.36 ± 0.10 (0.014 ± 0.004) | 0.20 ± 0.10 (0.008 ± 0.004) | 0.64 REF (0.025 REF) | 0.32 ± 0.10 (0.013 ± 0.004) |

0508 - 2 Element

| L | W | T | BW | BL | P | S |
|--------------------------------|--------------------------------|-------------------------|--------------------------------|--------------------------------|-------------------------|--------------------------------|
| 1.30 ± 0.15 (0.051 ± 0.006) | 2.10 ± 0.15 (0.083 ± 0.006) | 0.94 MAX (0.037 MAX) | 0.43 ± 0.10 (0.017 ± 0.004) | 0.33 ± 0.08 (0.013 ± 0.003) | 1.00 REF (0.039 REF) | 0.50 ± 0.10 (0.020 ± 0.004) |

0508 - 4 Element

| L | W | T | BW | BL | P | X | S |
|--------------------------------|--------------------------------|-------------------------|--------------------------------|--------------------------------|-------------------------|--------------------------------|--------------------------------|
| 1.30 ± 0.15 (0.051 ± 0.006) | 2.10 ± 0.15 (0.083 ± 0.006) | 0.94 MAX (0.037 MAX) | 0.25 ± 0.06 (0.010 ± 0.003) | 0.20 ± 0.08 (0.008 ± 0.003) | 0.50 REF (0.020 REF) | 0.75 ± 0.10 (0.030 ± 0.004) | 0.25 ± 0.10 (0.010 ± 0.004) |

0612 - 4 Element

| L | W | T | BW | BL | P | X | S |
|--------------------------------|--------------------------------|-------------------------|--------------------------------|--------------------------------|-------------------------|--------------------------------|--------------------------------|
| 1.60 ± 0.20 (0.063 ± 0.008) | 3.20 ± 0.20 (0.126 ± 0.008) | 1.35 MAX (0.053 MAX) | 0.41 ± 0.10 (0.016 ± 0.004) | 0.18 ± 0.08 (0.007 ± 0.003) | 0.76 REF (0.030 REF) | 1.14 ± 0.10 (0.045 ± 0.004) | 0.38 ± 0.10 (0.015 ± 0.004) |

PAD LAYOUT DIMENSIONS

0405 - 2 Element

| A | B | C | D | E |
|-----------------|-----------------|-----------------|-----------------|-----------------|
| 0.46 (0.018) | 0.74 (0.029) | 1.20 (0.047) | 0.30 (0.012) | 0.64 (0.025) |

0508 - 2 Element

| A | B | C | D | E |
|-----------------|-----------------|-----------------|-----------------|-----------------|
| 0.68 (0.027) | 1.32 (0.052) | 2.00 (0.079) | 0.46 (0.018) | 1.00 (0.039) |

0508 - 4 Element

| A | B | C | D | E |
|-----------------|-----------------|-----------------|-----------------|-----------------|
| 0.56 (0.022) | 1.32 (0.052) | 1.88 (0.074) | 0.30 (0.012) | 0.50 (0.020) |

0612 - 4 Element

| A | B | C | D | E |
|-----------------|-----------------|-----------------|-----------------|-----------------|
| 0.89 (0.035) | 1.65 (0.065) | 2.54 (0.100) | 0.46 (0.018) | 0.76 (0.030) |

Low Inductance Capacitors



Introduction

The signal integrity characteristics of a Power Delivery Network (PDN) are becoming critical aspects of board level and semiconductor package designs due to higher operating frequencies, larger power demands, and the ever shrinking lower and upper voltage limits around low operating voltages. These power system challenges are coming from mainstream designs with operating frequencies of 300MHz or greater, modest ICs with power demand of 15 watts or more, and operating voltages below 3 volts.

The classic PDN topology is comprised of a series of capacitor stages. Figure 1 is an example of this architecture with multiple capacitor stages.

An ideal capacitor can transfer all its stored energy to a load instantly. A real capacitor has parasitics that prevent instantaneous transfer of a capacitor's stored energy. The true nature of a capacitor can be modeled as an RLC equivalent circuit. For most simulation purposes, it is possible to model the characteristics of a real capacitor with one

capacitor, one resistor, and one inductor. The RLC values in this model are commonly referred to as equivalent series capacitance (ESC), equivalent series resistance (ESR), and equivalent series inductance (ESL).

The ESL of a capacitor determines the speed of energy transfer to a load. The lower the ESL of a capacitor, the faster that energy can be transferred to a load. Historically, there has been a tradeoff between energy storage (capacitance) and inductance (speed of energy delivery). Low ESL devices typically have low capacitance. Likewise, higher capacitance devices typically have higher ESLs. This tradeoff between ESL (speed of energy delivery) and capacitance (energy storage) drives the PDN design topology that places the fastest low ESL capacitors as close to the load as possible. Low Inductance MLCCs are found on semiconductor packages and on boards as close as possible to the load.

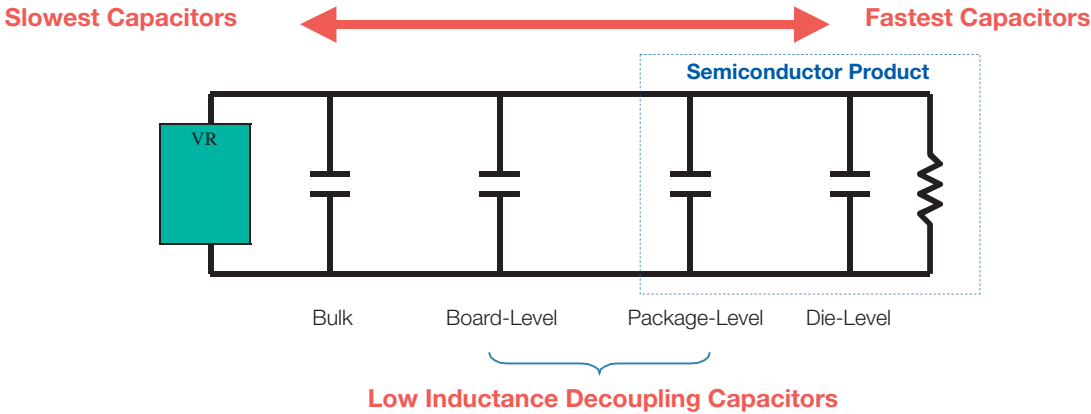

Figure 1 Classic Power Delivery Network (PDN) Architecture

LOW INDUCTANCE CHIP CAPACITORS

The key physical characteristic determining equivalent series inductance (ESL) of a capacitor is the size of the current loop it creates. The smaller the current loop, the lower the ESL. A standard surface mount MLCC is rectangular in shape with electrical terminations on its shorter sides. A Low Inductance Chip Capacitor (LICC) sometimes referred to as Reverse Geometry Capacitor (RGC) has its terminations on the longer side of its rectangular shape.

When the distance between terminations is reduced, the size of the current loop is reduced. Since the size of the current loop is the primary driver of inductance, an 0306 with a smaller current loop has significantly lower ESL than an 0603. The reduction in ESL varies by EIA size, however, ESL is typically reduced 60% or more with an LICC versus a standard MLCC.

INTERDIGITATED CAPACITORS

The size of a current loop has the greatest impact on the ESL characteristics of a surface mount capacitor. There is a secondary method for decreasing the ESL of a capacitor. This secondary method uses adjacent opposing current loops to reduce ESL. The InterDigitated Capacitor (IDC) utilizes both primary and secondary methods of reducing inductance. The IDC architecture shrinks the distance between terminations to minimize the current loop size, then further reduces inductance by creating adjacent opposing current loops.

An IDC is one single capacitor with an internal structure that has been optimized for low ESL. Similar to standard MLCC versus LICCs, the reduction in ESL varies by EIA case size. Typically, for the same EIA size, an IDC delivers an ESL that is at least 80% lower than an MLCC.

Introduction

LAND GRID ARRAY (LGA) CAPACITORS

Land Grid Array (LGA) capacitors are based on the first Low ESL MLCC technology created to specifically address the design needs of current day Power Delivery Networks (PDNs). This is the 3rd low inductance capacitor technology developed by AVX. LGA technology provides engineers with new options. The LGA internal structure and manufacturing technology eliminates the historic need for a device to be physically small to create small current loops to minimize inductance.

The first family of LGA products are 2 terminal devices. A 2 terminal 0306 LGA delivers ESL performance that is equal to or better than an 0306 8 terminal IDC. The 2 terminal 0805 LGA delivers ESL performance that approaches the 0508 8 terminal IDC. New designs that would have used 8 terminal IDCs are moving to 2 terminal LGAs because the layout is easier for a 2 terminal device and manufacturing yield is better for a 2 terminal LGA versus an 8 terminal IDC.

LGA technology is also used in a 4 terminal family of products that AVX is sampling and will formerly introduce in 2008. Beyond 2008, there are new multi-terminal LGA product families that will provide even more attractive options for PDN designers.

LOW INDUCTANCE CHIP ARRAYS (LICA®)

The LICA® product family is the result of a joint development effort between AVX and IBM to develop a high performance MLCC family of decoupling capacitors. LICA was introduced in the 1980s and remains the leading choice of designers in high performance semiconductor packages and high reliability board level decoupling applications.

LICA® products are used in 99.999% uptime semiconductor package applications on both ceramic and organic substrates. The C4 solder ball termination option is the perfect complement to flip-chip packaging technology. Mainframe class CPUs, ultimate performance multi-chip modules, and communications systems that must have the reliability of 5 9's use LICA®.

LICA® products with either Sn/Pb or Pb-free solder balls are used for decoupling in high reliability military and aerospace applications. These LICA® devices are used for decoupling of large pin count FPGAs, ASICs, CPUs, and other high power ICs with low operating voltages.

When high reliability decoupling applications require the very lowest ESL capacitors, LICA® products are the best option.

470 nF 0306 Impedance Comparison

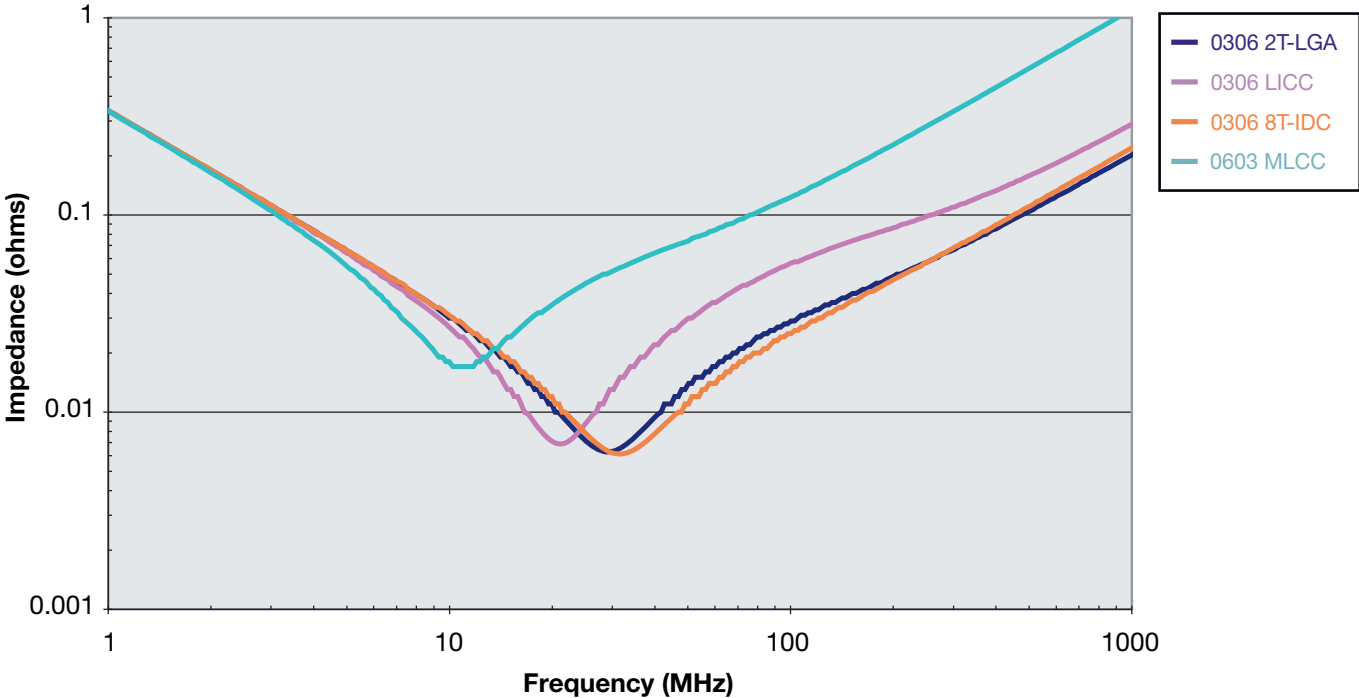

Figure 2 MLCC, LICC, IDC, and LGA technologies deliver different levels of equivalent series inductance (ESL).

Low Inductance Capacitors (RoHS)



0612/0508/0306/0204 LICC (Low Inductance Chip Capacitors)

GENERAL DESCRIPTION

The key physical characteristic determining equivalent series inductance (ESL) of a capacitor is the size of the current loop it creates. The smaller the current loop, the lower the ESL.

A standard surface mount MLCC is rectangular in shape with electrical terminations on its shorter sides. A Low Inductance Chip Capacitor (LICC) sometimes referred to as Reverse Geometry Capacitor (RGC) has its terminations on the longer sides of its rectangular shape. The image on the right shows the termination differences between an MLCC and an LICC.

When the distance between terminations is reduced, the size of the current loop is reduced. Since the size of the current loop is the primary driver of inductance, an 0306 with a smaller current loop has significantly lower ESL than an 0603. The reduction in ESL varies by EIA size, however, ESL is typically reduced 60% or more with an LICC versus a standard MLCC.

AVX LICC products are available with a lead-free finish of plated Nickel/Tin.

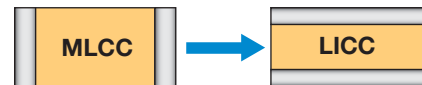
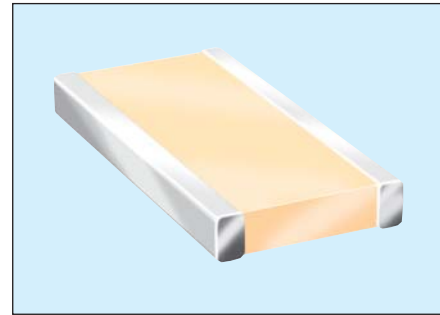

PERFORMANCE CHARACTERISTICS

| | |
|---|--|
| Capacitance Tolerances | K = $\pm 10\%$; M = $\pm 20\%$ |
| Operation Temperature Range | X7R = -55°C to $+125^{\circ}\text{C}$ X5R = -55°C to $+85^{\circ}\text{C}$ X7S = -55°C to $+125^{\circ}\text{C}$ |
| Temperature Coefficient | X7R, X5R = $\pm 15\%$; X7S = $\pm 22\%$ |
| Voltage Ratings | 4, 6.3, 10, 16, 25 VDC |
| Dissipation Factor | 4V, 6.3V = 6.5% max; 10V = 5.0% max; 16V = 3.5% max; 25V = 3.0% max |
| Insulation Resistance (@+25°C, RVDC) | 100,000M Ω min, or 1,000M Ω per μF min., whichever is less |

HOW TO ORDER

0612

Size
0204
0306
0508
0612

Z

Voltage
4 = 4V
6 = 6.3V
Z = 10V
Y = 16V
3 = 25V
5 = 50V

D

Dielectric
C = X7R
D = X5R
W = X6S
Z = X7S

105

Capacitance Code (In pF)
2 Sig. Digits +
Number of Zeros

M

Capacitance Tolerance
K = $\pm 10\%$
M = $\pm 20\%$

A

Failure Rate
A = N/A

T

Terminations
T = Plated Ni
and Sn

2

Packaging Available
2 = 7" Reel
4 = 13" Reel

A*

Thickness
Thickness
mm (in)
0.35 (0.014)
0.56 (0.022)
0.61 (0.024)
0.76 (0.030)
1.02 (0.040)
1.27 (0.050)

NOTE: Contact factory for availability of Termination and Tolerance Options for Specific Part Numbers.

TYPICAL IMPEDANCE CHARACTERISTICS

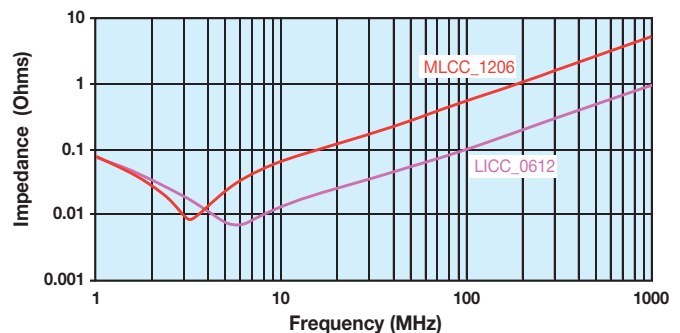
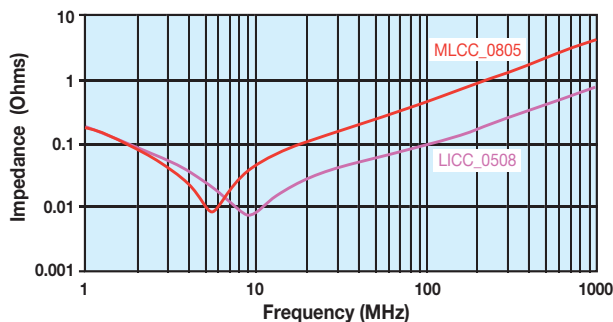

Low Inductance Capacitors (RoHS)



0612/0508/0306/0204 LICC (Low Inductance Chip Capacitors)

| SIZE | 0204 | | | | 0306 | | | | | 0508 | | | | | 0612 | | | | | | | | | | | | | | |
|-----------------|------|-----|----|----|------|-----|----|----|----|------|-----|----|----|----|--------------------------------|-----|----|----|----|--------------------------------|--|--|--|--|--------------------------------|--|--|--|--|
| Packaging | | | | | | | | | | | | | | | Embossed | | | | | Embossed | | | | | Embossed | | | | |
| Length mm (in.) | | | | | | | | | | | | | | | 0.81 ± 0.15 (0.032 ± 0.006) | | | | | 1.27 ± 0.25 (0.050 ± 0.010) | | | | | 1.60 ± 0.25 (0.063 ± 0.010) | | | | |
| Width mm (in.) | | | | | | | | | | | | | | | 1.60 ± 0.15 (0.063 ± 0.006) | | | | | 2.00 ± 0.25 (0.080 ± 0.010) | | | | | 3.20 ± 0.25 (0.126 ± 0.010) | | | | |
| WVDC | 4 | 6.3 | 10 | 16 | 4 | 6.3 | 10 | 16 | 25 | 50 | 6.3 | 10 | 16 | 25 | 50 | 6.3 | 10 | 16 | 25 | 50 | | | | | | | | | |
| CAP (µF) | | | | | | | | | | | | | | | | | | | | | | | | | | | | | |
| 0.001 | | | | | | | | | | | | | | | | | | | | | | | | | | | | | |
| 0.0022 | | | | | | | | | | | | | | | | | | | | | | | | | | | | | |
| 0.0047 | | | | | | | | | | | | | | | | | | | | | | | | | | | | | |
| 0.010 | | | | | | | | | | | | | | | | | | | | | | | | | | | | | |
| 0.015 | | | | | | | | | | | | | | | | | | | | | | | | | | | | | |
| 0.022 | | | | | | | | | | | | | | | | | | | | | | | | | | | | | |
| 0.047 | | | | | | | | | | | | | | | | | | | | | | | | | | | | | |
| 0.068 | | | | | | | | | | | | | | | | | | | | | | | | | | | | | |
| 0.10 | | | | | | | | | | | | | | | | | | | | | | | | | | | | | |
| 0.15 | | | | | | | | | | | | | | | | | | | | | | | | | | | | | |
| 0.22 | | | | | | | | | | | | | | | | | | | | | | | | | | | | | |
| 0.47 | | | | | | | | | | | | | | | | | | | | | | | | | | | | | |
| 0.68 | | | | | | | | | | | | | | | | | | | | | | | | | | | | | |
| 1.0 | | | | | | | | | | | | | | | | | | | | | | | | | | | | | |
| 1.5 | | | | | | | | | | | | | | | | | | | | | | | | | | | | | |
| 2.2 | | | | | | | | | | | | | | | | | | | | | | | | | | | | | |
| 3.3 | | | | | | | | | | | | | | | | | | | | | | | | | | | | | |
| 4.7 | | | | | | | | | | | | | | | | | | | | | | | | | | | | | |
| 10 | | | | | | | | | | | | | | | | | | | | | | | | | | | | | |

PHYSICAL DIMENSIONS AND PAD LAYOUT

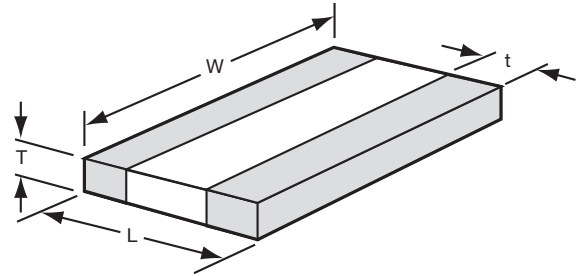

PHYSICAL CHIP DIMENSIONS mm (in)

| | L | W | t |
|-------------|--------------------------------|--------------------------------|--------------------------------|
| 0612 | 1.60 ± 0.25 (0.063 ± 0.010) | 3.20 ± 0.25 (0.126 ± 0.010) | 0.13 min. (0.005 min.) |
| 0508 | 1.27 ± 0.25 (0.050 ± 0.010) | 2.00 ± 0.25 (0.080 ± 0.010) | 0.13 min. (0.005 min.) |
| 0306 | 0.81 ± 0.15 (0.032 ± 0.006) | 1.60 ± 0.15 (0.063 ± 0.006) | 0.13 min. (0.005 min.) |
| 0204 | 0.50 ± 0.05 (0.020 ± 0.002) | 1.00 ± 0.05 (0.040 ± 0.002) | 0.18 ± 0.08 (0.007 ± 0.003) |

T - See Range Chart for Thickness and Codes

PAD LAYOUT DIMENSIONS mm (in)

| | A | B | C |
|-------------|--------------|--------------|--------------|
| 0612 | 0.76 (0.030) | 3.05 (0.120) | .635 (0.025) |
| 0508 | 0.51 (0.020) | 2.03 (0.080) | 0.51 (0.020) |
| 0306 | 0.31 (0.012) | 1.52 (0.060) | 0.51 (0.020) |
| 0204 | | | |

| Solid = X7R | | Diagonal lines = X5R | | Vertical lines = X7S | | Horizontal lines = X6S | |
|-------------|------------------|----------------------|------------------|----------------------|------------------|------------------------|------------------|
| mm (in.) | | mm (in.) | | mm (in.) | | mm (in.) | |
| 0204 | | 0306 | | 0508 | | 0612 | |
| Code | Thickness | Code | Thickness | Code | Thickness | Code | Thickness |
| C | 0.35 (0.014) | A | 0.61 (0.024) | S | 0.56 (0.022) | S | 0.56 (0.022) |
| | | | | V | 0.76 (0.030) | V | 0.76 (0.030) |
| | | | | A | 1.02 (0.040) | W | 1.02 (0.040) |
| | | | | | | A | 1.27 (0.050) |

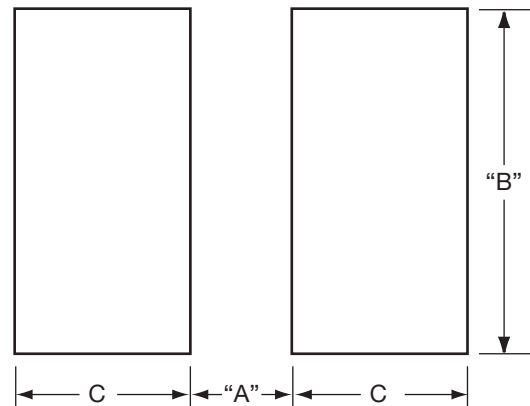

Low Inductance Capacitors (SnPb)



0612/0508/0306/0204 Tin Lead Termination "B"

GENERAL DESCRIPTION

The key physical characteristic determining equivalent series inductance (ESL) of a capacitor is the size of the current loop it creates. The smaller the current loop, the lower the ESL.

A standard surface mount MLCC is rectangular in shape with electrical terminations on its shorter sides. A Low Inductance Chip Capacitor (LICC) sometimes referred to as Reverse Geometry Capacitor (RGC) has its terminations on the longer sides of its rectangular shape. The image on the right shows the termination differences between an MLCC and an LICC.

When the distance between terminations is reduced, the size of the current loop is reduced. Since the size of the current loop is the primary driver of inductance, an 0306 with a smaller current loop has significantly lower ESL than an 0603. The reduction in ESL varies by EIA size, however, ESL is typically reduced 60% or more with an LICC versus a standard MLCC.

AVX LICC products are available with a lead termination for high reliability military and aerospace applications that must avoid tin whisker reliability issues.

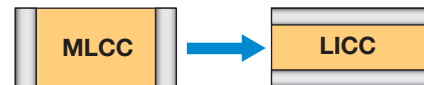
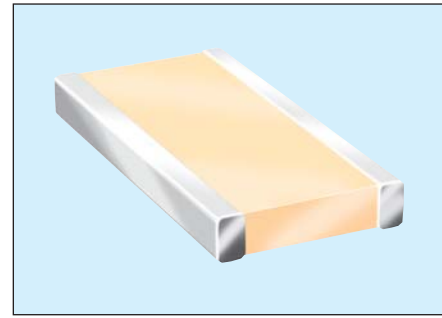

PERFORMANCE CHARACTERISTICS

| | |
|---|--|
| Capacitance Tolerances | K = $\pm 10\%$; M = $\pm 20\%$ |
| Operation Temperature Range | X7R = -55°C to $+125^{\circ}\text{C}$ X5R = -55°C to $+85^{\circ}\text{C}$ X7S = -55°C to $+125^{\circ}\text{C}$ |
| Temperature Coefficient | X7R, X5R = $\pm 15\%$; X7S = $\pm 22\%$ |
| Voltage Ratings | 4, 6.3, 10, 16, 25 VDC |
| Dissipation Factor | 4V, 6.3V = 6.5% max; 10V = 5.0% max; 16V = 3.5% max; 25V = 3.0% max |
| Insulation Resistance (@+25°C, RVDC) | 100,000M Ω min, or 1,000M Ω per μF min., whichever is less |

HOW TO ORDER

| | | | | | | | | |
|--|--|-------------------------------|------------------------------------|----------------------------------|---------------------|---------------------|-----------------------------|---|
| LD18 | Z | D | 105 | M | A | B | 2 | A* |
| Size | Voltage | Dielectric | Capacitance Code (In pF) | Capacitance Tolerance | Failure Rate | Terminations | Packaging Available | Thickness |
| LD15 = 0204 LD16 = 0306 LD17 = 0508 LD18 = 0612 | 4 = 4V 6 = 6.3V Z = 10V Y = 16V 3 = 25V 5 = 50V | C = X7R D = X5R W = X6S | 2 Sig. Digits + Number of Zeros | K = $\pm 10\%$ M = $\pm 20\%$ | A = N/A | B = 5% min lead | 2 = 7" Reel 4 = 13" Reel | mm (in) 0.35 (0.014) 0.56 (0.022) 0.61 (0.024) 0.76 (0.030) 1.02 (0.040) 1.27 (0.050) |

NOTE: Contact factory for availability of Termination and Tolerance Options for Specific Part Numbers.

TYPICAL IMPEDANCE CHARACTERISTICS

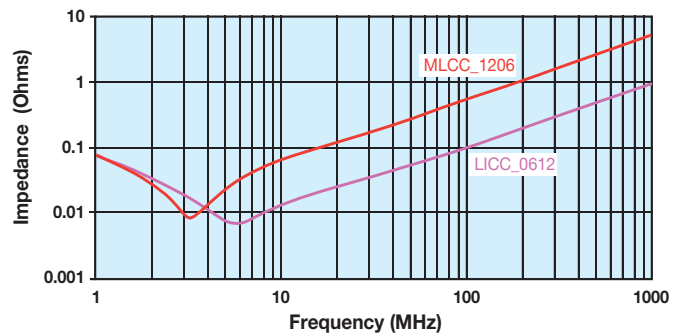
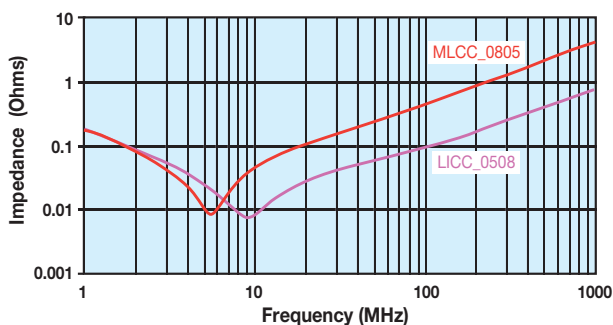

Low Inductance Capacitors (SnPb)



0612/0508/0306/0204 Tin Lead Termination "B"

PREFERRED SIZES ARE SHADED

| SIZE | LD15 | | | | LD16 | | | | LD17 | | | | LD18 | | | | | | |
|---------------------|-------------|-----|----|----|--------------------------------|----|----|----|--------------------------------|-----|----|----|--------------------------------|----|-----|----|----|----|----|
| Soldering | | | | | Reflow Only | | | | Reflow Only | | | | Reflow/Wave | | | | | | |
| Packaging | | | | | All Paper | | | | All Paper | | | | Paper/Embossed | | | | | | |
| (L) Length mm (in.) | | | | | 0.81 ± 0.15 (0.032 ± 0.006) | | | | 1.27 ± 0.25 (0.050 ± 0.010) | | | | 1.60 ± 0.25 (0.063 ± 0.010) | | | | | | |
| (W) Width mm (in.) | | | | | 1.60 ± 0.15 (0.063 ± 0.006) | | | | 2.00 ± 0.25 (0.080 ± 0.010) | | | | 3.20 ± 0.25 (0.126 ± 0.010) | | | | | | |
| WVDC | 4 | 6.3 | 10 | 16 | 6.3 | 10 | 16 | 25 | 50 | 6.3 | 10 | 16 | 25 | 50 | 6.3 | 10 | 16 | 25 | 50 |
| Cap (pF) | 1000 | | | | A | A | A | A | | S | S | S | S | V | S | S | S | S | V |
| | 2200 | | | | A | A | A | A | | S | S | S | S | V | S | S | S | S | V |
| | 4700 | | | | A | A | A | A | | S | S | S | S | V | S | S | S | S | V |
| Cap (µF) | 0.010 | | | | A | A | A | A | | S | S | S | S | V | S | S | S | S | V |
| | 0.015 | | | | A | A | A | A | | S | S | S | S | V | S | S | S | S | V |
| | 0.022 | | | | A | A | A | A | | S | S | S | S | V | S | S | S | S | V |
| | 0.047 | | | | A | A | A | | S | S | S | V | A | | S | S | S | S | V |
| | 0.068 | | | | A | A | A | | S | S | S | V | A | | S | S | S | V | W |
| | 0.10 | C | C | | A | A | A | | S | S | V | A | | S | S | S | V | W | |
| | 0.15 | | | | A | A | | | S | S | V | | | S | S | S | W | W | |
| | 0.22 | | | | A | A | | | S | S | V | A | | S | S | V | | | |
| | 0.47 | | | | | | | | V | V | A | | | S | S | V | | | |
| | 0.68 | | | | | | | | A | A | | | | V | V | W | | | |
| | 1.0 | | | | | | | | A | A | | | | V | V | W | | | |
| | 1.5 | | | | | | | | A | A | | | | W | W | A | | | |
| | 2.2 | | | | | | | | | | | | | A | A | | | | |
| | 3.3 | | | | | | | | | | | | | | | | | | |
| | 4.7 | | | | | | | | | | | | | | | | | | |
| | 10 | | | | | | | | | | | | | | | | | | |
| WVDC | 4 | 6.3 | 10 | 16 | 6.3 | 10 | 16 | 25 | 50 | 6.3 | 10 | 16 | 25 | 50 | 6.3 | 10 | 16 | 25 | 50 |
| SIZE | 0204 | | | | 0306 | | | | 0508 | | | | 0612 | | | | | | |

Solid = X7R

= X5R

= X7S

= X6S

| mm (in.) | |
|-------------|--------------|
| LD15 - 0204 | |
| Code | Thickness |
| C | 0.35 (0.014) |

| mm (in.) | |
|-------------|--------------|
| LD16 - 0306 | |
| Code | Thickness |
| A | 0.61 (0.024) |

| mm (in.) | |
|-------------|--------------|
| LD17 - 0508 | |
| Code | Thickness |
| S | 0.56 (0.022) |
| V | 0.76 (0.030) |
| A | 1.02 (0.040) |

| mm (in.) | |
|-------------|--------------|
| LD18 - 0612 | |
| Code | Thickness |
| S | 0.56 (0.022) |
| V | 0.76 (0.030) |
| W | 1.02 (0.040) |
| A | 1.27 (0.050) |

PHYSICAL DIMENSIONS AND PAD LAYOUT

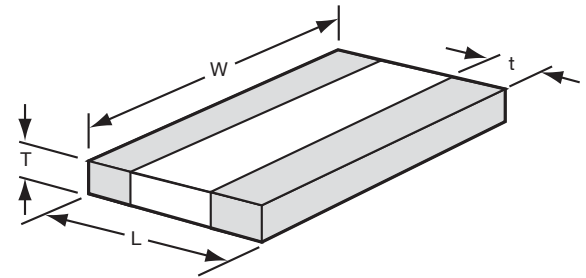

PHYSICAL CHIP DIMENSIONS mm (in)

| | L | W | t |
|------|--------------------------------|--------------------------------|--------------------------------|
| 0612 | 1.60 ± 0.25 (0.063 ± 0.010) | 3.20 ± 0.25 (0.126 ± 0.010) | 0.13 min. (0.005 min.) |
| 0508 | 1.27 ± 0.25 (0.050 ± 0.010) | 2.00 ± 0.25 (0.080 ± 0.010) | 0.13 min. (0.005 min.) |
| 0306 | 0.81 ± 0.15 (0.032 ± 0.006) | 1.60 ± 0.15 (0.063 ± 0.006) | 0.13 min. (0.005 min.) |
| 0204 | 0.50 ± 0.05 (0.020 ± 0.002) | 1.00 ± 0.05 (0.040 ± 0.002) | 0.18 ± 0.08 (0.007 ± 0.003) |

T - See Range Chart for Thickness and Codes

PAD LAYOUT DIMENSIONS mm (in)

| | A | B | C |
|------|--------------|--------------|--------------|
| 0612 | 0.76 (0.030) | 3.05 (0.120) | .635 (0.025) |
| 0508 | 0.51 (0.020) | 2.03 (0.080) | 0.51 (0.020) |
| 0306 | 0.31 (0.012) | 1.52 (0.060) | 0.51 (0.020) |
| 0204 | | | |

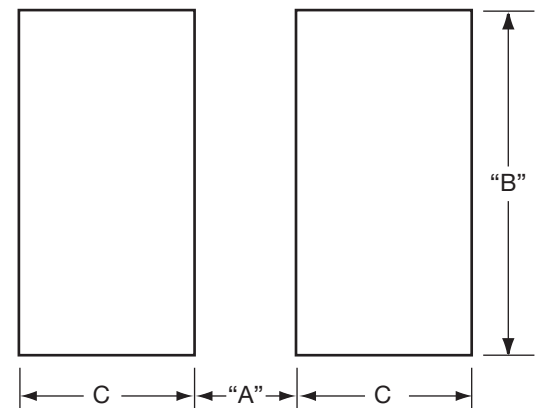

IDC Low Inductance Capacitors (RoHS)

0612/0508 IDC (InterDigitated Capacitors)

GENERAL DESCRIPTION

Inter-Digitated Capacitors (IDCs) are used for both semiconductor package and board level decoupling. The equivalent series inductance (ESL) of a single capacitor or an array of capacitors in parallel determines the response time of a Power Delivery Network (PDN). The lower the ESL of a PDN, the faster the response time. A designer can use many standard MLCCs in parallel to reduce ESL or a low ESL Inter-Digitated Capacitor (IDC) device. These IDC devices are available in versions with a maximum height of 0.95mm or 0.55mm.

IDCs are typically used on packages of semiconductor products with power levels of 15 watts or greater. Inter-Digitated Capacitors are used on CPU, GPU, ASIC, and ASSP devices produced on 0.13 μ m, 90nm, 65nm, and 45nm processes. IDC devices are used on both ceramic and organic package substrates. These low ESL surface mount capacitors can be placed on the bottom side or the top side of a package substrate. The low profile 0.55mm maximum height IDCs can easily be used on the bottom side of BGA packages or on the die side of packages under a heat spreader.

IDCs are used for board level decoupling of systems with speeds of 300MHz or greater. Low ESL IDCs free up valuable board space by reducing the number of capacitors required versus standard MLCCs. There are additional benefits to reducing the number of capacitors beyond saving board space including higher reliability from a reduction in the number of components and lower placement costs based on the need for fewer capacitors.

The Inter-Digitated Capacitor (IDC) technology was developed by AVX. This is the second family of Low Inductance MLCC products created by AVX. IDCs are a cost effective alternative to AVX's first generation low ESL family for high-reliability applications known as LICA (Low Inductance Chip Array).

AVX IDC products are available with a lead-free finish of plated Nickel/Tin.

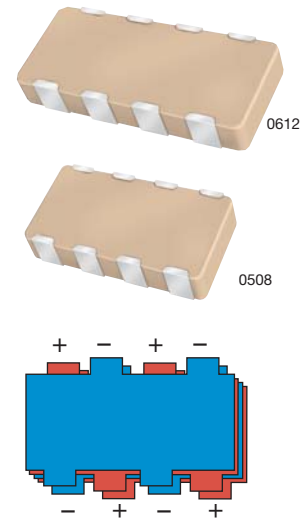

TYPICAL IMPEDANCE

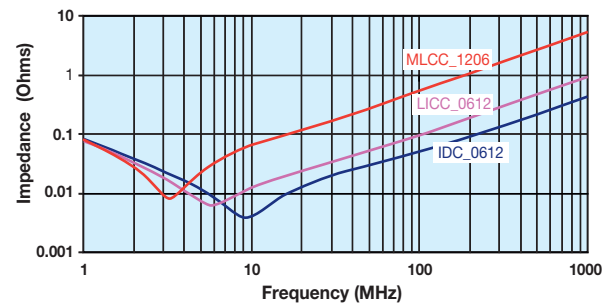

HOW TO ORDER

| | | | | | | | | | | | |
|--------------|----------------------|-----------------------|----------------------------|---|-------------------------------|---------------------------------|------------------------------|---------------------|----------------------|--------------------------------------|--|
| W | 3 | L | 1 | 6 | D | 225 | M | A | T | 3 | A |
| Style | IDC Case Size | Low Inductance | Number of Terminals | Voltage | Dielectric | Capacitance Code (In pF) | Capacitance Tolerance | Failure Rate | Termination | Packaging | Thickness |
| | 2 = 0508 3 = 0612 | | 1 = 8 Terminals | 4 = 4V 6 = 6.3V Z = 10V Y = 16V 3 = 25V | C = X7R D = X5R Z = X7S | 2 Sig. Digits + Number of Zeros | M = $\pm 20\%$ | A = N/A | T = Plated Ni and Sn | Available 1=7" Reel 3=13" Reel | Max. Thickness mm (in.) A=0.95 (0.037) S=0.55 (0.022) |

NOTE: Contact factory for availability of Termination and Tolerance Options for Specific Part Numbers.

PERFORMANCE CHARACTERISTICS

| | |
|---|---|
| Capacitance Tolerance | $\pm 20\%$ Preferred |
| Operation Temperature Range | X7R = -55°C to +125°C X5R = -55°C to +85°C X7S = -55°C to +125°C |
| Temperature Coefficient | $\pm 15\%$ (0VDC) |
| Voltage Ratings | 4, 6.3, 10, 16 VDC |
| Dissipation Factor | 4V, 6.3V = 6.5% max; 10V = 5.0% max; 16V = 3.5% max |
| Insulation Resistance (@+25°C, RVDC) | 100,000M Ω min, or 1,000M Ω per μ F min., whichever is less |

| | |
|-------------------------------|---|
| Dielectric Strength | No problems observed after 2.5 x RVDC for 5 seconds at 50mA max current |
| CTE (ppm/C) | 12.0 |
| Thermal Conductivity | 4-5W/M K |
| Terminations Available | Plated Nickel and Solder |
| Max. Thickness | 0.037" (0.95mm) |

IDC Low Inductance Capacitors (RoHS)

0612/0508 IDC (InterDigitated Capacitors)

| SIZE | Thin 0508 | | | | | 0508 | | | | | Thin 0612 | | | | 0612 | | | |
|----------------|--------------------------------|-----|----|----|----|--------------------------------|-----|----|----|----|--------------------------------|-----|----|----|--------------------------------|-----|----|----|
| Length | 2.03 ± 0.20 (0.080 ± 0.008) | | | | | 2.03 ± 0.20 (0.080 ± 0.008) | | | | | 3.20 ± 0.20 (0.126 ± 0.008) | | | | 3.20 ± 0.20 (0.126 ± 0.008) | | | |
| Width | 1.27 ± 0.20 (0.050 ± 0.008) | | | | | 1.27 ± 0.20 (0.050 ± 0.008) | | | | | 1.60 ± 0.20 (0.063 ± 0.008) | | | | 1.60 ± 0.20 (0.063 ± 0.008) | | | |
| Terminal Pitch | 0.50 ± 0.05 (0.020 ± 0.002) | | | | | 0.50 ± 0.05 (0.020 ± 0.002) | | | | | 0.80 ± 0.10 (0.031 ± 0.004) | | | | 0.80 ± 0.10 (0.031 ± 0.004) | | | |
| Thickness | 0.55 MAX. (0.022) MAX. | | | | | 0.95 MAX. (0.037) MAX. | | | | | 0.55 MAX. (0.022) MAX. | | | | 0.95 MAX. (0.037) MAX. | | | |
| WVDC | 4 | 6.3 | 10 | 16 | 25 | 4 | 6.3 | 10 | 16 | 25 | 4 | 6.3 | 10 | 16 | 4 | 6.3 | 10 | 16 |
| Cap (µF) | 0.01 | | | | | 0.033 | | | | | 0.047 | | | | 0.068 | | | |
| | 0.10 | | | | | 0.22 | | | | | 0.33 | | | | 0.47 | | | |
| | 0.68 | | | | | 1.0 | | | | | 1.5 | | | | 2.2 | | | |
| | 3.3 | | | | | | | | | | | | | | | | | |

Consult factory for additional requirements

- = X7R
- = X5R
- = X7S

PHYSICAL DIMENSIONS AND PAD LAYOUT

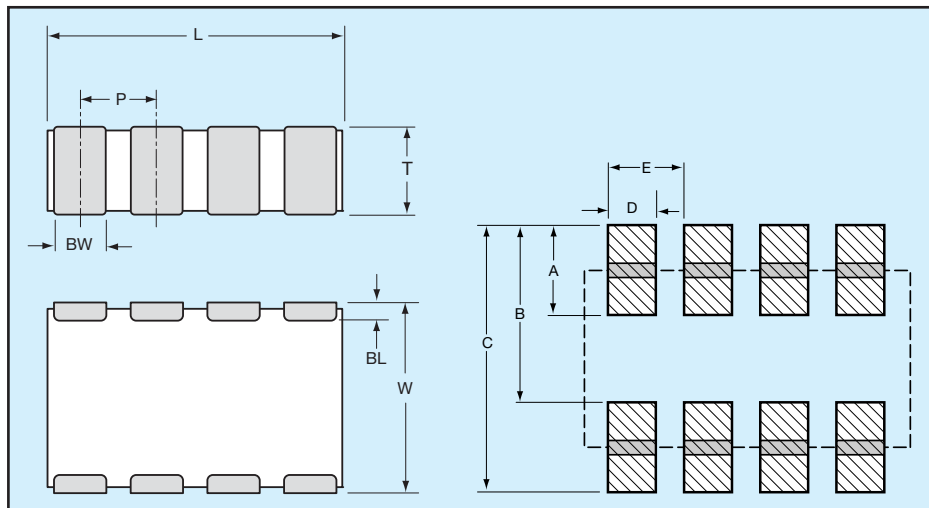

PHYSICAL CHIP DIMENSIONS millimeters (inches)

0612

| L | W | BW | BL | P |
|--------------------------------|--------------------------------|--------------------------------|--|--------------------------------|
| 3.20 ± 0.20 (0.126 ± 0.008) | 1.60 ± 0.20 (0.063 ± 0.008) | 0.41 ± 0.10 (0.016 ± 0.004) | 0.18 ^{+0.25} _{-0.08} (0.007 ^{+0.010} _{-0.003}) | 0.80 ± 0.10 (0.031 ± 0.004) |

0508

| L | W | BW | BL | P |
|--------------------------------|--------------------------------|--|--|--------------------------------|
| 2.03 ± 0.20 (0.080 ± 0.008) | 1.27 ± 0.20 (0.050 ± 0.008) | 0.25 ^{+0.15} _{-0.10} (0.010 ^{+0.006} _{-0.004}) | 0.18 ^{+0.25} _{-0.08} (0.007 ^{+0.010} _{-0.003}) | 0.50 ± 0.05 (0.020 ± 0.002) |

PAD LAYOUT DIMENSIONS

0612

| A | B | C | D | E |
|-----------------|-----------------|-----------------|-----------------|-----------------|
| 0.89 (0.035) | 1.65 (0.065) | 2.54 (0.100) | 0.46 (0.018) | 0.80 (0.031) |

0508

| A | B | C | D | E |
|-----------------|-----------------|-----------------|-----------------|-----------------|
| 0.64 (0.025) | 1.27 (0.050) | 1.91 (0.075) | 0.28 (0.011) | 0.50 (0.020) |

IDC Low Inductance Capacitors (SnPb)

0612/0508 IDC with Sn/Pb Termination

GENERAL DESCRIPTION

Inter-Digitated Capacitors (IDCs) are used for both semiconductor package and board level decoupling. The equivalent series inductance (ESL) of a single capacitor or an array of capacitors in parallel determines the response time of a Power Delivery Network (PDN). The lower the ESL of a PDN, the faster the response time. A designer can use many standard MLCCs in parallel to reduce ESL or a low ESL Inter-Digitated Capacitor (IDC) device. These IDC devices are available in versions with a maximum height of 0.95mm or 0.55mm.

IDCs are typically used on packages of semiconductor products with power levels of 15 watts or greater. Inter-Digitated Capacitors are used on CPU, GPU, ASIC, and ASSP devices produced on 0.13μ, 90nm, 65nm, and 45nm processes. IDC devices are used on both ceramic and organic package substrates. These low ESL surface mount capacitors can be placed on the bottom side or the top side of a package substrate. The low profile 0.55mm maximum height IDCs can easily be used on the bottom side of BGA packages or on the die side of packages under a heat spreader.

IDCs are used for board level decoupling of systems with speeds of 300MHz or greater. Low ESL IDCs free up valuable board space by reducing the number of capacitors required versus standard MLCCs. There are additional benefits to reducing the number of capacitors beyond saving board space including higher reliability from a reduction in the number of components and lower placement costs based on the need for fewer capacitors.

The Inter-Digitated Capacitor (IDC) technology was developed by AVX. This is the second family of Low Inductance MLCC products created by AVX. IDCs are a cost effective alternative to AVX's first generation low ESL family for high-reliability applications known as LICA (Low Inductance Chip Array).

AVX IDC products are available with a lead termination for high reliability military and aerospace applications that must avoid tin whisker reliability issues.

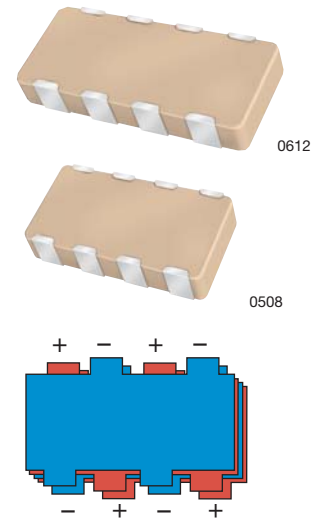

TYPICAL IMPEDANCE

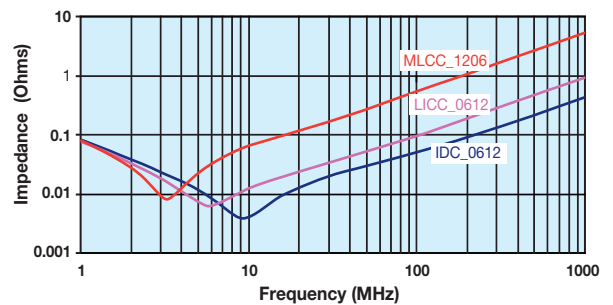

HOW TO ORDER

| | | | | | | | | | | | |
|--------------|----------------------|-----------------------|----------------------------|---|-------------------------------|---------------------------------|------------------------------|---------------------|--------------------|----------------------------|---|
| L | 3 | L | 1 | 6 | D | 225 | M | A | B | 3 | A |
| Style | IDC Case Size | Low Inductance | Number of Terminals | Voltage | Dielectric | Capacitance Code (In pF) | Capacitance Tolerance | Failure Rate | Termination | Packaging Available | Thickness |
| | 2 = 0508 3 = 0612 | | 1 = 8 Terminals | 4 = 4V 6 = 6.3V Z = 10V Y = 16V 3 = 25V | C = X7R D = X5R Z = X7S | 2 Sig. Digits + Number of Zeros | M = ±20% | A = N/A | B = 5% min. Lead | 1=7" Reel 3=13" Reel | <u>Max. Thickness</u> mm (in.) A=0.95 (0.037) S=0.55 (0.022) |

NOTE: Contact factory for availability of Termination and Tolerance Options for Specific Part Numbers.

PERFORMANCE CHARACTERISTICS

| | |
|---|--|
| Capacitance Tolerance | ±20% Preferred |
| Operation Temperature Range | X7R = -55°C to +125°C X5R = -55°C to +85°C X7S = -55°C to +125°C |
| Temperature Coefficient | ±15% (0VDC) |
| Voltage Ratings | 4, 6.3, 10, 16 VDC |
| Dissipation Factor | 4V, 6.3V = 6.5% max; 10V = 5.0% max; 16V = 3.5% max |
| Insulation Resistance (@+25°C, RVDC) | 100,000MΩ min, or 1,000MΩ per μF min., whichever is less |

| | |
|-------------------------------|---|
| Dielectric Strength | No problems observed after 2.5 x RVDC for 5 seconds at 50mA max current |
| CTE (ppm/C) | 12.0 |
| Thermal Conductivity | 4-5W/M K |
| Terminations Available | Plated Nickel and 5% min. Lead |
| Max. Thickness | 0.037" (0.95mm) |

IDC Low Inductance Capacitors (SnPb)

0612/0508 IDC with Sn/Pb Termination

| SIZE | Thin 0508 | | | | | 0508 | | | | | Thin 0612 | | | | 0612 | | | |
|----------------|--------------------------------|-----|----|----|----|--------------------------------|-----|----|----|----|--------------------------------|-----|----|----|--------------------------------|-----|----|----|
| Length | 2.03 ± 0.20 (0.080 ± 0.008) | | | | | 2.03 ± 0.20 (0.080 ± 0.008) | | | | | 3.20 ± 0.20 (0.126 ± 0.008) | | | | 3.20 ± 0.20 (0.126 ± 0.008) | | | |
| Width | 1.27 ± 0.20 (0.050 ± 0.008) | | | | | 1.27 ± 0.20 (0.050 ± 0.008) | | | | | 1.60 ± 0.20 (0.063 ± 0.008) | | | | 1.60 ± 0.20 (0.063 ± 0.008) | | | |
| Terminal Pitch | 0.50 ± 0.05 (0.020 ± 0.002) | | | | | 0.50 ± 0.05 (0.020 ± 0.002) | | | | | 0.80 ± 0.10 (0.031 ± 0.004) | | | | 0.80 ± 0.10 (0.031 ± 0.004) | | | |
| Thickness | 0.55 MAX. (0.022) MAX. | | | | | 0.95 MAX. (0.037) MAX. | | | | | 0.55 MAX. (0.022) MAX. | | | | 0.95 MAX. (0.037) MAX. | | | |
| WVDC | 4 | 6.3 | 10 | 16 | 25 | 4 | 6.3 | 10 | 16 | 25 | 4 | 6.3 | 10 | 16 | 4 | 6.3 | 10 | 16 |
| Cap (µF) | 0.01 | | | | | 0.033 | | | | | 0.047 | | | | 0.068 | | | |
| | 0.10 | | | | | 0.22 | | | | | 0.33 | | | | 0.47 | | | |
| | 0.68 | | | | | 1.0 | | | | | 1.5 | | | | 2.2 | | | |
| | 3.3 | | | | | | | | | | | | | | | | | |

Consult factory for additional requirements

-  = X7R
-  = X5R
-  = X7S

PHYSICAL DIMENSIONS AND PAD LAYOUT

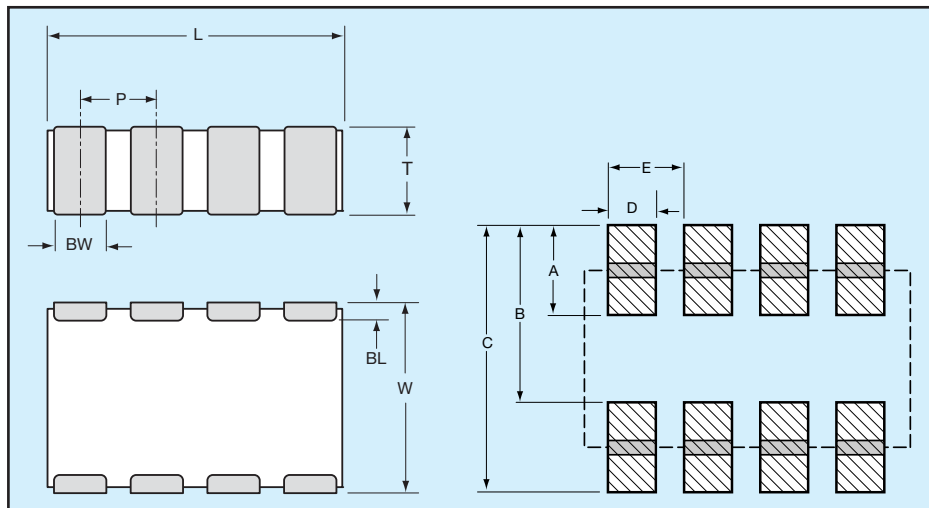

PHYSICAL CHIP DIMENSIONS millimeters (inches)

0612

| L | W | BW | BL | P |
|--------------------------------|--------------------------------|--------------------------------|--|--------------------------------|
| 3.20 ± 0.20 (0.126 ± 0.008) | 1.60 ± 0.20 (0.063 ± 0.008) | 0.41 ± 0.10 (0.016 ± 0.004) | 0.18 ^{+0.25} _{-0.08} (0.007 ^{+0.010} _{-0.003}) | 0.80 ± 0.10 (0.031 ± 0.004) |

0508

| L | W | BW | BL | P |
|--------------------------------|--------------------------------|---------------------------------|--|--------------------------------|
| 2.03 ± 0.20 (0.080 ± 0.008) | 1.27 ± 0.20 (0.050 ± 0.008) | 0.254 ± 0.10 (0.010 ± 0.004) | 0.18 ^{+0.25} _{-0.08} (0.007 ^{+0.010} _{-0.003}) | 0.50 ± 0.05 (0.020 ± 0.002) |

PAD LAYOUT DIMENSIONS

0612

| A | B | C | D | E |
|-----------------|-----------------|-----------------|-----------------|-----------------|
| 0.89 (0.035) | 1.65 (0.065) | 2.54 (0.100) | 0.46 (0.018) | 0.80 (0.031) |

0508

| A | B | C | D | E |
|-----------------|-----------------|-----------------|-----------------|-----------------|
| 0.64 (0.025) | 1.27 (0.050) | 1.91 (0.075) | 0.28 (0.011) | 0.50 (0.020) |

LGA Low Inductance Capacitors



0204/0306/0805 Land Grid Arrays

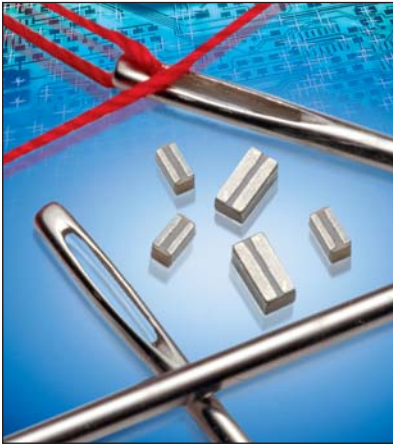

Land Grid Array (LGA) capacitors are the latest family of low inductance MLCCs from AVX. These new LGA products are the third low inductance family developed by AVX. The innovative LGA technology sets a new standard for low inductance MLCC performance. *Electronic Products* awarded its 2006 Product of the Year Award to the LGA Decoupling capacitor.

Our initial 2 terminal versions of LGA technology deliver the performance of an 8 terminal IDC low inductance MLCC with a number of advantages including:

- Simplified layout of 2 large solder pads compared to 8 small pads for IDCs
- Opportunity to reduce PCB or substrate contribution to system ESL by using multiple parallel vias in solder pads
- Advanced FCT manufacturing process used to create uniformly flat terminations on the capacitor that resist “tombstoning”
- Better solder joint reliability

APPLICATIONS

Semiconductor Packages

- Microprocessors/CPU's
- Graphics Processors/GPU's
- Chipsets
- FPGA's
- ASIC's

Board Level Device Decoupling

- Frequencies of 300 MHz or more
- IC's drawing 15W or more
- Low voltages
- High speed buses



0306 2 TERMINAL LGA COMPARISON WITH 0306 8 TERMINAL IDC

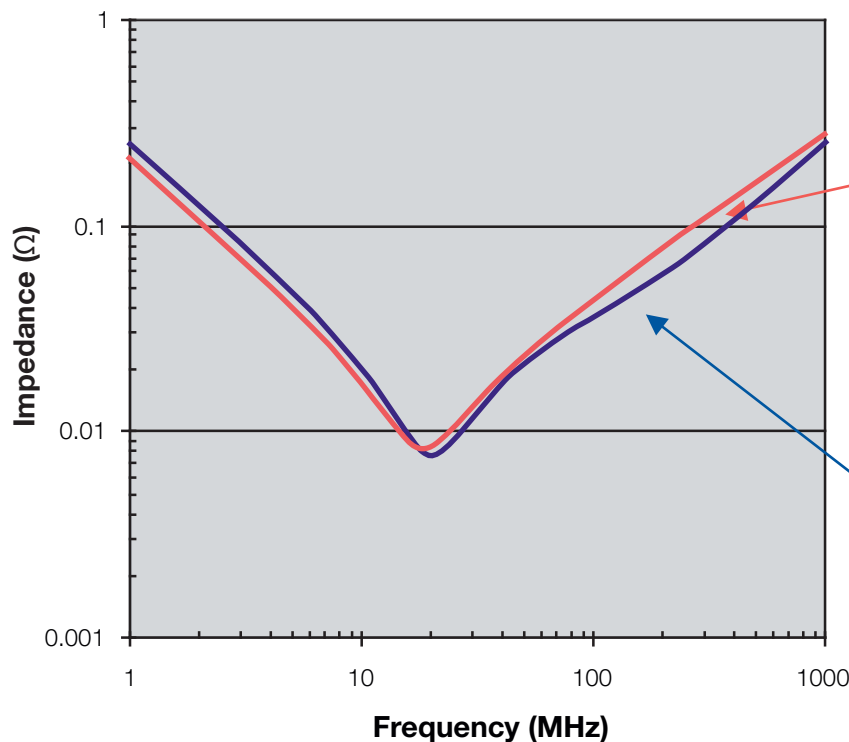

LGA Low Inductance Capacitors



0204/0306/0805 Land Grid Arrays

| SIZE | LG12 (0204) | | | | | | LG22 (0306) | | | | | | LGC2 (0805) | | | | | | | | | | |
|-----------------|--------------|-------|---------|-------|---------|-------|--------------|---------|---------|---------|---------|---------|--------------|---------|---------|---------|---------|---------|---------|---------|---------|---------|-------|
| Length mm (in.) | 0.50 (0.020) | | | | | | 0.76 (0.030) | | | | | | 2.06 (0.081) | | | | | | | | | | |
| Width mm (in.) | 1.00 (0.039) | | | | | | 1.60 (0.063) | | | | | | 1.32 (0.052) | | | | | | | | | | |
| Temp. Char. | X5R (D) | | X7S (Z) | | X6S (W) | | X7R (C) | | X5R (D) | | X7S (Z) | | X6S (W) | | X7R (C) | | X5R (D) | | X7S (Z) | | X6S (W) | | |
| Working Voltage | 6.3 (6) | 4 (4) | 6.3 (6) | 4 (4) | 6.3 (6) | 4 (4) | 10 (Z) | 6.3 (6) | 4 (4) | 6.3 (6) | 4 (4) | 6.3 (6) | 4 (4) | 6.3 (6) | 4 (4) | 6.3 (6) | 4 (4) | 6.3 (6) | 4 (4) | 6.3 (6) | 4 (4) | 6.3 (6) | 4 (4) |
| Cap (μF) | 0.010 (103) | | | | | | | | | | | | | | | | | | | | | | |
| | 0.022 (223) | | | | | | | | | | | | | | | | | | | | | | |
| | 0.047 (473) | | | | | | | | | | | | | | | | | | | | | | |
| | 0.100 (104) | | | | | | | | | | | | | | | | | | | | | | |
| | 0.220 (224) | | | | | | | | | | | | | | | | | | | | | | |
| | 0.330 (334) | | | | | | | | | | | | | | | | | | | | | | |
| | 0.470 (474) | | | | | | | | | | | | | | | | | | | | | | |
| | 1.000 (105) | | | | | | | | | | | | | | | | | | | | | | |
| | 2.200 (225) | | | | | | | | | | | | | | | | | | | | | | |

= X7R
 = X5R
 = X7S
 = X6S

Please contact AVX for values

HOW TO ORDER

| | | | | | | | | | | | |
|-----------|----------------------------------|---------------------|-------------------------------|--|------------|---------------|-------------------|---|-----------------------------|--------------------------|----------------------|
| LG | 1 | 2 | 6 | Z | 104 | M | A | T | 2 | S | 1 |
| Style | Case Size | Number of Terminals | Working Voltage | Temperature Characteristic | Coded Cap | Cap Tolerance | Termination Style | Termination 100% Sn* | Packaging Tape & Reel | Thickness S = 0.55mm max | Number of Capacitors |
| | 1 = 0204 2 = 0306 C = 0805 | 2 | 4 = 4V 6 = 6.3V Z = 10V | C = X7R D = X5R Z = X7S W = X6S | | M = 20% | A = "U" Land | *Contact factory for other termination finishes | 2 = 7" Reel 4 = 13" Reel | | |

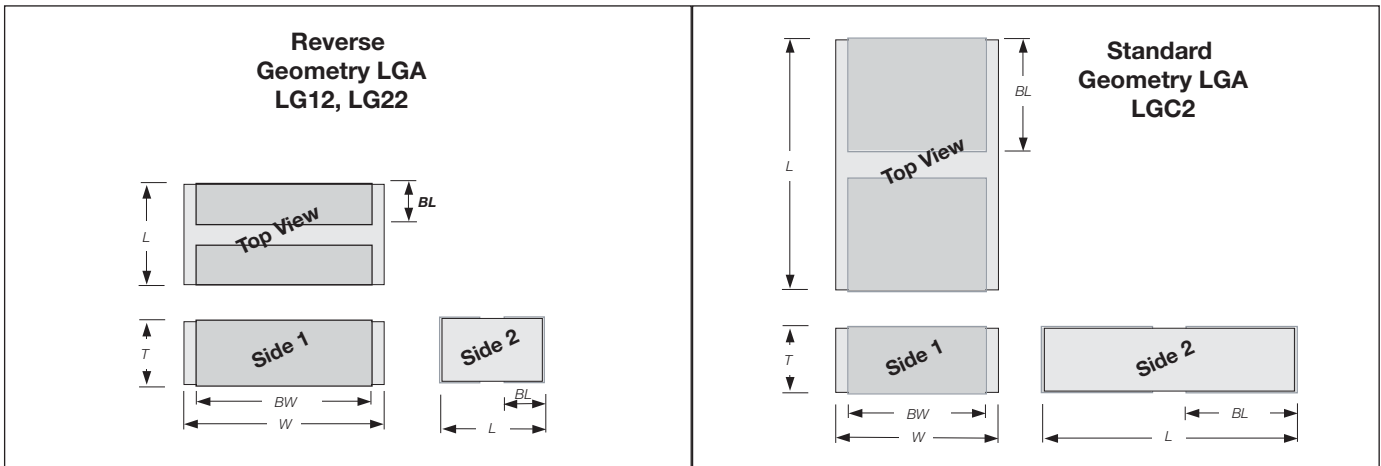

PART DIMENSIONS

mm (inches)

| Series | L | W | T | BW | BL |
|-------------|--------------------------------|--------------------------------|--------------------------------|--------------------------------|--------------------------------|
| LG12 (0204) | 0.5 ± 0.05 (0.020 ± 0.002) | 1.00 ± 0.10 (0.039 ± 0.004) | 0.50 ± 0.05 (0.020 ± 0.002) | 0.8 ± 0.10 (0.031 ± 0.004) | 0.13 ± 0.08 (0.005 ± 0.003) |
| LG22 (0306) | 0.76 ± 0.10 (0.030 ± 0.004) | 1.60 ± 0.10 (0.063 ± 0.004) | 0.50 ± 0.05 (0.020 ± 0.002) | 1.50 ± 0.10 (0.059 ± 0.004) | 0.28 ± 0.08 (0.011 ± 0.003) |
| LGC2 (0805) | 2.06 ± 0.10 (0.081 ± 0.004) | 1.32 ± 0.10 (0.052 ± 0.004) | 0.50 ± 0.05 (0.020 ± 0.002) | 1.14 ± 0.10 (0.045 ± 0.004) | 0.90 ± 0.08 (0.035 ± 0.003) |

RECOMMENDED SOLDER PAD DIMENSIONS

mm (inches)

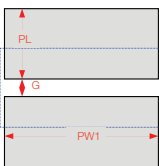

| Series | PL | PW1 | G |
|-------------|--------------|--------------|--------------|
| LG12 (0204) | 0.50 (0.020) | 1.00 (0.039) | 0.20 (0.008) |
| LG22 (0306) | 0.65 (0.026) | 1.50 (0.059) | 0.20 (0.008) |
| LGC2 (0805) | 1.25 (0.049) | 1.40 (0.055) | 0.20 (0.008) |

Low Inductance Capacitors



LICA® (Low Inductance Decoupling Capacitor Arrays)

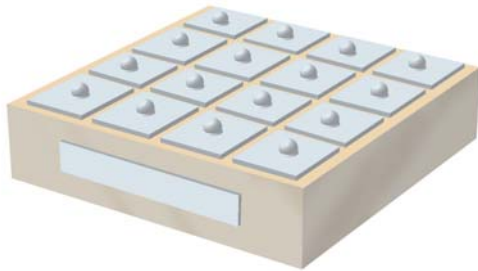

LICA® arrays utilize up to four separate capacitor sections in one ceramic body (see Configurations and Capacitance Options). These designs exhibit a number of technical advancements:

Low Inductance features—

- Low resistance platinum electrodes in a low aspect ratio pattern
- Double electrode pickup and perpendicular current paths
- C4 “flip-chip” technology for minimal interconnect inductance

HOW TO ORDER

| LICA | 3 | T | 102 | M | 3 | F | C | 4 | A | A |
|--------------|------------------------------|---|--|-----------------------|---|---|---|--------------------------------|--|--|
| Style & Size | Voltage | Dielectric | Cap/Section (EIA Code) | Capacitance Tolerance | Height Code | Termination | Reel Packaging | # of Caps/Part | Inspection Code | Code Face |
| | 5V = 9 10V = Z 25V = 3 | D = X5R T = T55T S = High K T55T | 102 = 1000 pF 103 = 10 nF 104 = 100 nF | M = ±20% P = GMV | 6 = 0.500mm 3 = 0.650mm 1 = 0.875mm 5 = 1.100mm 7 = 1.600mm | F = C4 Solder Balls- 97Pb/3Sn H = C4 Solder Balls Low ESR G = Lead Free SAC R = Cr-Cu-Au N = Cr-Ni-Au V = Eutectic Lead-Tin Bump-37%Pb/63%Sn X = None | M = 7" Reel R = 13" Reel 6 = 2"x2" Waffle Pack 8 = 2"x2" Black Waffle Pack 7 = 2"x2" Waffle Pack w/ termination facing up A = 2"x2" Black Waffle Pack w/ termination facing up C = 4"x4" Waffle Pack w/ clear lid | 1 = one 2 = two 4 = four | A = Standard B = COTS+ X = MIL-PRF-123 | A = Bar B = No Bar C = Dot, S55S Dielectrics D = Triangle |

TABLE 1

| Typical Parameters | T55T/S55S | Units |
|--|-------------------|----------------|
| Capacitance, 25°C | Co | Nanofarads |
| Capacitance, 55°C | 1.45 x Co | Nanofarads |
| Capacitance, 85°C | 0.7 x Co | Nanofarads |
| Dissipation Factor 25° | 15 | Percent |
| ESR (Nominal) | 20 | Milliohms |
| DC Resistance | 0.2 | Ohms |
| IR (Minimum @25°) (Design Dependent) | 300 | Megaohms |
| Dielectric Breakdown, Min | 500 | Volts |
| Thermal Coefficient of Expansion | 8.5 | ppm/°C 25-100° |
| Inductance: (Design Dependent) (Nominal) | 30 | Pico-Henries |
| Frequency of Operation | DC to 5 Gigahertz | |
| Ambient Temp Range | -55° to 125°C | |

NOTE: Contact factory for availability of Termination and Tolerance Options for Specific Part Numbers.

SOLDER BALL AND PAD DIMENSIONS

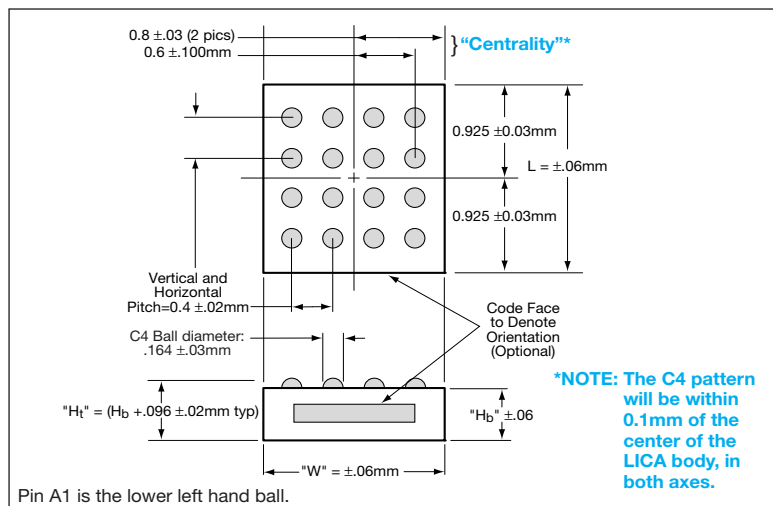

Pin A1 is the lower left hand ball.

| Code (Body Height) | Width (W) | Length (L) | Height Body (H _b) |
|--------------------|-----------|------------|-------------------------------|
| 1 | 1.600mm | 1.850mm | 0.875mm |
| 3 | 1.600mm | 1.850mm | 0.650mm |
| 5 | 1.600mm | 1.850mm | 1.100mm |
| 6 | 1.600mm | 1.850mm | 0.500mm |
| 7 | 1.600mm | 1.850mm | 1.600mm |

TERMINATION OPTIONS

SOLDER BALLS
TERMINATION OPTION F, H, G OR V

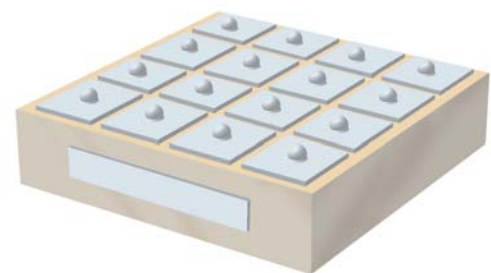

TERMINATION OPTION R OR N

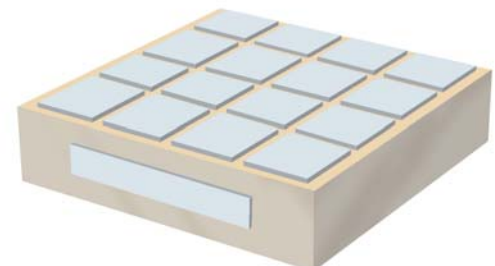

Low Inductance Capacitors



LICA® (Low Inductance Decoupling Capacitor Arrays)

TEMPERATURE VS CAPACITANCE CHANGE

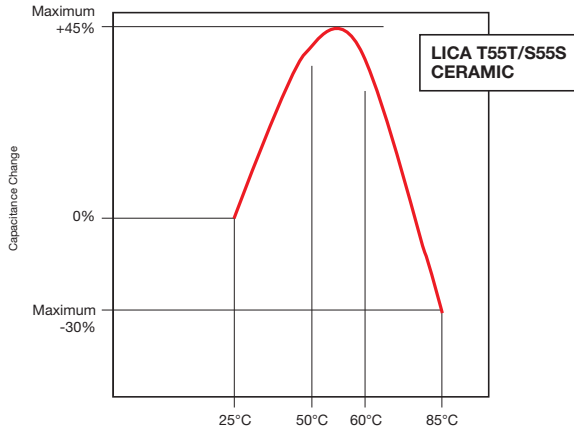

TYPICAL S21 FOR LICA AT SINGLE VIA

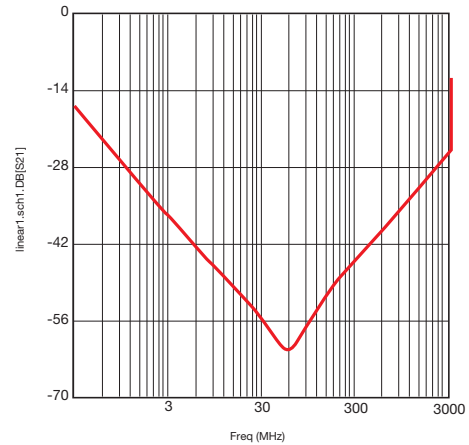

LICA COMMON PART NUMBER LIST

| Part Number | Voltage | Thickness (mm) | Capacitors per Package |
|-----------------------|---------|----------------|------------------------|
| LICA3T193M3FC4AA | 25 | 0.650 | 4 |
| LICA3T153P3FC4AA | 25 | 0.650 | 4 |
| LICA3T134M1FC1AA | 25 | 0.875 | 1 |
| LICA3T104P1FC1AA | 25 | 0.875 | 1 |
| LICA3T333M1FC4AA | 25 | 0.875 | 4 |
| LICA3T263P3FC4AA | 25 | 0.650 | 4 |
| LICA3T244M5FC1AA | 25 | 1.100 | 1 |
| LICA3T194P5FC1AA | 25 | 1.100 | 1 |
| LICA3T394M7FC1AB | 25 | 1.600 | 1 |
| LICA3T314P7FC1AB | 25 | 1.600 | 1 |
| Extended Range | | | |
| LICAZT623M3FC4AB | 10 | 0.650 | 4 |
| LICA3T104M3FC1A | 25 | 0.650 | 1 |
| LICA3T803P3FC1A | 25 | 0.650 | 1 |
| LICA3T423M3FC2A | 25 | 0.650 | 2 |
| LICA3T333P3FC2A | 25 | 0.650 | 2 |
| LICA3S253M3FC4A | 25 | 0.650 | 4 |
| LICAZD753M3FC4AD | 10 | 0.650 | 4 |
| LICAZD504M3FC1AB | 10 | 0.650 | 1 |
| LICAZD604M7FC1AB | 10 | 1.600 | 1 |
| LICA3D193M3FC4AB | 25 | 0.650 | 4 |

CONFIGURATION

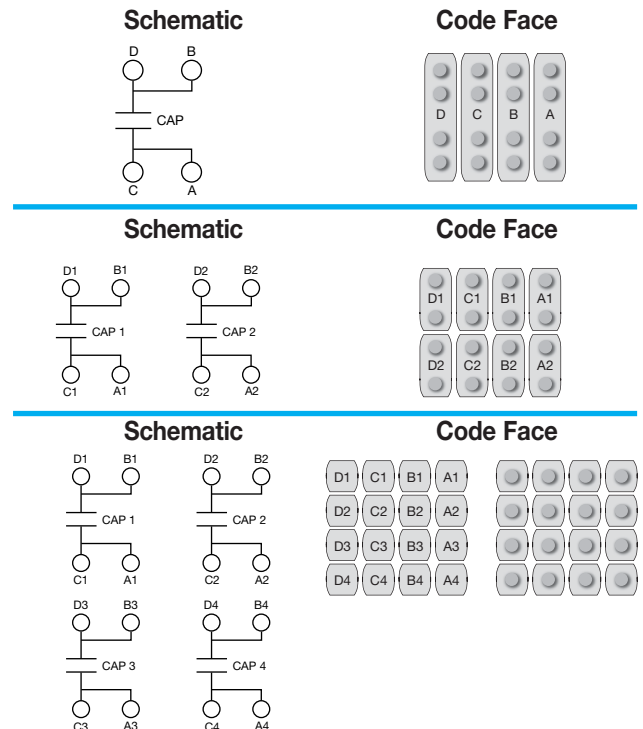

WAFFLE PACK OPTIONS FOR LICA®

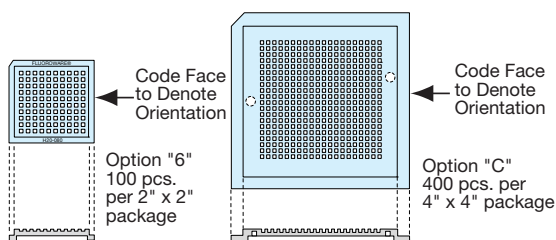

Note: Standard configuration is Termination side down

LICA® PACKAGING SCHEME "M" AND "R"

8mm conductive plastic tape on reel:
"M"=7" reel max. qty. 3,000, "R"=13" reel max. qty. 8,000

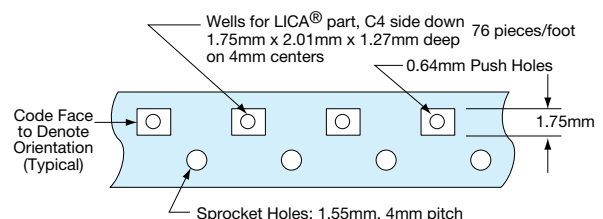

High Voltage MLC Chips



For 600V to 5000V Application

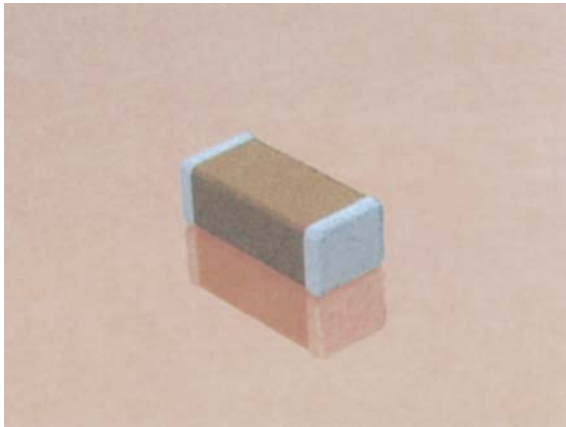

High value, low leakage and small size are difficult parameters to obtain in capacitors for high voltage systems. AVX special high voltage MLC chip capacitors meet these performance characteristics and are designed for applications such as snubbers in high frequency power converters, resonators in SMPS, and high voltage coupling/dc blocking. These high voltage chip designs exhibit low ESRs at high frequencies.

Larger physical sizes than normally encountered chips are used to make high voltage MLC chip products. Special precautions must be taken in applying these chips in surface mount assemblies. The temperature gradient during heating or cooling cycles should not exceed 4°C per second. The preheat temperature must be within 50°C of the peak temperature reached by the ceramic bodies through the soldering process. Chip sizes 1210 and larger should be reflow soldered only. Capacitors may require protective surface coating to prevent external arcing.

NEW 630V RANGE

HOW TO ORDER

| 1808 | A | A | 271 | K | A | 1 | 1 | A |
|------------------|----------------|--------------------------------|--|------------------------------|-------------------|-------------------------------|------------------|---------------------|
| AVX Style | Voltage | Temperature Coefficient | Capacitance Code (2 significant digits + no. of zeros) | Capacitance Tolerance | Test Level | Termination* | Packaging | Special Code |
| 0805 | 600V/630V = C | COG = A | Examples: 10 pF = 100 | COG: J = ±5% | A = Standard | 1 = Pd/Ag | 1 = 7" Reel | A = Standard |
| 1206 | 1000V = A | X7R = C | 100 pF = 101 | K = ±10% | | T = Plated | 3 = 13" Reel | |
| 1210 | 1500V = S | | 1,000 pF = 102 | X7R: K = ±10% | | Ni and Sn (RoHS Compliant) | 9 = Bulk | |
| 1808 | 2000V = G | | 22,000 pF = 223 | M = ±20% | | | | |
| 1812 | 2500V = W | | 220,000 pF = 224 | Z = +80%, -20% | | | | |
| 1825 | 3000V = H | | 1 μF = 105 | | | | | |
| 2220 | 4000V = J | | | | | | | |
| 2225 | 5000V = K | | | | | | | |
| 3640 | | | | | | | | |

*Note: Terminations with 5% minimum lead (Pb) is available, see pages 75 and 76 for LD style.

Notes: Capacitors with X7R dielectrics are not intended for applications across AC supply mains or AC line filtering with polarity reversal. Contact plant for recommendations. Contact factory for availability of Termination and Tolerance options for Specific Part Numbers.

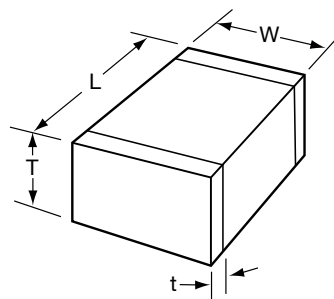

DIMENSIONS

millimeters (inches)

| SIZE | 0805 | 1206 | 1210* | 1808* | 1812* | 1825* | 2220* | 2225* | 3640* |
|------------------------------|--------------------------------|--------------------------------|--------------------------------|--------------------------------|--------------------------------|--------------------------------|--------------------------------|--------------------------------|--------------------------------|
| (L) Length | 2.01 ± 0.20 (0.079 ± 0.008) | 3.20 ± 0.20 (0.126 ± 0.008) | 3.20 ± 0.20 (0.126 ± 0.008) | 4.57 ± 0.25 (0.180 ± 0.010) | 4.50 ± 0.30 (0.177 ± 0.012) | 4.50 ± 0.30 (0.177 ± 0.012) | 5.70 ± 0.40 (0.224 ± 0.016) | 5.72 ± 0.25 (0.225 ± 0.010) | 9.14 ± 0.25 (0.360 ± 0.010) |
| (W) Width | 1.25 ± 0.20 (0.049 ± 0.008) | 1.60 ± 0.20 (0.063 ± 0.008) | 2.50 ± 0.20 (0.098 ± 0.008) | 2.03 ± 0.25 (0.080 ± 0.010) | 3.20 ± 0.20 (0.126 ± 0.008) | 6.40 ± 0.30 (0.252 ± 0.012) | 5.00 ± 0.40 (0.197 ± 0.016) | 6.35 ± 0.25 (0.250 ± 0.010) | 10.2 ± 0.25 (0.400 ± 0.010) |
| (T) Thickness Max. | 1.30 (0.051) | 1.52 (0.060) | 1.70 (0.067) | 2.03 (0.080) | 2.54 (0.100) | 2.54 (0.100) | 3.30 (0.130) | 2.54 (0.100) | 2.54 (0.100) |
| (t) terminal min. max. | 0.50 ± 0.25 (0.020 ± 0.010) | 0.25 (0.010) 0.75 (0.030) | 0.25 (0.010) 0.75 (0.030) | 0.25 (0.010) 1.02 (0.040) | 0.25 (0.010) 1.02 (0.040) | 0.25 (0.010) 1.02 (0.040) | 0.25 (0.010) 1.02 (0.040) | 0.25 (0.010) 1.02 (0.040) | 0.76 (0.030) 1.52 (0.060) |

*Reflow Soldering Only



High Voltage MLC Chips



For 600V to 5000V Applications

C0G Dielectric

Performance Characteristics

| | |
|---|--|
| Capacitance Range | 10 pF to 0.047 μ F (25°C, 1.0 \pm 0.2 Vrms at 1kHz, for \leq 1000 pF use 1 MHz) |
| Capacitance Tolerances | \pm 5%, \pm 10%, \pm 20% |
| Dissipation Factor | 0.1% max. (+25°C, 1.0 \pm 0.2 Vrms, 1kHz, for \leq 1000 pF use 1 MHz) |
| Operating Temperature Range | -55°C to +125°C |
| Temperature Characteristic | 0 \pm 30 ppm/°C (0 VDC) |
| Voltage Ratings | 600, 630, 1000, 1500, 2000, 2500, 3000, 4000 & 5000 VDC (+125°C) |
| Insulation Resistance (+25°C, at 500 VDC) | 100K M Ω min. or 1000 M Ω - μ F min., whichever is less |
| Insulation Resistance (+125°C, at 500 VDC) | 10K M Ω min. or 100 M Ω - μ F min., whichever is less |
| Dielectric Strength | Minimum 120% rated voltage for 5 seconds at 50 mA max. current |

HIGH VOLTAGE C0G CAPACITANCE VALUES

| VOLTAGE | 0805 | 1206 | 1210 | 1808 | 1812 | 1825 | 2220 | 2225 | 3640 | |
|---------|------|-------|---------|---------|---------|---------|---------------|---------------|---------------|---------------|
| 600/630 | min. | 10pF | 10 pF | 100 pF | 100 pF | 100 pF | 1000 pF | 1000 pF | 1000 pF | 1000 pF |
| | max. | 330pF | 1200 pF | 2700 pF | 3300 pF | 5600 pF | 0.012 μ F | 0.012 μ F | 0.018 μ F | 0.047 μ F |
| 1000 | min. | 10pF | 10 pF | 10 pF | 100 pF | 100 pF | 100 pF | 1000 pF | 1000 pF | 1000 pF |
| | max. | 180pF | 560 pF | 1500 pF | 2200 pF | 3300 pF | 8200 pF | 0.010 μ F | 0.010 μ F | 0.022 μ F |
| 1500 | min. | — | 10 pF | 10 pF | 10 pF | 10 pF | 100 pF | 100 pF | 100 pF | 100 pF |
| | max. | — | 270 pF | 680 pF | 820 pF | 1800 pF | 4700 pF | 4700 pF | 5600 pF | 0.010 μ F |
| 2000 | min. | — | 10 pF | 10 pF | 10 pF | 10 pF | 100 pF | 100 pF | 100 pF | 100 pF |
| | max. | — | 120 pF | 270 pF | 330 pF | 1000 pF | 1800 pF | 2200 pF | 2700 pF | 6800 pF |
| 2500 | min. | — | — | — | 10 pF | 10 pF | 100 pF | 100 pF | 100 pF | 100 pF |
| | max. | — | — | — | 180 pF | 470 pF | 1200 pF | 1500 pF | 1800 pF | 3900 pF |
| 3000 | min. | — | — | — | 10 pF | 10 pF | 10 pF | 10 pF | 10 pF | 100 pF |
| | max. | — | — | — | 120 pF | 330 pF | 820 pF | 1000 pF | 1200 pF | 2700 pF |
| 4000 | min. | — | — | — | 10 pF | 10 pF | 10 pF | 10 pF | 10 pF | 100 pF |
| | max. | — | — | — | 47 pF | 150 pF | 330 pF | 470 pF | 560 pF | 1200 pF |
| 5000 | min. | — | — | — | — | — | — | 10 pF | 10 pF | 10 pF |
| | max. | — | — | — | — | — | — | 220 pF | 270 pF | 820 pF |

X7R Dielectric

Performance Characteristics

| | |
|---|---|
| Capacitance Range | 10 pF to 0.56 μ F (25°C, 1.0 \pm 0.2 Vrms at 1kHz) |
| Capacitance Tolerances | \pm 10%; \pm 20%; +80%, -20% |
| Dissipation Factor | 2.5% max. (+25°C, 1.0 \pm 0.2 Vrms, 1kHz) |
| Operating Temperature Range | -55°C to +125°C |
| Temperature Characteristic | \pm 15% (0 VDC) |
| Voltage Ratings | 600, 630, 1000, 1500, 2000, 2500, 3000, 4000 & 5000 VDC (+125°C) |
| Insulation Resistance (+25°C, at 500 VDC) | 100K M Ω min. or 1000 M Ω - μ F min., whichever is less |
| Insulation Resistance (+125°C, at 500 VDC) | 10K M Ω min. or 100 M Ω - μ F min., whichever is less |
| Dielectric Strength | Minimum 120% rated voltage for 5 seconds at 50 mA max. current |

HIGH VOLTAGE X7R MAXIMUM CAPACITANCE VALUES

| VOLTAGE | 0805 | 1206 | 1210 | 1808 | 1812 | 1825 | 2220 | 2225 | 3640 | |
|-------------|------|--------|---------------|---------------|---------------|---------------|---------------|---------------|---------------|---------------|
| 600/630 | min. | 100pF | 1000 pF | 1000 pF | 1000 pF | 1000 pF | 0.010 μ F | 0.010 μ F | 0.010 μ F | 0.010 μ F |
| | max. | 6800pF | 0.022 μ F | 0.056 μ F | 0.056 μ F | 0.100 μ F | 0.180 μ F | 0.220 μ F | 0.220 μ F | 0.560 μ F |
| 1000 | min. | 100pF | 100 pF | 1000 pF | 1000 pF | 1000 pF | 1000 pF | 1000 pF | 1000 pF | 0.010 μ F |
| | max. | 1500pF | 6800 pF | 0.015 μ F | 0.018 μ F | 0.027 μ F | 0.100 μ F | 0.100 μ F | 0.100 μ F | 0.220 μ F |
| 1500 | min. | — | 100 pF | 100 pF | 100 pF | 100 pF | 1000 pF | 1000 pF | 1000 pF | 1000 pF |
| | max. | — | 2700 pF | 4700 pF | 6800 pF | 0.012 μ F | 0.033 μ F | 0.039 μ F | 0.047 μ F | 0.100 μ F |
| Development | min. | — | 10 pF | 100 pF | 100 pF | 100 pF | 1000 pF | 1000 pF | 1000 pF | 1000 pF |
| | max. | — | 1500 pF | 3900 pF | 3900 pF | 8200 pF | 0.027 μ F | 0.027 μ F | 0.033 μ F | 0.027 μ F |
| 2000 | min. | — | — | — | 10 pF | 10 pF | 100 pF | 100 pF | 100 pF | 1000 pF |
| | max. | — | — | — | 1800 pF | 3300 pF | 6800 pF | 8200 pF | 0.010 μ F | 0.022 μ F |
| Development | min. | — | — | — | 2200 pF | 5600 pF | 0.015 μ F | 0.018 μ F | 0.022 μ F | 0.022 μ F |
| | max. | — | — | — | 1500 pF | 2200 pF | 4700 pF | 4700 pF | 6800 pF | 0.018 μ F |
| 3000 | min. | — | — | — | 10 pF | 10 pF | 100 pF | 100 pF | 100 pF | 1000 pF |
| | max. | — | — | — | 1800 pF | 4700 pF | 0.012 μ F | 0.012 μ F | 0.015 μ F | 0.018 μ F |
| Development | min. | — | — | — | — | — | — | — | — | 100 pF |
| | max. | — | — | — | — | — | — | — | — | 6800 pF |
| 4000 | min. | — | — | — | — | — | — | — | — | 100 pF |
| | max. | — | — | — | — | — | — | — | — | 3300 pF |
| 5000 | min. | — | — | — | — | — | — | — | — | 100 pF |
| | max. | — | — | — | — | — | — | — | — | 3300 pF |



High Voltage MLC Chips Tin/Lead Termination "B"



For 600V to 5000V Application

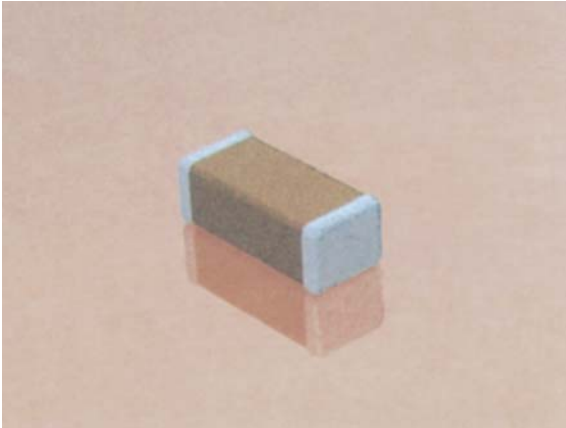

AVX Corporation will support those customers for commercial and military Multilayer Ceramic Capacitors with a termination consisting of 5% minimum lead. This termination is indicated by the use of a "B" in the 12th position of the AVX Catalog Part Number. This fulfills AVX's commitment to providing a full range of products to our customers. AVX has provided in the following pages, a full range of values that we are offering in this "B" termination.

Larger physical sizes than normally encountered chips are used to make high voltage MLC chip product. Special precautions must be taken in applying these chips in surface mount assemblies. The temperature gradient during heating or cooling cycles should not exceed 4°C per second. The preheat temperature must be within 50°C of the peak temperature reached by the ceramic bodies through the soldering process. Chip sizes 1210 and larger should be reflow soldered only. Capacitors may require protective surface coating to prevent external arcing.

NEW 630V RANGE

HOW TO ORDER

| LD08 | A | A | 271 | K | A | B | 1 | A |
|------------------|----------------------------|--------------------------------|---|---|-----------------------------------|-------------------------------------|---|-------------------------------------|
| AVX Style | Voltage | Temperature Coefficient | Capacitance Code (2 significant digits + no. of zeros) Examples: 10 pF = 100 100 pF = 101 1,000 pF = 102 22,000 pF = 223 220,000 pF = 224 1 μF = 105 | Capacitance Tolerance COG: J = ±5% K = ±10% M = ±20% X7R: K = ±10% M = ±20% Z = +80%, -20% | Test Level A = Standard | Termination B = 5% Min Pb | Packaging 1 = 7" Reel 3 = 13" Reel 9 = Bulk | Special Code A = Standard |
| LD05 - 0805 | 600V/630V = C 1000V = A | COG = A X7R = C | | | | | | |
| LD06 - 1206 | 1500V = S | | | | | | | |
| LD10 - 1210 | 2000V = G | | | | | | | |
| LD08 - 1808 | 2500V = W | | | | | | | |
| LD12 - 1812 | 3000V = H | | | | | | | |
| LD13 - 1825 | 4000V = J | | | | | | | |
| LD20 - 2220 | 5000V = K | | | | | | | |
| LD14 - 2225 | | | | | | | | |
| LD40 - 3640 | | | | | | | | |

Notes: Capacitors with X7R dielectrics are not intended for applications across AC supply mains or AC line filtering with polarity reversal. Contact plant for recommendations. Contact factory for availability of Termination and Tolerance options for Specific Part Numbers.

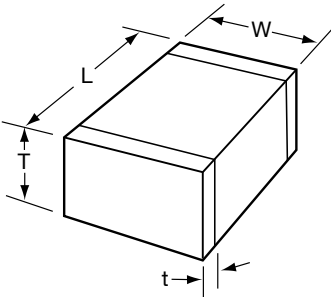

DIMENSIONS

millimeters (inches)

| SIZE | LD05 (0805) | LD06 (1206) | LD10* (1210) | LD08* (1808) | LD12* (1812) | LD13* (1825) | LD20* (2220) | LD25* (2225) | LD40* (3640) |
|------------------------------|--------------------------------|--------------------------------|--------------------------------|--------------------------------|--------------------------------|--------------------------------|--------------------------------|--------------------------------|--------------------------------|
| (L) Length | 2.01 ± 0.20 (0.079 ± 0.008) | 3.20 ± 0.20 (0.126 ± 0.008) | 3.20 ± 0.20 (0.126 ± 0.008) | 4.57 ± 0.25 (0.180 ± 0.010) | 4.50 ± 0.30 (0.177 ± 0.012) | 4.50 ± 0.30 (0.177 ± 0.012) | 5.70 ± 0.40 (0.224 ± 0.016) | 5.72 ± 0.25 (0.225 ± 0.010) | 9.14 ± 0.25 (0.360 ± 0.010) |
| (W) Width | 1.25 ± 0.20 (0.049 ± 0.008) | 1.60 ± 0.20 (0.063 ± 0.008) | 2.50 ± 0.20 (0.098 ± 0.008) | 2.03 ± 0.25 (0.080 ± 0.010) | 3.20 ± 0.20 (0.126 ± 0.008) | 6.40 ± 0.30 (0.252 ± 0.012) | 5.00 ± 0.40 (0.197 ± 0.016) | 6.35 ± 0.25 (0.250 ± 0.010) | 10.2 ± 0.25 (0.400 ± 0.010) |
| (T) Thickness Max. | 1.30 (0.051) | 1.52 (0.060) | 1.70 (0.067) | 2.03 (0.080) | 2.54 (0.100) | 2.54 (0.100) | 3.30 (0.130) | 2.54 (0.100) | 2.54 (0.100) |
| (t) terminal min. max. | 0.50 ± 0.25 (0.020 ± 0.010) | 0.25 (0.010) 0.75 (0.030) | 0.25 (0.010) 0.75 (0.030) | 0.25 (0.010) 1.02 (0.040) | 0.25 (0.010) 1.02 (0.040) | 0.25 (0.010) 1.02 (0.040) | 0.25 (0.010) 1.02 (0.040) | 0.25 (0.010) 1.02 (0.040) | 0.76 (0.030) 1.52 (0.060) |

* Reflow soldering only.



High Voltage MLC Chips Tin/Lead Termination “B”



For 600V to 5000V Application

C0G Dielectric Performance Characteristics

| | |
|---|--|
| Capacitance Range | 10 pF to 0.047 μ F (25°C, 1.0 \pm 0.2 Vrms at 1kHz, for \leq 1000 pF use 1 MHz) |
| Capacitance Tolerances | \pm 5%, \pm 10%, \pm 20% |
| Dissipation Factor | 0.1% max. (+25°C, 1.0 \pm 0.2 Vrms, 1kHz, for \leq 1000 pF use 1 MHz) |
| Operating Temperature Range | -55°C to +125°C |
| Temperature Characteristic | 0 \pm 30 ppm/°C (0 VDC) |
| Voltage Ratings | 600, 630, 1000, 1500, 2000, 2500, 3000, 4000 & 5000 VDC (+125°C) |
| Insulation Resistance (+25°C, at 500 VDC) | 100K M Ω min. or 1000 M Ω - μ F min., whichever is less |
| Insulation Resistance (+125°C, at 500 VDC) | 10K M Ω min. or 100 M Ω - μ F min., whichever is less |
| Dielectric Strength | Minimum 120% rated voltage for 5 seconds at 50 mA max. current |

HIGH VOLTAGE C0G CAPACITANCE VALUES

| VOLTAGE | LD05 (0805) | LD06 (1206) | LD10 (1210) | LD08 (1808) | LD12 (1812) | LD13 (1825) | LD20 (2220) | LD14 (2225) | LD40 (3640) |
|--------------|-------------|-------------|-------------|-------------|-------------|---------------|---------------|---------------|---------------|
| 600/630 min. | 10pF | 10 pF | 100 pF | 100 pF | 100 pF | 1000 pF | 1000 pF | 1000 pF | 1000 pF |
| 600/630 max. | 330pF | 1200 pF | 2700 pF | 3300 pF | 5600 pF | 0.012 μ F | 0.012 μ F | 0.018 μ F | 0.047 μ F |
| 1000 min. | 10pF | 10 pF | 10 pF | 100 pF | 100 pF | 100 pF | 1000 pF | 1000 pF | 1000 pF |
| 1000 max. | 180pF | 560 pF | 1500 pF | 2200 pF | 3300 pF | 8200 pF | 0.010 μ F | 0.010 μ F | 0.022 μ F |
| 1500 min. | — | 10 pF | 10 pF | 10 pF | 10 pF | 100 pF | 100 pF | 100 pF | 100 pF |
| 1500 max. | — | 270 pF | 680 pF | 820 pF | 1800 pF | 4700 pF | 4700 pF | 5600 pF | 0.010 μ F |
| 2000 min. | — | 10 pF | 10 pF | 10 pF | 10 pF | 100 pF | 100 pF | 100 pF | 100 pF |
| 2000 max. | — | 120 pF | 270 pF | 330 pF | 1000 pF | 1800 pF | 2200 pF | 2700 pF | 6800 pF |
| 2500 min. | — | — | — | 10 pF | 10 pF | 10 pF | 100 pF | 100 pF | 100 pF |
| 2500 max. | — | — | — | 180 pF | 470 pF | 1200 pF | 1500 pF | 1800 pF | 3900 pF |
| 3000 min. | — | — | — | 10 pF | 10 pF | 10 pF | 10 pF | 10 pF | 100 pF |
| 3000 max. | — | — | — | 120 pF | 330 pF | 820 pF | 1000 pF | 1200 pF | 2700 pF |
| 4000 min. | — | — | — | 10 pF | 10 pF | 10 pF | 10 pF | 10 pF | 100 pF |
| 4000 max. | — | — | — | 47 pF | 150 pF | 330 pF | 470 pF | 560 pF | 1200 pF |
| 5000 min. | — | — | — | — | — | — | 10 pF | 10 pF | 10 pF |
| 5000 max. | — | — | — | — | — | — | 220 pF | 270 pF | 820 pF |

X7R Dielectric Performance Characteristics

| | |
|---|---|
| Capacitance Range | 10 pF to 0.56 μ F (25°C, 1.0 \pm 0.2 Vrms at 1kHz) |
| Capacitance Tolerances | \pm 10%; \pm 20%; +80%, -20% |
| Dissipation Factor | 2.5% max. (+25°C, 1.0 \pm 0.2 Vrms, 1kHz) |
| Operating Temperature Range | -55°C to +125°C |
| Temperature Characteristic | \pm 15% (0 VDC) |
| Voltage Ratings | 600, 630, 1000, 1500, 2000, 2500, 3000, 4000 & 5000 VDC (+125°C) |
| Insulation Resistance (+25°C, at 500 VDC) | 100K M Ω min. or 1000 M Ω - μ F min., whichever is less |
| Insulation Resistance (+125°C, at 500 VDC) | 10K M Ω min. or 100 M Ω - μ F min., whichever is less |
| Dielectric Strength | Minimum 120% rated voltage for 5 seconds at 50 mA max. current |

HIGH VOLTAGE X7R MAXIMUM CAPACITANCE VALUES

| VOLTAGE | LD05 (0805) | LD06 (1206) | LD10 (1210) | LD08 (1808) | LD12 (1812) | LD13 (1825) | LD20 (2220) | LD14 (2225) | LD40 (3640) |
|------------------|-------------|---------------|---------------|---------------|---------------|---------------|---------------|---------------|---------------|
| 600/630 min. | 100pF | 1000 pF | 1000 pF | 1000 pF | 1000 pF | 0.010 μ F | 0.010 μ F | 0.010 μ F | 0.010 μ F |
| 600/630 max. | 6800pF | 0.022 μ F | 0.056 μ F | 0.056 μ F | 0.100 μ F | 0.180 μ F | 0.220 μ F | 0.220 μ F | 0.560 μ F |
| 1000 min. | 100pF | 100 pF | 1000 pF | 1000 pF | 1000 pF | 1000 pF | 1000 pF | 1000 pF | 0.010 μ F |
| 1000 max. | 1500pF | 6800 pF | 0.015 μ F | 0.018 μ F | 0.027 μ F | 0.100 μ F | 0.100 μ F | 0.100 μ F | 0.220 μ F |
| 1500 min. | — | 100 pF | 100 pF | 100 pF | 100 pF | 1000 pF | 1000 pF | 1000 pF | 1000 pF |
| 1500 max. | — | 2700 pF | 4700 pF | 6800 pF | 0.012 μ F | 0.033 μ F | 0.039 μ F | 0.047 μ F | 0.100 μ F |
| 1500 Development | — | — | 6800 pF | — | 0.015 μ F | 0.056 μ F | 0.056 μ F | 0.068 μ F | — |
| 2000 min. | — | 10 pF | 100 pF | 100 pF | 100 pF | 100 pF | 1000 pF | 1000 pF | 1000 pF |
| 2000 max. | — | 1500 pF | 3300 pF | 2700 pF | 4700 pF | 0.010 μ F | 0.010 μ F | 0.022 μ F | 0.027 μ F |
| 2000 Development | — | — | 3900 pF | 3900 pF | 8200 pF | 0.027 μ F | 0.027 μ F | 0.033 μ F | — |
| 2500 min. | — | — | — | 10 pF | 10 pF | 100 pF | 100 pF | 100 pF | 1000 pF |
| 2500 max. | — | — | — | 1800 pF | 3300 pF | 6800 pF | 8200 pF | 0.010 μ F | 0.022 μ F |
| 2500 Development | — | — | — | 2200 pF | 5600 pF | 0.015 μ F | 0.018 μ F | 0.022 μ F | — |
| 3000 min. | — | — | — | 10 pF | 10 pF | 100 pF | 100 pF | 100 pF | 1000 pF |
| 3000 max. | — | — | — | 1500 pF | 2200 pF | 4700 pF | 4700 pF | 6800 pF | 0.018 μ F |
| 3000 Development | — | — | — | 1800 pF | 4700 pF | 0.012 μ F | 0.012 μ F | 0.015 μ F | — |
| 4000 min. | — | — | — | — | — | — | — | — | 100 pF |
| 4000 max. | — | — | — | — | — | — | — | — | 6800 pF |
| 5000 min. | — | — | — | — | — | — | — | — | 100 pF |
| 5000 max. | — | — | — | — | — | — | — | — | 3300 pF |



MIL-PRF-55681/Chips

Part Number Example
CDR01 thru CDR06

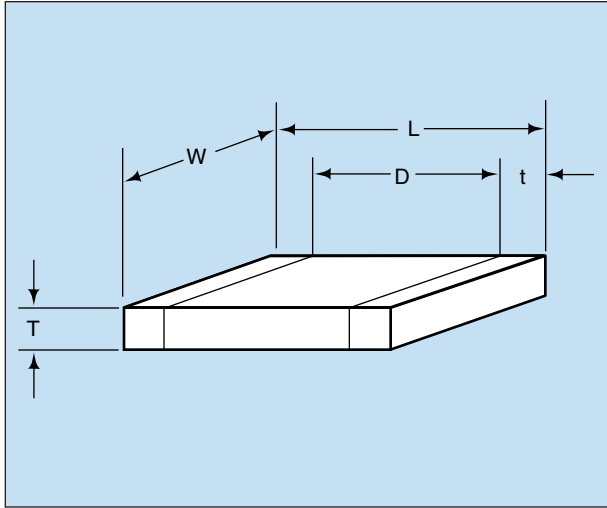

MILITARY DESIGNATION PER MIL-PRF-55681

Part Number Example

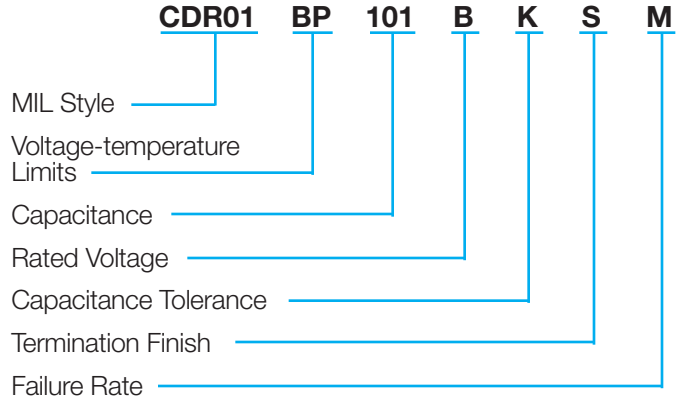

NOTE: Contact factory for availability of Termination and Tolerance Options for Specific Part Numbers.

MIL Style: CDR01, CDR02, CDR03, CDR04, CDR05, CDR06

Voltage Temperature Limits:

BP = 0 ± 30 ppm/°C without voltage; 0 ± 30 ppm/°C with rated voltage from -55°C to +125°C

BX = $\pm 15\%$ without voltage; $+15 -25\%$ with rated voltage from -55°C to +125°C

Capacitance: Two digit figures followed by multiplier (number of zeros to be added) e.g., 101 = 100 pF

Rated Voltage: A = 50V, B = 100V

Capacitance Tolerance: J $\pm 5\%$, K $\pm 10\%$, M $\pm 20\%$

Termination Finish:

M = Palladium Silver
 N = Silver Nickel Gold
 S = Solder-coated

U = Base Metallization/Barrier Metal/Solder Coated*
 W = Base Metallization/Barrier Metal/Tinned (Tin or Tin/Lead Alloy)

*Solder shall have a melting point of 200°C or less.

Failure Rate Level: M = 1.0%, P = .1%, R = .01%, S = .001%

Packaging: Bulk is standard packaging. Tape and reel per RS481 is available upon request.

CROSS REFERENCE: AVX/MIL-PRF-55681/CDR01 THRU CDR06*

| Per MIL-PRF-55681 | AVX Style | Length (L) | Width (W) | Thickness (T) | | D | | Termination Band (t) | |
|-------------------|-----------|---|---|---------------|------|------|------|----------------------|------|
| | | | | Max. | Min. | Max. | Min. | Max. | Min. |
| CDR01 | 0805 | .080 \pm .015 | .050 \pm .015 | .055 | .020 | — | .030 | — | .010 |
| CDR02 | 1805 | .180 \pm .015 | .050 \pm .015 | .055 | .020 | — | — | .030 | .010 |
| CDR03 | 1808 | .180 \pm .015 | .080 \pm .018 | .080 | .020 | — | — | .030 | .010 |
| CDR04 | 1812 | .180 \pm .015 | .125 \pm .015 | .080 | .020 | — | — | .030 | .010 |
| CDR05 | 1825 | .180 $\begin{smallmatrix} +.020 \\ -.015 \end{smallmatrix}$ | .250 $\begin{smallmatrix} +.020 \\ -.015 \end{smallmatrix}$ | .080 | .020 | — | — | .030 | .010 |
| CDR06 | 2225 | .225 \pm .020 | .250 \pm .020 | .080 | .020 | — | — | .030 | .010 |

*For CDR11, 12, 13, and 14 see AVX Microwave Chip Capacitor Catalog

MIL-PRF-55681/Chips

Military Part Number Identification

CDR01 thru CDR06



CDR01 thru CDR06 to MIL-PRF-55681

| Military Type Designation | Capacitance in pF | Capacitance tolerance | Rated temperature and voltage-temperature limits | WVDC |
|-----------------------------|-------------------|-----------------------|--|------|
| AVX Style 0805/CDR01 | | | | |
| CDR01BP100B--- | 10 | J,K | BP | 100 |
| CDR01BP120B--- | 12 | J | BP | 100 |
| CDR01BP150B--- | 15 | J,K | BP | 100 |
| CDR01BP180B--- | 18 | J | BP | 100 |
| CDR01BP220B--- | 22 | J,K | BP | 100 |
| CDR01BP270B--- | 27 | J | BP | 100 |
| CDR01BP330B--- | 33 | J,K | BP | 100 |
| CDR01BP390B--- | 39 | J | BP | 100 |
| CDR01BP470B--- | 47 | J,K | BP | 100 |
| CDR01BP560B--- | 56 | J | BP | 100 |
| CDR01BP680B--- | 68 | J,K | BP | 100 |
| CDR01BP820B--- | 82 | J | BP | 100 |
| CDR01BP101B--- | 100 | J,K | BP | 100 |
| CDR01B--121B--- | 120 | J,K | BP,BX | 100 |
| CDR01B--151B--- | 150 | J,K | BP,BX | 100 |
| CDR01B--181B--- | 180 | J,K | BP,BX | 100 |
| CDR01BX221B--- | 220 | K,M | BX | 100 |
| CDR01BX271B--- | 270 | K | BX | 100 |
| CDR01BX331B--- | 330 | K,M | BX | 100 |
| CDR01BX391B--- | 390 | K | BX | 100 |
| CDR01BX471B--- | 470 | K,M | BX | 100 |
| CDR01BX561B--- | 560 | K | BX | 100 |
| CDR01BX681B--- | 680 | K,M | BX | 100 |
| CDR01BX821B--- | 820 | K | BX | 100 |
| CDR01BX102B--- | 1000 | K,M | BX | 100 |
| CDR01BX122B--- | 1200 | K | BX | 100 |
| CDR01BX152B--- | 1500 | K,M | BX | 100 |
| CDR01BX182B--- | 1800 | K | BX | 100 |
| CDR01BX222B--- | 2200 | K,M | BX | 100 |
| CDR01BX272B--- | 2700 | K | BX | 100 |
| CDR01BX332B--- | 3300 | K,M | BX | 100 |
| CDR01BX392A--- | 3900 | K | BX | 50 |
| CDR01BX472A--- | 4700 | K,M | BX | 50 |
| AVX Style 1805/CDR02 | | | | |
| CDR02BP221B--- | 220 | J,K | BP | 100 |
| CDR02BP271B--- | 270 | J | BP | 100 |
| CDR02BX392B--- | 3900 | K | BX | 100 |
| CDR02BX472B--- | 4700 | K,M | BX | 100 |
| CDR02BX562B--- | 5600 | K | BX | 100 |
| CDR02BX682B--- | 6800 | K,M | BX | 100 |
| CDR02BX822B--- | 8200 | K | BX | 100 |
| CDR02BX103B--- | 10,000 | K,M | BX | 100 |
| CDR02BX123A--- | 12,000 | K | BX | 50 |
| CDR02BX153A--- | 15,000 | K,M | BX | 50 |
| CDR02BX183A--- | 18,000 | K | BX | 50 |
| CDR02BX223A--- | 22,000 | K,M | BX | 50 |

- Add appropriate failure rate
- Add appropriate termination finish
- Capacitance Tolerance

| Military Type Designation | Capacitance in pF | Capacitance tolerance | Rated temperature and voltage-temperature limits | WVDC |
|-----------------------------|-------------------|-----------------------|--|------|
| AVX Style 1808/CDR03 | | | | |
| CDR03BP331B--- | 330 | J,K | BP | 100 |
| CDR03BP391B--- | 390 | J | BP | 100 |
| CDR03BP471B--- | 470 | J,K | BP | 100 |
| CDR03BP561B--- | 560 | J | BP | 100 |
| CDR03BP681B--- | 680 | J,K | BP | 100 |
| CDR03BP821B--- | 820 | J | BP | 100 |
| CDR03BP102B--- | 1000 | J,K | BP | 100 |
| CDR03BX123B--- | 12,000 | K | BX | 100 |
| CDR03BX153B--- | 15,000 | K,M | BX | 100 |
| CDR03BX183B--- | 18,000 | K | BX | 100 |
| CDR03BX223B--- | 22,000 | K,M | BX | 100 |
| CDR03BX273B--- | 27,000 | K | BX | 100 |
| CDR03BX333B--- | 33,000 | K,M | BX | 100 |
| CDR03BX393A--- | 39,000 | K | BX | 50 |
| CDR03BX473A--- | 47,000 | K,M | BX | 50 |
| CDR03BX563A--- | 56,000 | K | BX | 50 |
| CDR03BX683A--- | 68,000 | K,M | BX | 50 |
| AVX Style 1812/CDR04 | | | | |
| CDR04BP122B--- | 1200 | J | BP | 100 |
| CDR04BP152B--- | 1500 | J,K | BP | 100 |
| CDR04BP182B--- | 1800 | J | BP | 100 |
| CDR04BP222B--- | 2200 | J,K | BP | 100 |
| CDR04BP272B--- | 2700 | J | BP | 100 |
| CDR04BP332B--- | 3300 | J,K | BP | 100 |
| CDR04BX393B--- | 39,000 | K | BX | 100 |
| CDR04BX473B--- | 47,000 | K,M | BX | 100 |
| CDR04BX563B--- | 56,000 | K | BX | 100 |
| CDR04BX823A--- | 82,000 | K | BX | 50 |
| CDR04BX104A--- | 100,000 | K,M | BX | 50 |
| CDR04BX124A--- | 120,000 | K | BX | 50 |
| CDR04BX154A--- | 150,000 | K,M | BX | 50 |
| CDR04BX184A--- | 180,000 | K | BX | 50 |
| AVX Style 1825/CDR05 | | | | |
| CDR05BP392B--- | 3900 | J,K | BP | 100 |
| CDR05BP472B--- | 4700 | J,K | BP | 100 |
| CDR05BP562B--- | 5600 | J,K | BP | 100 |
| CDR05BX683B--- | 68,000 | K,M | BX | 100 |
| CDR05BX823B--- | 82,000 | K | BX | 100 |
| CDR05BX104B--- | 100,000 | K,M | BX | 100 |
| CDR05BX124B--- | 120,000 | K | BX | 100 |
| CDR05BX154B--- | 150,000 | K,M | BX | 100 |
| CDR05BX224A--- | 220,000 | K,M | BX | 50 |
| CDR05BX274A--- | 270,000 | K | BX | 50 |
| CDR05BX334A--- | 330,000 | K,M | BX | 50 |
| AVX Style 2225/CDR06 | | | | |
| CDR06BP682B--- | 6800 | J,K | BP | 100 |
| CDR06BP822B--- | 8200 | J,K | BP | 100 |
| CDR06BP103B--- | 10,000 | J,K | BP | 100 |
| CDR06BX394A--- | 390,000 | K | BX | 50 |
| CDR06BX474A--- | 470,000 | K,M | BX | 50 |

- Add appropriate failure rate
- Add appropriate termination finish
- Capacitance Tolerance



MIL-PRF-55681/Chips

Part Number Example

CDR31 thru CDR35

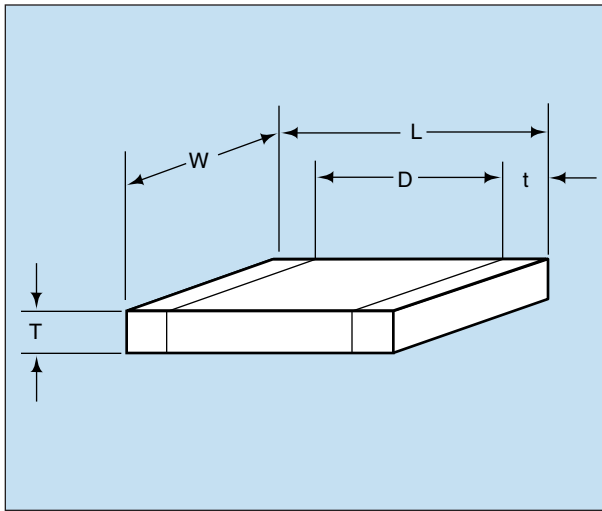

MILITARY DESIGNATION PER MIL-PRF-55681

Part Number Example

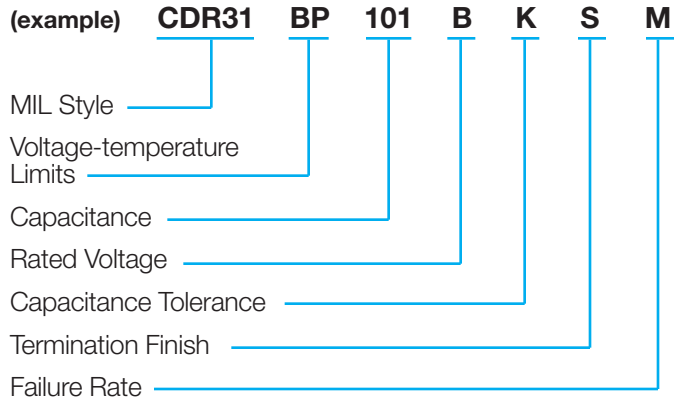

NOTE: Contact factory for availability of Termination and Tolerance Options for Specific Part Numbers.

MIL Style: CDR31, CDR32, CDR33, CDR34, CDR35

Voltage Temperature Limits:

BP = 0 ± 30 ppm/°C without voltage; 0 ± 30 ppm/°C with rated voltage from -55°C to +125°C

BX = $\pm 15\%$ without voltage; +15 -25% with rated voltage from -55°C to +125°C

Capacitance: Two digit figures followed by multiplier (number of zeros to be added) e.g., 101 = 100 pF

Rated Voltage: A = 50V, B = 100V

Capacitance Tolerance: B $\pm .10$ pF, C $\pm .25$ pF, D $\pm .5$ pF, F $\pm 1\%$, J $\pm 5\%$, K $\pm 10\%$, M $\pm 20\%$

Termination Finish:

M = Palladium Silver
N = Silver Nickel Gold
S = Solder-coated
Y = 100% Tin

U = Base Metallization/Barrier Metal/Solder Coated*
W = Base Metallization/Barrier Metal/Tinned (Tin or Tin/Lead Alloy)

*Solder shall have a melting point of 200°C or less.

Failure Rate Level: M = 1.0%, P = .1%, R = .01%, S = .001%

Packaging: Bulk is standard packaging. Tape and reel per RS481 is available upon request.

CROSS REFERENCE: AVX/MIL-PRF-55681/CDR31 THRU CDR35

| Per MIL-PRF-55681 (Metric Sizes) | AVX Style | Length (L) (mm) | Width (W) (mm) | Thickness (T) | | Termination Band (t) | |
|----------------------------------|-----------|-----------------|----------------|---------------|-----------|----------------------|-----------|
| | | | | Max. (mm) | Min. (mm) | Max. (mm) | Min. (mm) |
| CDR31 | 0805 | 2.00 | 1.25 | 1.3 | .50 | .70 | .30 |
| CDR32 | 1206 | 3.20 | 1.60 | 1.3 | — | .70 | .30 |
| CDR33 | 1210 | 3.20 | 2.50 | 1.5 | — | .70 | .30 |
| CDR34 | 1812 | 4.50 | 3.20 | 1.5 | — | .70 | .30 |
| CDR35 | 1825 | 4.50 | 6.40 | 1.5 | — | .70 | .30 |

MIL-PRF-55681/Chips



Military Part Number Identification CDR31

CDR31 to MIL-PRF-55681/7

| Military Type Designation 1/ | Capacitance in pF | Capacitance tolerance | Rated temperature and voltage-temperature limits | WVDC |
|----------------------------------|-------------------|-----------------------|--|------|
| AVX Style 0805/CDR31 (BP) | | | | |
| CDR31BP1R0B--- | 1.0 | B,C | BP | 100 |
| CDR31BP1R1B--- | 1.1 | B,C | BP | 100 |
| CDR31BP1R2B--- | 1.2 | B,C | BP | 100 |
| CDR31BP1R3B--- | 1.3 | B,C | BP | 100 |
| CDR31BP1R5B--- | 1.5 | B,C | BP | 100 |
| CDR31BP1R6B--- | 1.6 | B,C | BP | 100 |
| CDR31BP1R8B--- | 1.8 | B,C | BP | 100 |
| CDR31BP2R0B--- | 2.0 | B,C | BP | 100 |
| CDR31BP2R2B--- | 2.2 | B,C | BP | 100 |
| CDR31BP2R4B--- | 2.4 | B,C | BP | 100 |
| CDR31BP2R7B--- | 2.7 | B,C,D | BP | 100 |
| CDR31BP3R0B--- | 3.0 | B,C,D | BP | 100 |
| CDR31BP3R3B--- | 3.3 | B,C,D | BP | 100 |
| CDR31BP3R6B--- | 3.6 | B,C,D | BP | 100 |
| CDR31BP3R9B--- | 3.9 | B,C,D | BP | 100 |
| CDR31BP4R3B--- | 4.3 | B,C,D | BP | 100 |
| CDR31BP4R7B--- | 4.7 | B,C,D | BP | 100 |
| CDR31BP5R1B--- | 5.1 | B,C,D | BP | 100 |
| CDR31BP5R6B--- | 5.6 | B,C,D | BP | 100 |
| CDR31BP6R2B--- | 6.2 | B,C,D | BP | 100 |
| CDR31BP6R8B--- | 6.8 | B,C,D | BP | 100 |
| CDR31BP7R5B--- | 7.5 | B,C,D | BP | 100 |
| CDR31BP8R2B--- | 8.2 | B,C,D | BP | 100 |
| CDR31BP9R1B--- | 9.1 | B,C,D | BP | 100 |
| CDR31BP100B--- | 10 | F,J,K | BP | 100 |
| CDR31BP110B--- | 11 | F,J,K | BP | 100 |
| CDR31BP120B--- | 12 | F,J,K | BP | 100 |
| CDR31BP130B--- | 13 | F,J,K | BP | 100 |
| CDR31BP150B--- | 15 | F,J,K | BP | 100 |
| CDR31BP160B--- | 16 | F,J,K | BP | 100 |
| CDR31BP180B--- | 18 | F,J,K | BP | 100 |
| CDR31BP200B--- | 20 | F,J,K | BP | 100 |
| CDR31BP220B--- | 22 | F,J,K | BP | 100 |
| CDR31BP240B--- | 24 | F,J,K | BP | 100 |
| CDR31BP270B--- | 27 | F,J,K | BP | 100 |
| CDR31BP300B--- | 30 | F,J,K | BP | 100 |
| CDR31BP330B--- | 33 | F,J,K | BP | 100 |
| CDR31BP360B--- | 36 | F,J,K | BP | 100 |
| CDR31BP390B--- | 39 | F,J,K | BP | 100 |
| CDR31BP430B--- | 43 | F,J,K | BP | 100 |
| CDR31BP470B--- | 47 | F,J,K | BP | 100 |
| CDR31BP510B--- | 51 | F,J,K | BP | 100 |
| CDR31BP560B--- | 56 | F,J,K | BP | 100 |
| CDR31BP620B--- | 62 | F,J,K | BP | 100 |
| CDR31BP680B--- | 68 | F,J,K | BP | 100 |
| CDR31BP750B--- | 75 | F,J,K | BP | 100 |
| CDR31BP820B--- | 82 | F,J,K | BP | 100 |
| CDR31BP910B--- | 91 | F,J,K | BP | 100 |

- Add appropriate failure rate
- Add appropriate termination finish
- Capacitance Tolerance

| Military Type Designation 1/ | Capacitance in pF | Capacitance tolerance | Rated temperature and voltage-temperature limits | WVDC |
|---|-------------------|-----------------------|--|------|
| AVX Style 0805/CDR31 (BP) cont'd | | | | |
| CDR31BP101B--- | 100 | F,J,K | BP | 100 |
| CDR31BP111B--- | 110 | F,J,K | BP | 100 |
| CDR31BP121B--- | 120 | F,J,K | BP | 100 |
| CDR31BP131B--- | 130 | F,J,K | BP | 100 |
| CDR31BP151B--- | 150 | F,J,K | BP | 100 |
| CDR31BP161B--- | 160 | F,J,K | BP | 100 |
| CDR31BP181B--- | 180 | F,J,K | BP | 100 |
| CDR31BP201B--- | 200 | F,J,K | BP | 100 |
| CDR31BP221B--- | 220 | F,J,K | BP | 100 |
| CDR31BP241B--- | 240 | F,J,K | BP | 100 |
| CDR31BP271B--- | 270 | F,J,K | BP | 100 |
| CDR31BP301B--- | 300 | F,J,K | BP | 100 |
| CDR31BP331B--- | 330 | F,J,K | BP | 100 |
| CDR31BP361B--- | 360 | F,J,K | BP | 100 |
| CDR31BP391B--- | 390 | F,J,K | BP | 100 |
| CDR31BP431B--- | 430 | F,J,K | BP | 100 |
| CDR31BP471B--- | 470 | F,J,K | BP | 100 |
| CDR31BP511A--- | 510 | F,J,K | BP | 50 |
| CDR31BP561A--- | 560 | F,J,K | BP | 50 |
| CDR31BP621A--- | 620 | F,J,K | BP | 50 |
| CDR31BP681A--- | 680 | F,J,K | BP | 50 |
| AVX Style 0805/CDR31 (BX) | | | | |
| CDR31BX471B--- | 470 | K,M | BX | 100 |
| CDR31BX561B--- | 560 | K,M | BX | 100 |
| CDR31BX681B--- | 680 | K,M | BX | 100 |
| CDR31BX821B--- | 820 | K,M | BX | 100 |
| CDR31BX102B--- | 1,000 | K,M | BX | 100 |
| CDR31BX122B--- | 1,200 | K,M | BX | 100 |
| CDR31BX152B--- | 1,500 | K,M | BX | 100 |
| CDR31BX182B--- | 1,800 | K,M | BX | 100 |
| CDR31BX222B--- | 2,200 | K,M | BX | 100 |
| CDR31BX272B--- | 2,700 | K,M | BX | 100 |
| CDR31BX332B--- | 3,300 | K,M | BX | 100 |
| CDR31BX392B--- | 3,900 | K,M | BX | 100 |
| CDR31BX472B--- | 4,700 | K,M | BX | 100 |
| CDR31BX562A--- | 5,600 | K,M | BX | 50 |
| CDR31BX682A--- | 6,800 | K,M | BX | 50 |
| CDR31BX822A--- | 8,200 | K,M | BX | 50 |
| CDR31BX103A--- | 10,000 | K,M | BX | 50 |
| CDR31BX123A--- | 12,000 | K,M | BX | 50 |
| CDR31BX153A--- | 15,000 | K,M | BX | 50 |
| CDR31BX183A--- | 18,000 | K,M | BX | 50 |

- Add appropriate failure rate
- Add appropriate termination finish
- Capacitance Tolerance

1/ The complete part number will include additional symbols to indicate capacitance tolerance, termination and failure rate level.



MIL-PRF-55681/Chips



Military Part Number Identification CDR32

CDR32 to MIL-PRF-55681/8

| Military Type Designation 1/ | Capacitance in pF | Capacitance tolerance | Rated temperature and voltage-temperature limits | WVDC | Military Type Designation 1/ | Capacitance in pF | Capacitance tolerance | Rated temperature and voltage-temperature limits | WVDC |
|----------------------------------|-------------------|-----------------------|--|------|---|-------------------|-----------------------|--|------|
| AVX Style 1206/CDR32 (BP) | | | | | AVX Style 1206/CDR32 (BP) cont'd | | | | |
| CDR32BP1R0B--- | 1.0 | B,C | BP | 100 | CDR32BP101B--- | 100 | F,J,K | BP | 100 |
| CDR32BP1R1B--- | 1.1 | B,C | BP | 100 | CDR32BP111B--- | 110 | F,J,K | BP | 100 |
| CDR32BP1R2B--- | 1.2 | B,C | BP | 100 | CDR32BP121B--- | 120 | F,J,K | BP | 100 |
| CDR32BP1R3B--- | 1.3 | B,C | BP | 100 | CDR32BP131B--- | 130 | F,J,K | BP | 100 |
| CDR32BP1R5B--- | 1.5 | B,C | BP | 100 | CDR32BP151B--- | 150 | F,J,K | BP | 100 |
| CDR32BP1R6B--- | 1.6 | B,C | BP | 100 | CDR32BP161B--- | 160 | F,J,K | BP | 100 |
| CDR32BP1R8B--- | 1.8 | B,C | BP | 100 | CDR32BP181B--- | 180 | F,J,K | BP | 100 |
| CDR32BP2R0B--- | 2.0 | B,C | BP | 100 | CDR32BP201B--- | 200 | F,J,K | BP | 100 |
| CDR32BP2R2B--- | 2.2 | B,C | BP | 100 | CDR32BP221B--- | 220 | F,J,K | BP | 100 |
| CDR32BP2R4B--- | 2.4 | B,C | BP | 100 | CDR32BP241B--- | 240 | F,J,K | BP | 100 |
| CDR32BP2R7B--- | 2.7 | B,C,D | BP | 100 | CDR32BP271B--- | 270 | F,J,K | BP | 100 |
| CDR32BP3R0B--- | 3.0 | B,C,D | BP | 100 | CDR32BP301B--- | 300 | F,J,K | BP | 100 |
| CDR32BP3R3B--- | 3.3 | B,C,D | BP | 100 | CDR32BP331B--- | 330 | F,J,K | BP | 100 |
| CDR32BP3R6B--- | 3.6 | B,C,D | BP | 100 | CDR32BP361B--- | 360 | F,J,K | BP | 100 |
| CDR32BP3R9B--- | 3.9 | B,C,D | BP | 100 | CDR32BP391B--- | 390 | F,J,K | BP | 100 |
| CDR32BP4R3B--- | 4.3 | B,C,D | BP | 100 | CDR32BP431B--- | 430 | F,J,K | BP | 100 |
| CDR32BP4R7B--- | 4.7 | B,C,D | BP | 100 | CDR32BP471B--- | 470 | F,J,K | BP | 100 |
| CDR32BP5R1B--- | 5.1 | B,C,D | BP | 100 | CDR32BP511B--- | 510 | F,J,K | BP | 100 |
| CDR32BP5R6B--- | 5.6 | B,C,D | BP | 100 | CDR32BP561B--- | 560 | F,J,K | BP | 100 |
| CDR32BP6R2B--- | 6.2 | B,C,D | BP | 100 | CDR32BP621B--- | 620 | F,J,K | BP | 100 |
| CDR32BP6R8B--- | 6.8 | B,C,D | BP | 100 | CDR32BP681B--- | 680 | F,J,K | BP | 100 |
| CDR32BP7R5B--- | 7.5 | B,C,D | BP | 100 | CDR32BP751B--- | 750 | F,J,K | BP | 100 |
| CDR32BP8R2B--- | 8.2 | B,C,D | BP | 100 | CDR32BP821B--- | 820 | F,J,K | BP | 100 |
| CDR32BP9R1B--- | 9.1 | B,C,D | BP | 100 | CDR32BP911B--- | 910 | F,J,K | BP | 100 |
| CDR32BP100B--- | 10 | F,J,K | BP | 100 | CDR32BP102B--- | 1,000 | F,J,K | BP | 100 |
| CDR32BP110B--- | 11 | F,J,K | BP | 100 | CDR32BP112A--- | 1,100 | F,J,K | BP | 50 |
| CDR32BP120B--- | 12 | F,J,K | BP | 100 | CDR32BP122A--- | 1,200 | F,J,K | BP | 50 |
| CDR32BP130B--- | 13 | F,J,K | BP | 100 | CDR32BP132A--- | 1,300 | F,J,K | BP | 50 |
| CDR32BP150B--- | 15 | F,J,K | BP | 100 | CDR32BP152A--- | 1,500 | F,J,K | BP | 50 |
| CDR32BP160B--- | 16 | F,J,K | BP | 100 | CDR32BP162A--- | 1,600 | F,J,K | BP | 50 |
| CDR32BP180B--- | 18 | F,J,K | BP | 100 | CDR32BP182A--- | 1,800 | F,J,K | BP | 50 |
| CDR32BP200B--- | 20 | F,J,K | BP | 100 | CDR32BP202A--- | 2,000 | F,J,K | BP | 50 |
| CDR32BP220B--- | 22 | F,J,K | BP | 100 | CDR32BP222A--- | 2,200 | F,J,K | BP | 50 |
| CDR32BP240B--- | 24 | F,J,K | BP | 100 | AVX Style 1206/CDR32 (BX) | | | | |
| CDR32BP270B--- | 27 | F,J,K | BP | 100 | CDR32BX472B--- | 4,700 | K,M | BX | 100 |
| CDR32BP300B--- | 30 | F,J,K | BP | 100 | CDR32BX562B--- | 5,600 | K,M | BX | 100 |
| CDR32BP330B--- | 33 | F,J,K | BP | 100 | CDR32BX682B--- | 6,800 | K,M | BX | 100 |
| CDR32BP360B--- | 36 | F,J,K | BP | 100 | CDR32BX822B--- | 8,200 | K,M | BX | 100 |
| CDR32BP390B--- | 39 | F,J,K | BP | 100 | CDR32BX103B--- | 10,000 | K,M | BX | 100 |
| CDR32BP430B--- | 43 | F,J,K | BP | 100 | CDR32BX123B--- | 12,000 | K,M | BX | 100 |
| CDR32BP470B--- | 47 | F,J,K | BP | 100 | CDR32BX153B--- | 15,000 | K,M | BX | 100 |
| CDR32BP510B--- | 51 | F,J,K | BP | 100 | CDR32BX183A--- | 18,000 | K,M | BX | 50 |
| CDR32BP560B--- | 56 | F,J,K | BP | 100 | CDR32BX223A--- | 22,000 | K,M | BX | 50 |
| CDR32BP620B--- | 62 | F,J,K | BP | 100 | CDR32BX273A--- | 27,000 | K,M | BX | 50 |
| CDR32BP680B--- | 68 | F,J,K | BP | 100 | CDR32BX333A--- | 33,000 | K,M | BX | 50 |
| CDR32BP750B--- | 75 | F,J,K | BP | 100 | CDR32BX393A--- | 39,000 | K,M | BX | 50 |
| CDR32BP820B--- | 82 | F,J,K | BP | 100 | | | | | |
| CDR32BP910B--- | 91 | F,J,K | BP | 100 | | | | | |

— Add appropriate failure rate
 — Add appropriate termination finish
 — Capacitance Tolerance

— Add appropriate failure rate
 — Add appropriate termination finish
 — Capacitance Tolerance

1/ The complete part number will include additional symbols to indicate capacitance tolerance, termination and failure rate level.

MIL-PRF-55681/Chips



Military Part Number Identification CDR33/34/35

CDR33/34/35 to MIL-PRF-55681/9/10/11

| Military Type Designation 1/ | Capacitance in pF | Capacitance tolerance | Rated temperature and voltage-temperature limits | WVDC |
|----------------------------------|-------------------|-----------------------|--|------|
| AVX Style 1210/CDR33 (BP) | | | | |
| CDR33BP102B--- | 1,000 | F,J,K | BP | 100 |
| CDR33BP112B--- | 1,100 | F,J,K | BP | 100 |
| CDR33BP122B--- | 1,200 | F,J,K | BP | 100 |
| CDR33BP132B--- | 1,300 | F,J,K | BP | 100 |
| CDR33BP152B--- | 1,500 | F,J,K | BP | 100 |
| CDR33BP162B--- | 1,600 | F,J,K | BP | 100 |
| CDR33BP182B--- | 1,800 | F,J,K | BP | 100 |
| CDR33BP202B--- | 2,000 | F,J,K | BP | 100 |
| CDR33BP222B--- | 2,200 | F,J,K | BP | 100 |
| CDR33BP242A--- | 2,400 | F,J,K | BP | 50 |
| CDR33BP272A--- | 2,700 | F,J,K | BP | 50 |
| CDR33BP302A--- | 3,000 | F,J,K | BP | 50 |
| CDR33BP332A--- | 3,300 | F,J,K | BP | 50 |
| AVX Style 1210/CDR33 (BX) | | | | |
| CDR33BX153B--- | 15,000 | K,M | BX | 100 |
| CDR33BX183B--- | 18,000 | K,M | BX | 100 |
| CDR33BX223B--- | 22,000 | K,M | BX | 100 |
| CDR33BX273B--- | 27,000 | K,M | BX | 100 |
| CDR33BX393A--- | 39,000 | K,M | BX | 50 |
| CDR33BX473A--- | 47,000 | K,M | BX | 50 |
| CDR33BX563A--- | 56,000 | K,M | BX | 50 |
| CDR33BX683A--- | 68,000 | K,M | BX | 50 |
| CDR33BX823A--- | 82,000 | K,M | BX | 50 |
| CDR33BX104A--- | 100,000 | K,M | BX | 50 |
| AVX Style 1812/CDR34 (BP) | | | | |
| CDR34BP222B--- | 2,200 | F,J,K | BP | 100 |
| CDR34BP242B--- | 2,400 | F,J,K | BP | 100 |
| CDR34BP272B--- | 2,700 | F,J,K | BP | 100 |
| CDR34BP302B--- | 3,000 | F,J,K | BP | 100 |
| CDR34BP332B--- | 3,300 | F,J,K | BP | 100 |
| CDR34BP362B--- | 3,600 | F,J,K | BP | 100 |
| CDR34BP392B--- | 3,900 | F,J,K | BP | 100 |
| CDR34BP432B--- | 4,300 | F,J,K | BP | 100 |
| CDR34BP472B--- | 4,700 | F,J,K | BP | 100 |
| CDR34BP512A--- | 5,100 | F,J,K | BP | 50 |
| CDR34BP562A--- | 5,600 | F,J,K | BP | 50 |
| CDR34BP622A--- | 6,200 | F,J,K | BP | 50 |
| CDR34BP682A--- | 6,800 | F,J,K | BP | 50 |
| CDR34BP752A--- | 7,500 | F,J,K | BP | 50 |
| CDR34BP822A--- | 8,200 | F,J,K | BP | 50 |
| CDR34BP912A--- | 9,100 | F,J,K | BP | 50 |
| CDR34BP103A--- | 10,000 | F,J,K | BP | 50 |

- Add appropriate failure rate
- Add appropriate termination finish
- Capacitance Tolerance

| Military Type Designation 1/ | Capacitance in pF | Capacitance tolerance | Rated temperature and voltage-temperature limits | WVDC |
|----------------------------------|-------------------|-----------------------|--|------|
| AVX Style 1812/CDR34 (BX) | | | | |
| CDR34BX273B--- | 27,000 | K,M | BX | 100 |
| CDR34BX333B--- | 33,000 | K,M | BX | 100 |
| CDR34BX393B--- | 39,000 | K,M | BX | 100 |
| CDR34BX473B--- | 47,000 | K,M | BX | 100 |
| CDR34BX563B--- | 56,000 | K,M | BX | 100 |
| CDR34BX104A--- | 100,000 | K,M | BX | 50 |
| CDR34BX124A--- | 120,000 | K,M | BX | 50 |
| CDR34BX154A--- | 150,000 | K,M | BX | 50 |
| CDR34BX184A--- | 180,000 | K,M | BX | 50 |
| AVX Style 1825/CDR35 (BP) | | | | |
| CDR35BP472B--- | 4,700 | F,J,K | BP | 100 |
| CDR35BP512B--- | 5,100 | F,J,K | BP | 100 |
| CDR35BP562B--- | 5,600 | F,J,K | BP | 100 |
| CDR35BP622B--- | 6,200 | F,J,K | BP | 100 |
| CDR35BP682B--- | 6,800 | F,J,K | BP | 100 |
| CDR35BP752B--- | 7,500 | F,J,K | BP | 100 |
| CDR35BP822B--- | 8,200 | F,J,K | BP | 100 |
| CDR35BP912B--- | 9,100 | F,J,K | BP | 100 |
| CDR35BP103B--- | 10,000 | F,J,K | BP | 100 |
| CDR35BP113A--- | 11,000 | F,J,K | BP | 50 |
| CDR35BP123A--- | 12,000 | F,J,K | BP | 50 |
| CDR35BP133A--- | 13,000 | F,J,K | BP | 50 |
| CDR35BP153A--- | 15,000 | F,J,K | BP | 50 |
| CDR35BP163A--- | 16,000 | F,J,K | BP | 50 |
| CDR35BP183A--- | 18,000 | F,J,K | BP | 50 |
| CDR35BP203A--- | 20,000 | F,J,K | BP | 50 |
| CDR35BP223A--- | 22,000 | F,J,K | BP | 50 |
| AVX Style 1825/CDR35 (BX) | | | | |
| CDR35BX563B--- | 56,000 | K,M | BX | 100 |
| CDR35BX683B--- | 68,000 | K,M | BX | 100 |
| CDR35BX823B--- | 82,000 | K,M | BX | 100 |
| CDR35BX104B--- | 100,000 | K,M | BX | 100 |
| CDR35BX124B--- | 120,000 | K,M | BX | 100 |
| CDR35BX154B--- | 150,000 | K,M | BX | 100 |
| CDR35BX184A--- | 180,000 | K,M | BX | 50 |
| CDR35BX224A--- | 220,000 | K,M | BX | 50 |
| CDR35BX274A--- | 270,000 | K,M | BX | 50 |
| CDR35BX334A--- | 330,000 | K,M | BX | 50 |
| CDR35BX394A--- | 390,000 | K,M | BX | 50 |
| CDR35BX474A--- | 470,000 | K,M | BX | 50 |

- Add appropriate failure rate
- Add appropriate termination finish
- Capacitance Tolerance

1/ The complete part number will include additional symbols to indicate capacitance tolerance, termination and failure rate level.



Packaging of Chip Components



Automatic Insertion Packaging

TAPE & REEL QUANTITIES

All tape and reel specifications are in compliance with RS481.

| | 8mm | 12mm | |
|---------------------------|---|--------|--|
| Paper or Embossed Carrier | 0612, 0508, 0805, 1206, 1210 | | |
| Embossed Only | | 1808 | 1812, 1825 2220, 2225 |
| Paper Only | 0201, 0306, 0402, 0603 | | |
| Qty. per Reel/7" Reel | 2,000, 3,000 or 4,000, 10,000, 15,000 Contact factory for exact quantity | 3,000 | 500, 1,000 Contact factory for exact quantity |
| Qty. per Reel/13" Reel | 5,000, 10,000, 50,000 Contact factory for exact quantity | 10,000 | 4,000 |

REEL DIMENSIONS

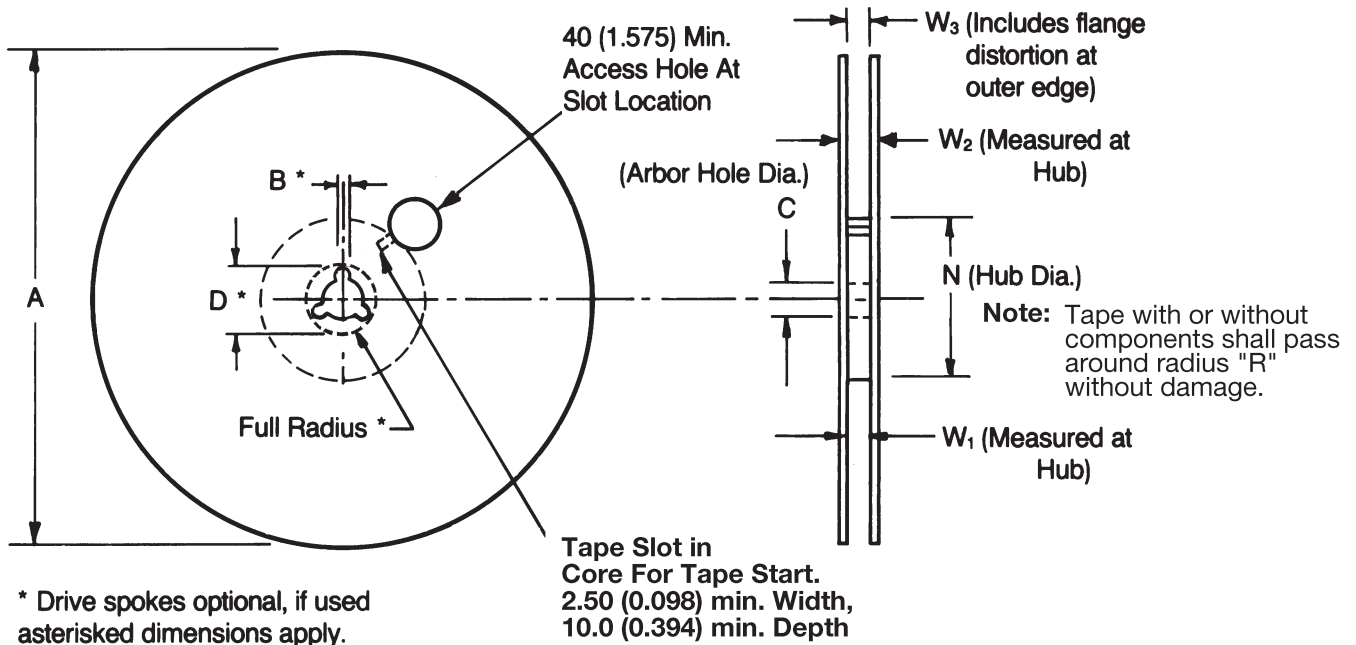

| Tape Size ⁽¹⁾ | A Max. | B* Min. | C | D* Min. | N Min. | W ₁ | W ₂ Max. | W ₃ |
|--------------------------|-----------------|----------------|--|-----------------|-----------------|--|---------------------|----------------------|
| 8mm | 330 (12.992) | 1.5 (0.059) | 13.0 ^{+0.50} _{-0.20} (0.512 ^{+0.020} _{-0.008}) | 20.2 (0.795) | 50.0 (1.969) | 8.40 ^{+1.5} _{-0.6} (0.331 ^{+0.059} _{-0.0}) | 14.4 (0.567) | 7.90 Min. (0.311) |
| 12mm | | | | | | 12.4 ^{+2.0} _{-0.0} (0.488 ^{+0.079} _{-0.0}) | | 11.9 Min. (0.469) |
| | | | | | | | | 10.9 Max. (0.429) |
| | | | | | | | | 15.4 Max. (0.607) |

Metric dimensions will govern.

English measurements rounded and for reference only.

(1) For tape sizes 16mm and 24mm (used with chip size 3640) consult EIA RS-481 latest revision.



Embossed Carrier Configuration



8 & 12mm Tape Only

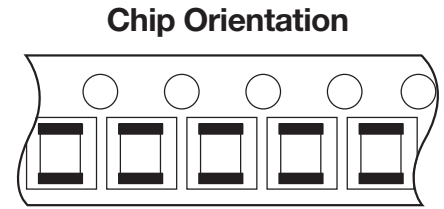
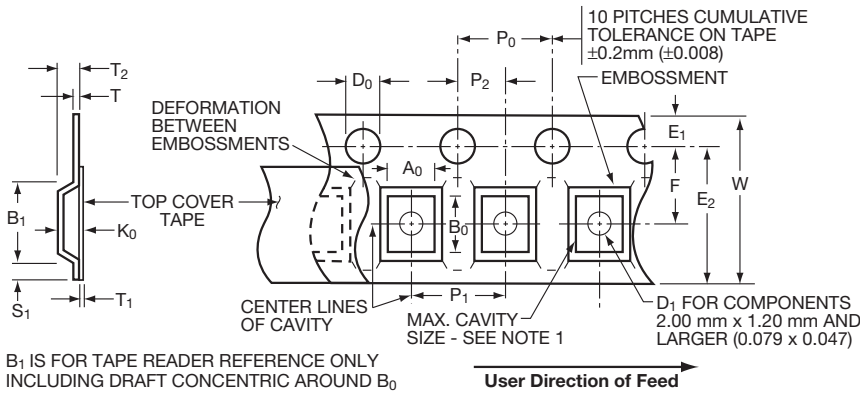

8 & 12mm Embossed Tape Metric Dimensions Will Govern

CONSTANT DIMENSIONS

| Tape Size | D ₀ | E | P ₀ | P ₂ | S ₁ Min. | T Max. | T ₁ |
|--------------|---|--------------------------------|-------------------------------|-------------------------------|---------------------|-----------------|-------------------------|
| 8mm and 12mm | 1.50 ^{+0.10} / _{0.0} (0.059 ^{+0.004} / _{0.0}) | 1.75 ± 0.10 (0.069 ± 0.004) | 4.0 ± 0.10 (0.157 ± 0.004) | 2.0 ± 0.05 (0.079 ± 0.002) | 0.60 (0.024) | 0.60 (0.024) | 0.10 (0.004) Max. |

VARIABLE DIMENSIONS

| Tape Size | B ₁ Max. | D ₁ Min. | E ₂ Min. | F | P ₁ See Note 5 | R Min. See Note 2 | T ₂ | W Max. | A ₀ B ₀ K ₀ |
|----------------------|---------------------|---------------------|---------------------|--------------------------------|--------------------------------|----------------------|----------------------|-----------------|--|
| 8mm | 4.35 (0.171) | 1.00 (0.039) | 6.25 (0.246) | 3.50 ± 0.05 (0.138 ± 0.002) | 4.00 ± 0.10 (0.157 ± 0.004) | 25.0 (0.984) | 2.50 Max. (0.098) | 8.30 (0.327) | See Note 1 |
| 12mm | 8.20 (0.323) | 1.50 (0.059) | 10.25 (0.404) | 5.50 ± 0.05 (0.217 ± 0.002) | 4.00 ± 0.10 (0.157 ± 0.004) | 30.0 (1.181) | 6.50 Max. (0.256) | 12.3 (0.484) | See Note 1 |
| 8mm 1/2 Pitch | 4.35 (0.171) | 1.00 (0.039) | 6.25 (0.246) | 3.50 ± 0.05 (0.138 ± 0.002) | 2.00 ± 0.10 (0.079 ± 0.004) | 25.0 (0.984) | 2.50 Max. (0.098) | 8.30 (0.327) | See Note 1 |
| 12mm Double Pitch | 8.20 (0.323) | 1.50 (0.059) | 10.25 (0.404) | 5.50 ± 0.05 (0.217 ± 0.002) | 8.00 ± 0.10 (0.315 ± 0.004) | 30.0 (1.181) | 6.50 Max. (0.256) | 12.3 (0.484) | See Note 1 |

NOTES:

1. The cavity defined by A₀, B₀, and K₀ shall be configured to provide the following:

- Surround the component with sufficient clearance such that:
 - a) the component does not protrude beyond the sealing plane of the cover tape.
 - b) the component can be removed from the cavity in a vertical direction without mechanical restriction, after the cover tape has been removed.
 - c) rotation of the component is limited to 20° maximum (see Sketches D & E).
 - d) lateral movement of the component is restricted to 0.5mm maximum (see Sketch F).

2. Tape with or without components shall pass around radius "R" without damage.

3. Bar code labeling (if required) shall be on the side of the reel opposite the round sprocket holes. Refer to EIA-556.

4. B₁ dimension is a reference dimension for tape feeder clearance only.

5. If P₁ = 2.0mm, the tape may not properly index in all tape feeders.

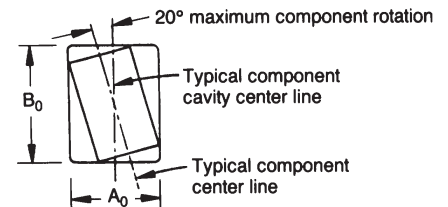
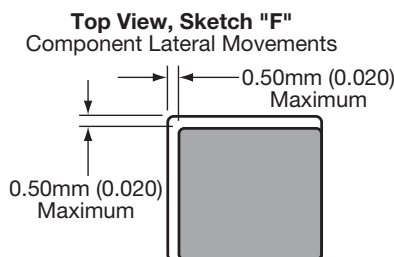
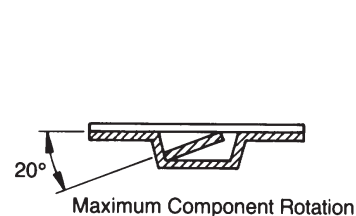

Paper Carrier Configuration



8 & 12mm Tape Only

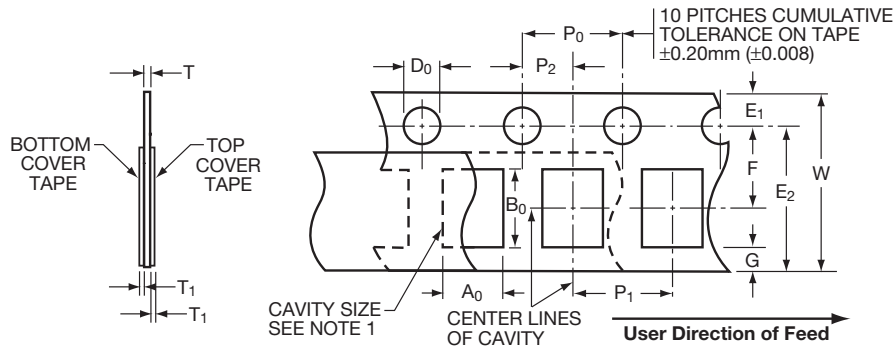

8 & 12mm Paper Tape Metric Dimensions Will Govern

CONSTANT DIMENSIONS

| Tape Size | D ₀ | E | P ₀ | P ₂ | T ₁ | G. Min. | R Min. |
|--------------|---|--------------------------------|--------------------------------|--------------------------------|-------------------------|-------------------------|------------------------------------|
| 8mm and 12mm | 1.50 ^{+0.10} _{-0.004} (0.059 ^{+0.004} _{-0.004}) | 1.75 ± 0.10 (0.069 ± 0.004) | 4.00 ± 0.10 (0.157 ± 0.004) | 2.00 ± 0.05 (0.079 ± 0.002) | 0.10 (0.004) Max. | 0.75 (0.030) Min. | 25.0 (0.984) See Note 2 Min. |

VARIABLE DIMENSIONS

| Tape Size | P ₁ See Note 4 | E ₂ Min. | F | W | A ₀ B ₀ | T |
|-------------------------|---------------------------------|---------------------|--------------------------------|--|-------------------------------|--|
| 8mm | 4.00 ± 0.10 (0.157 ± 0.004) | 6.25 (0.246) | 3.50 ± 0.05 (0.138 ± 0.002) | 8.00 ^{+0.30} _{-0.10} (0.315 ^{+0.012} _{-0.004}) | See Note 1 | 1.10mm (0.043) Max. for Paper Base Tape and 1.60mm (0.063) Max. for Non-Paper Base Compositions |
| 12mm | 4.00 ± 0.010 (0.157 ± 0.004) | 10.25 (0.404) | 5.50 ± 0.05 (0.217 ± 0.002) | 12.0 ± 0.30 (0.472 ± 0.012) | | |
| 8mm 1/2 Pitch | 2.00 ± 0.05 (0.079 ± 0.002) | 6.25 (0.246) | 3.50 ± 0.05 (0.138 ± 0.002) | 8.00 ^{+0.30} _{-0.10} (0.315 ^{+0.012} _{-0.004}) | | |
| 12mm Double Pitch | 8.00 ± 0.10 (0.315 ± 0.004) | 10.25 (0.404) | 5.50 ± 0.05 (0.217 ± 0.002) | 12.0 ± 0.30 (0.472 ± 0.012) | | |

NOTES:

- The cavity defined by A₀, B₀, and T shall be configured to provide sufficient clearance surrounding the component so that:
 - the component does not protrude beyond either surface of the carrier tape;
 - the component can be removed from the cavity in a vertical direction without mechanical restriction after the top cover tape has been removed;
 - rotation of the component is limited to 20° maximum (see Sketches A & B);
 - lateral movement of the component is restricted to 0.5mm maximum (see Sketch C).
- Tape with or without components shall pass around radius "R" without damage.
- Bar code labeling (if required) shall be on the side of the reel opposite the sprocket holes. Refer to EIA-556.
- If P₁ = 2.0mm, the tape may not properly index in all tape feeders.

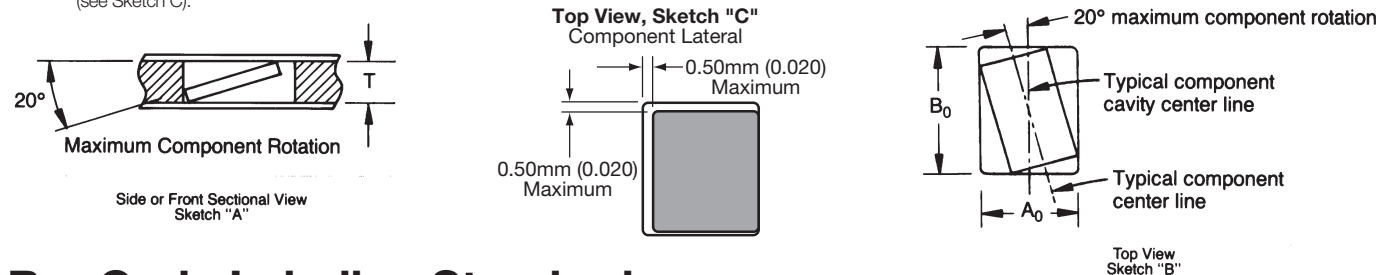

Bar Code Labeling Standard

AVX bar code labeling is available and follows latest version of EIA-556



BENEFITS

- Easier handling
- Smaller packaging volume
(1/20 of T/R packaging)
- Easier inventory control
- Flexibility
- Recyclable

CASE DIMENSIONS

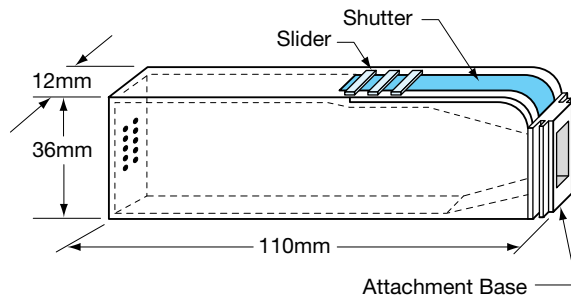

BULK FEEDER

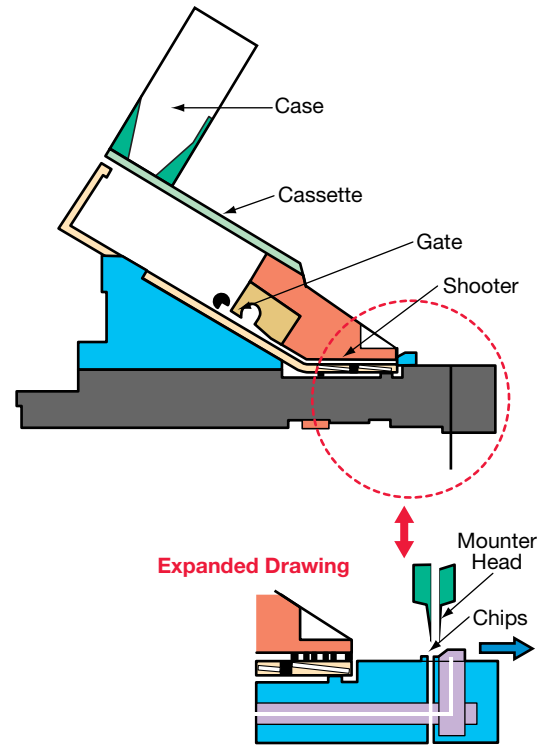

CASE QUANTITIES

| Part Size | 0402 | 0603 | 0805 | 1206 |
|--------------------------|--------|--------|--|---|
| Qty. (pcs / cassette) | 80,000 | 15,000 | 10,000 (T=.023") 8,000 (T=.031") 6,000 (T=.043") | 5,000 (T=.023") 4,000 (T=.032") 3,000 (T=.044") |

I. Capacitance (farads)

English: $C = \frac{.224 \text{ K A}}{T_D}$

Metric: $C = \frac{.0884 \text{ K A}}{T_D}$

II. Energy stored in capacitors (Joules, watt - sec)

$E = \frac{1}{2} CV^2$

III. Linear charge of a capacitor (Amperes)

$I = C \frac{dV}{dt}$

IV. Total Impedance of a capacitor (ohms)

$Z = \sqrt{R_S^2 + (X_C - X_L)^2}$

V. Capacitive Reactance (ohms)

$X_C = \frac{1}{2 \pi fC}$

VI. Inductive Reactance (ohms)

$X_L = 2 \pi fL$

VII. Phase Angles:

Ideal Capacitors: Current leads voltage 90°

Ideal Inductors: Current lags voltage 90°

Ideal Resistors: Current in phase with voltage

VIII. Dissipation Factor (%)

D.F. = $\tan \delta$ (loss angle) = $\frac{E.S.R.}{X_C} = (2 \pi fC) (E.S.R.)$

IX. Power Factor (%)

P.F. = $\text{Sine } \delta$ (loss angle) = $\text{Cos } \phi$ (phase angle)

P.F. = (when less than 10%) = DF

X. Quality Factor (dimensionless)

$Q = \text{Cotan } \delta$ (loss angle) = $\frac{1}{D.F.}$

XI. Equivalent Series Resistance (ohms)

E.S.R. = (D.F.) (Xc) = (D.F.) / (2 π fC)

XII. Power Loss (watts)

Power Loss = (2 π fCV²) (D.F.)

XIII. KVA (Kilowatts)

KVA = 2 π fCV² x 10⁻³

XIV. Temperature Characteristic (ppm/°C)

T.C. = $\frac{C_t - C_{25}}{C_{25} (T_t - 25)} \times 10^6$

XV. Cap Drift (%)

C.D. = $\frac{C_1 - C_2}{C_1} \times 100$

XVI. Reliability of Ceramic Capacitors

$L_t = \left(\frac{V_t}{V_o} \right)^X \left(\frac{T_t}{T_o} \right)^Y$

XVII. Capacitors in Series (current the same)

Any Number: $\frac{1}{C_T} = \frac{1}{C_1} + \frac{1}{C_2} \dots \frac{1}{C_N}$

Two: $C_T = \frac{C_1 C_2}{C_1 + C_2}$

XVIII. Capacitors in Parallel (voltage the same)

$C_T = C_1 + C_2 \dots + C_N$

XIX. Aging Rate

A.R. = %Δ C/decade of time

XX. Decibels

db = 20 log $\frac{V_1}{V_2}$

METRIC PREFIXES

SYMBOLS

| | | | | | | | |
|-------|---------------------|----------------|------------------------|----------------|--|----------------|-------------------------|
| Pico | X 10 ⁻¹² | K | = Dielectric Constant | f | = frequency | L _t | = Test life |
| Nano | X 10 ⁻⁹ | A | = Area | L | = Inductance | V _t | = Test voltage |
| Micro | X 10 ⁻⁶ | T _D | = Dielectric thickness | δ | = Loss angle | V _o | = Operating voltage |
| Milli | X 10 ⁻³ | V | = Voltage | φ | = Phase angle | T _t | = Test temperature |
| Deci | X 10 ⁻¹ | t | = time | X & Y | = exponent effect of voltage and temp. | T _o | = Operating temperature |
| Deca | X 10 ⁺¹ | R _S | = Series Resistance | L _o | = Operating life | | |
| Deca | X 10 ⁺¹ | | | | | | |
| Kilo | X 10 ⁺³ | | | | | | |
| Mega | X 10 ⁺⁶ | | | | | | |
| Giga | X 10 ⁺⁹ | | | | | | |
| Tera | X 10 ⁺¹² | | | | | | |

Basic Construction – A multilayer ceramic (MLC) capacitor is a monolithic block of ceramic containing two sets of offset, interleaved planar electrodes that extend to two opposite surfaces of the ceramic dielectric. This simple

structure requires a considerable amount of sophistication, both in material and manufacture, to produce it in the quality and quantities needed in today's electronic equipment.

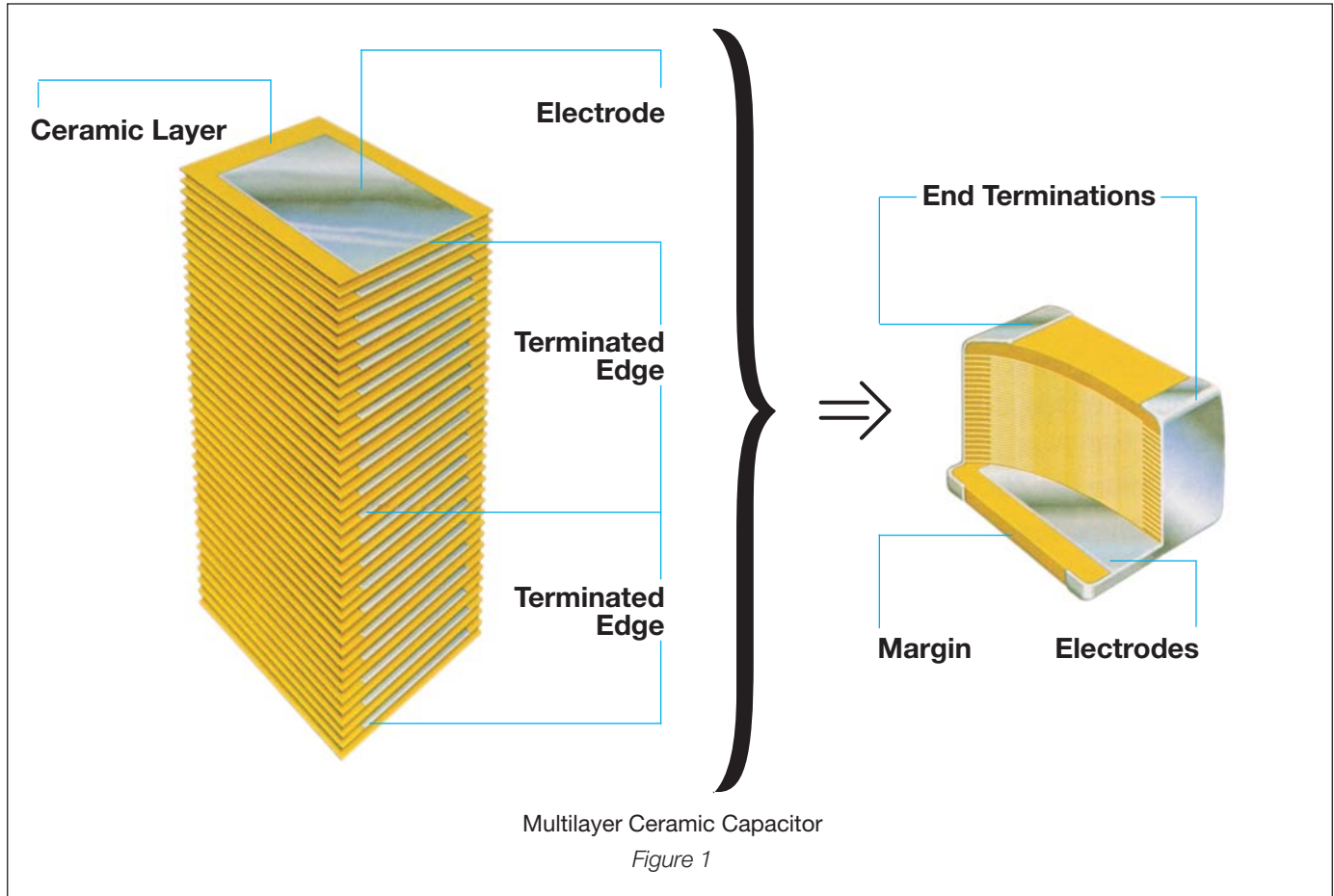

Formulations – Multilayer ceramic capacitors are available in both Class 1 and Class 2 formulations. Temperature compensating formulations are Class 1 and temperature stable and general application formulations are classified as Class 2.

Class 1 – Class 1 capacitors or temperature compensating capacitors are usually made from mixtures of titanates where barium titanate is normally not a major part of the mix. They have predictable temperature coefficients and in general, do not have an aging characteristic. Thus they are the most stable capacitor available. The most popular Class 1 multilayer ceramic capacitors are C0G (NP0) temperature compensating capacitors (negative-positive 0 ppm/°C).

Class 2 – EIA Class 2 capacitors typically are based on the chemistry of barium titanate and provide a wide range of capacitance values and temperature stability. The most commonly used Class 2 dielectrics are X7R and Y5V. The X7R provides intermediate capacitance values which vary only $\pm 15\%$ over the temperature range of -55°C to 125°C . It finds applications where stability over a wide temperature range is required.

The Y5V provides the highest capacitance values and is used in applications where limited temperature changes are expected. The capacitance value for Y5V can vary from 22% to -82% over the -30°C to 85°C temperature range.

All Class 2 capacitors vary in capacitance value under the influence of temperature, operating voltage (both AC and DC), and frequency. For additional information on performance changes with operating conditions, consult AVX's software, SpiCap.

Table 1: EIA and MIL Temperature Stable and General Application Codes

| EIA CODE | |
|---|--------------------------------|
| Percent Capacity Change Over Temperature Range | |
| RS198 | Temperature Range |
| X7 | -55°C to +125°C |
| X6 | -55°C to +105°C |
| X5 | -55°C to +85°C |
| Y5 | -30°C to +85°C |
| Z5 | +10°C to +85°C |
| Code | Percent Capacity Change |
| D | ±3.3% |
| E | ±4.7% |
| F | ±7.5% |
| P | ±10% |
| R | ±15% |
| S | ±22% |
| T | +22%, -33% |
| U | +22%, -56% |
| V | +22%, -82% |

EXAMPLE – A capacitor is desired with the capacitance value at 25°C to increase no more than 7.5% or decrease no more than 7.5% from -30°C to +85°C. EIA Code will be Y5F.

| MIL CODE | | |
|-----------------|-------------------------------|--------------------------------|
| Symbol | Temperature Range | |
| A | -55°C to +85°C | |
| B | -55°C to +125°C | |
| C | -55°C to +150°C | |
| Symbol | Cap. Change Zero Volts | Cap. Change Rated Volts |
| R | +15%, -15% | +15%, -40% |
| S | +22%, -22% | +22%, -56% |
| W | +22%, -56% | +22%, -66% |
| X | +15%, -15% | +15%, -25% |
| Y | +30%, -70% | +30%, -80% |
| Z | +20%, -20% | +20%, -30% |

Temperature characteristic is specified by combining range and change symbols, for example BR or AW. Specification slash sheets indicate the characteristic applicable to a given style of capacitor.

In specifying capacitance change with temperature for Class 2 materials, EIA expresses the capacitance change over an operating temperature range by a 3 symbol code. The first symbol represents the cold temperature end of the temperature range, the second represents the upper limit of the operating temperature range and the third symbol represents the capacitance change allowed over the operating temperature range. Table 1 provides a detailed explanation of the EIA system.

Effects of Voltage – Variations in voltage have little effect on Class 1 dielectric but does affect the capacitance and dissipation factor of Class 2 dielectrics. The application of DC voltage reduces both the capacitance and dissipation factor while the application of an AC voltage within a reasonable range tends to increase both capacitance and dissipation factor readings. If a high enough AC voltage is applied, eventually it will reduce capacitance just as a DC voltage will. Figure 2 shows the effects of AC voltage.

**Cap. Change vs. A.C. Volts
X7R**

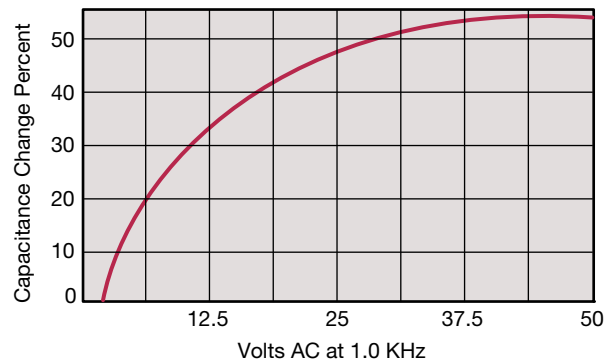

Figure 2

Capacitor specifications specify the AC voltage at which to measure (normally 0.5 or 1 VAC) and application of the wrong voltage can cause spurious readings. Figure 3 gives the voltage coefficient of dissipation factor for various AC voltages at 1 kilohertz. Applications of different frequencies will affect the percentage changes versus voltages.

**D.F. vs. A.C. Measurement Volts
X7R**

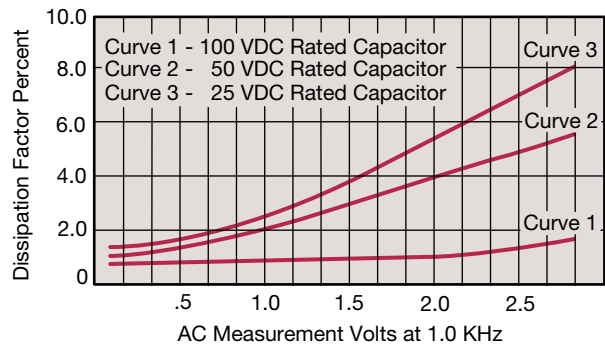

Figure 3

Typical effect of the application of DC voltage is shown in Figure 4. The voltage coefficient is more pronounced for higher K dielectrics. These figures are shown for room temperature conditions. The combination characteristic known as voltage temperature limits which shows the effects of rated voltage over the operating temperature range is shown in Figure 5 for the military BX characteristic.

**Typical Cap. Change vs. D.C. Volts
X7R**

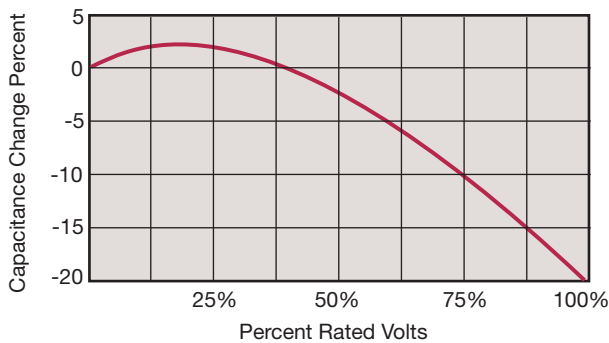

Figure 4

**Typical Cap. Change vs. Temperature
X7R**

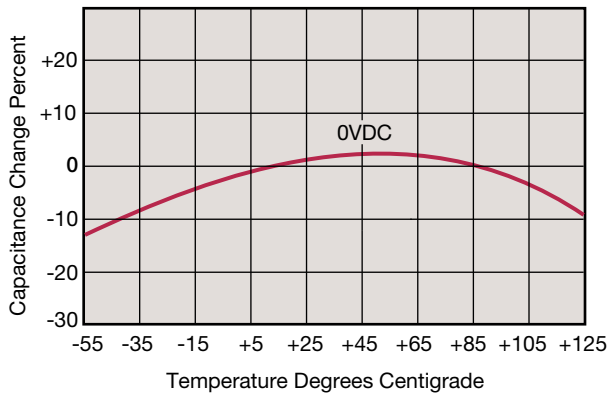

Figure 5

Effects of Time – Class 2 ceramic capacitors change capacitance and dissipation factor with time as well as temperature, voltage and frequency. This change with time is known as aging. Aging is caused by a gradual re-alignment of the crystalline structure of the ceramic and produces an exponential loss in capacitance and decrease in dissipation factor versus time. A typical curve of aging rate for semistable ceramics is shown in Figure 6.

If a Class 2 ceramic capacitor that has been sitting on the shelf for a period of time, is heated above its curie point, (125°C for 4 hours or 150°C for ½ hour will suffice) the part will de-age and return to its initial capacitance and dissipation factor readings. Because the capacitance changes rapidly, immediately after de-aging, the basic capacitance measurements are normally referred to a time period sometime after the de-aging process. Various manufacturers use different time bases but the most popular one is one day or twenty-four hours after “last heat.” Change in the aging curve can be caused by the application of voltage and other stresses. The possible changes in capacitance due to de-aging by heating the unit explain why capacitance changes are allowed after test, such as temperature cycling, moisture resistance, etc., in MIL specs. The application of high voltages such as dielectric withstanding voltages also tends to de-age

capacitors and is why re-reading of capacitance after 12 or 24 hours is allowed in military specifications after dielectric strength tests have been performed.

**Typical Curve of Aging Rate
X7R**

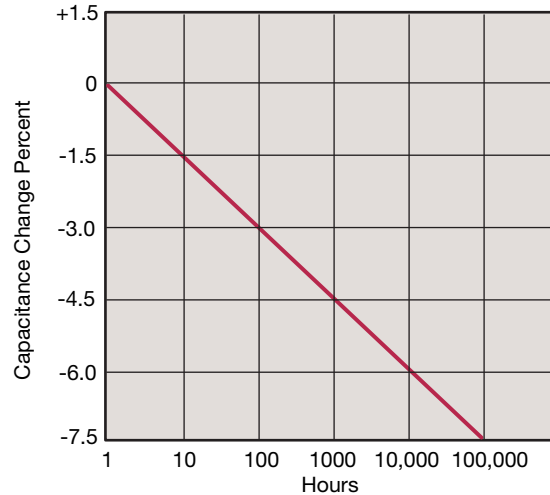

| Characteristic | Max. Aging Rate %/Decade |
|----------------|--------------------------|
| C0G (NP0) | None |
| X7R, X5R | 2 |
| Y5V | 7 |

Figure 6

Effects of Frequency – Frequency affects capacitance and impedance characteristics of capacitors. This effect is much more pronounced in high dielectric constant ceramic formulation than in low K formulations. AVX's SpiCap software generates impedance, ESR, series inductance, series resonant frequency and capacitance all as functions of frequency, temperature and DC bias for standard chip sizes and styles. It is available free from AVX and can be downloaded for free from AVX website: www.avx.com.



Effects of Mechanical Stress – High “K” dielectric ceramic capacitors exhibit some low level piezoelectric reactions under mechanical stress. As a general statement, the piezoelectric output is higher, the higher the dielectric constant of the ceramic. It is desirable to investigate this effect before using high “K” dielectrics as coupling capacitors in extremely low level applications.

Reliability – Historically ceramic capacitors have been one of the most reliable types of capacitors in use today. The approximate formula for the reliability of a ceramic capacitor is:

$$\frac{L_o}{L_t} = \left(\frac{V_t}{V_o}\right)^X \left(\frac{T_t}{T_o}\right)^Y$$

where

L_o = operating life T_t = test temperature and
 L_t = test life T_o = operating temperature
 V_t = test voltage in °C
 V_o = operating voltage X, Y = see text

Historically for ceramic capacitors exponent X has been considered as 3. The exponent Y for temperature effects typically tends to run about 8.

A capacitor is a component which is capable of storing electrical energy. It consists of two conductive plates (electrodes) separated by insulating material which is called the dielectric. A typical formula for determining capacitance is:

$$C = \frac{.224 KA}{t}$$

C = capacitance (picofarads)
 K = dielectric constant (Vacuum = 1)
 A = area in square inches
 t = separation between the plates in inches
 (thickness of dielectric)
 $.224$ = conversion constant
 (.0884 for metric system in cm)

Capacitance – The standard unit of capacitance is the farad. A capacitor has a capacitance of 1 farad when 1 coulomb charges it to 1 volt. One farad is a very large unit and most capacitors have values in the micro (10^{-6}), nano (10^{-9}) or pico (10^{-12}) farad level.

Dielectric Constant – In the formula for capacitance given above the dielectric constant of a vacuum is arbitrarily chosen as the number 1. Dielectric constants of other materials are then compared to the dielectric constant of a vacuum.

Dielectric Thickness – Capacitance is indirectly proportional to the separation between electrodes. Lower voltage requirements mean thinner dielectrics and greater capacitance per volume.

Area – Capacitance is directly proportional to the area of the electrodes. Since the other variables in the equation are usually set by the performance desired, area is the easiest parameter to modify to obtain a specific capacitance within a material group.

Energy Stored – The energy which can be stored in a capacitor is given by the formula:

$$E = \frac{1}{2}CV^2$$

E = energy in joules (watts-sec)
 V = applied voltage
 C = capacitance in farads

Potential Change – A capacitor is a reactive component which reacts against a change in potential across it. This is shown by the equation for the linear charge of a capacitor:

$$I_{ideal} = C \frac{dV}{dt}$$

where

I = Current
 C = Capacitance
 dV/dt = Slope of voltage transition across capacitor

Thus an infinite current would be required to instantly change the potential across a capacitor. The amount of current a capacitor can “sink” is determined by the above equation.

Equivalent Circuit – A capacitor, as a practical device, exhibits not only capacitance but also resistance and inductance. A simplified schematic for the equivalent circuit is:

C = Capacitance L = Inductance
 R_s = Series Resistance R_p = Parallel Resistance

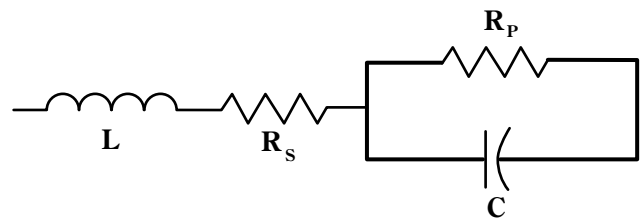

Reactance – Since the insulation resistance (R_p) is normally very high, the total impedance of a capacitor is:

$$Z = \sqrt{R_s^2 + (X_C - X_L)^2}$$

where

Z = Total Impedance
 R_s = Series Resistance
 X_C = Capacitive Reactance = $\frac{1}{2\pi fC}$
 X_L = Inductive Reactance = $2\pi fL$

The variation of a capacitor’s impedance with frequency determines its effectiveness in many applications.

Phase Angle – Power Factor and Dissipation Factor are often confused since they are both measures of the loss in a capacitor under AC application and are often almost identical in value. In a “perfect” capacitor the current in the capacitor will lead the voltage by 90°.

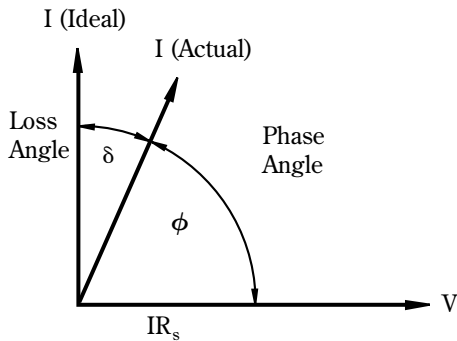

In practice the current leads the voltage by some other phase angle due to the series resistance R_s . The complement of this angle is called the loss angle and:

$$\text{Power Factor (P.F.)} = \cos \phi \text{ or } \sin \delta$$

$$\text{Dissipation Factor (D.F.)} = \tan \delta$$

for small values of δ the tan and sine are essentially equal which has led to the common interchangeability of the two terms in the industry.

Equivalent Series Resistance – The term E.S.R. or Equivalent Series Resistance combines all losses both series and parallel in a capacitor at a given frequency so that the equivalent circuit is reduced to a simple R-C series connection.

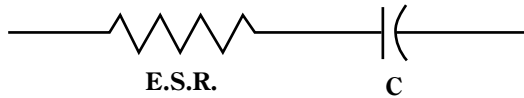

Dissipation Factor – The DF/PF of a capacitor tells what percent of the apparent power input will turn to heat in the capacitor.

$$\text{Dissipation Factor} = \frac{\text{E.S.R.}}{X_c} = (2 \pi fC) (\text{E.S.R.})$$

The watts loss are:

$$\text{Watts loss} = (2 \pi fCV^2) (\text{D.F.})$$

Very low values of dissipation factor are expressed as their reciprocal for convenience. These are called the “Q” or Quality factor of capacitors.

Parasitic Inductance – The parasitic inductance of capacitors is becoming more and more important in the decoupling of today’s high speed digital systems. The relationship between the inductance and the ripple voltage induced on the DC voltage line can be seen from the simple inductance equation:

$$V = L \frac{di}{dt}$$

The $\frac{di}{dt}$ seen in current microprocessors can be as high as 0.3 A/ns, and up to 10A/ns. At 0.3 A/ns, 100pH of parasitic inductance can cause a voltage spike of 30mV. While this does not sound very drastic, with the V_{cc} for microprocessors decreasing at the current rate, this can be a fairly large percentage.

Another important, often overlooked, reason for knowing the parasitic inductance is the calculation of the resonant frequency. This can be important for high frequency, bypass capacitors, as the resonant point will give the most signal attenuation. The resonant frequency is calculated from the simple equation:

$$f_{res} = \frac{1}{2\pi\sqrt{LC}}$$

Insulation Resistance – Insulation Resistance is the resistance measured across the terminals of a capacitor and consists principally of the parallel resistance R_p shown in the equivalent circuit. As capacitance values and hence the area of dielectric increases, the I.R. decreases and hence the product ($C \times IR$ or RC) is often specified in ohm farads or more commonly megohm-microfarads. Leakage current is determined by dividing the rated voltage by IR (Ohm’s Law).

Dielectric Strength – Dielectric Strength is an expression of the ability of a material to withstand an electrical stress. Although dielectric strength is ordinarily expressed in volts, it is actually dependent on the thickness of the dielectric and thus is also more generically a function of volts/mil.

Dielectric Absorption – A capacitor does not discharge instantaneously upon application of a short circuit, but drains gradually after the capacitance proper has been discharged. It is common practice to measure the dielectric absorption by determining the “reappearing voltage” which appears across a capacitor at some point in time after it has been fully discharged under short circuit conditions.

Corona – Corona is the ionization of air or other vapors which causes them to conduct current. It is especially prevalent in high voltage units but can occur with low voltages as well where high voltage gradients occur. The energy discharged degrades the performance of the capacitor and can in time cause catastrophic failures.

Surface Mounting Guide

MLC Chip Capacitors



REFLOW SOLDERING

| Case Size | D1 | D2 | D3 | D4 | D5 |
|-------------|--------------|--------------|--------------|--------------|--------------|
| 0201 | 0.85 (0.033) | 0.30 (0.012) | 0.25 (0.010) | 0.30 (0.012) | 0.35 (0.014) |
| 0402 | 1.70 (0.067) | 0.60 (0.024) | 0.50 (0.020) | 0.60 (0.024) | 0.50 (0.020) |
| 0603 | 2.30 (0.091) | 0.80 (0.031) | 0.70 (0.028) | 0.80 (0.031) | 0.75 (0.030) |
| 0805 | 3.00 (0.118) | 1.00 (0.039) | 1.00 (0.039) | 1.00 (0.039) | 1.25 (0.049) |
| 1206 | 4.00 (0.157) | 1.00 (0.039) | 2.00 (0.079) | 1.00 (0.039) | 1.60 (0.063) |
| 1210 | 4.00 (0.157) | 1.00 (0.039) | 2.00 (0.079) | 1.00 (0.039) | 2.50 (0.098) |
| 1808 | 5.60 (0.220) | 1.00 (0.039) | 3.60 (0.142) | 1.00 (0.039) | 2.00 (0.079) |
| 1812 | 5.60 (0.220) | 1.00 (0.039) | 3.60 (0.142) | 1.00 (0.039) | 3.00 (0.118) |
| 1825 | 5.60 (0.220) | 1.00 (0.039) | 3.60 (0.142) | 1.00 (0.039) | 6.35 (0.250) |
| 2220 | 6.60 (0.260) | 1.00 (0.039) | 4.60 (0.181) | 1.00 (0.039) | 5.00 (0.197) |
| 2225 | 6.60 (0.260) | 1.00 (0.039) | 4.60 (0.181) | 1.00 (0.039) | 6.35 (0.250) |

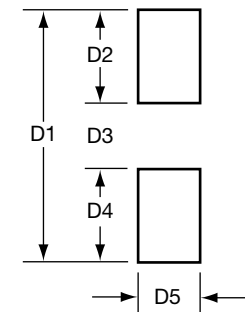

Dimensions in millimeters (inches)

Component Pad Design

Component pads should be designed to achieve good solder fillets and minimize component movement during reflow soldering. Pad designs are given below for the most common sizes of multilayer ceramic capacitors for both wave and reflow soldering. The basis of these designs is:

- Pad width equal to component width. It is permissible to decrease this to as low as 85% of component width but it is not advisable to go below this.
- Pad overlap 0.5mm beneath component.
- Pad extension 0.5mm beyond components for reflow and 1.0mm for wave soldering.

WAVE SOLDERING

| Case Size | D1 | D2 | D3 | D4 | D5 |
|-------------|-------------|-------------|-------------|-------------|-------------|
| 0603 | 3.10 (0.12) | 1.20 (0.05) | 0.70 (0.03) | 1.20 (0.05) | 0.75 (0.03) |
| 0805 | 4.00 (0.15) | 1.50 (0.06) | 1.00 (0.04) | 1.50 (0.06) | 1.25 (0.05) |
| 1206 | 5.00 (0.19) | 1.50 (0.06) | 2.00 (0.09) | 1.50 (0.06) | 1.60 (0.06) |

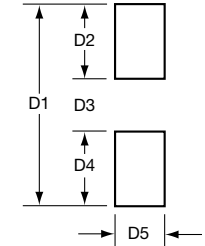

Dimensions in millimeters (inches)

Component Spacing

For wave soldering components, must be spaced sufficiently far apart to avoid bridging or shadowing (inability of solder to penetrate properly into small spaces). This is less important for reflow soldering but sufficient space must be allowed to enable rework should it be required.

Preheat & Soldering

The rate of preheat should not exceed 4°C/second to prevent thermal shock. A better maximum figure is about 2°C/second.

For capacitors size 1206 and below, with a maximum thickness of 1.25mm, it is generally permissible to allow a temperature differential from preheat to soldering of 150°C. In all other cases this differential should not exceed 100°C.

For further specific application or process advice, please consult AVX.

Cleaning

Care should be taken to ensure that the capacitors are thoroughly cleaned of flux residues especially the space beneath the capacitor. Such residues may otherwise become conductive and effectively offer a low resistance bypass to the capacitor.

Ultrasonic cleaning is permissible, the recommended conditions being 8 Watts/litre at 20-45 kHz, with a process cycle of 2 minutes vapor rinse, 2 minutes immersion in the ultrasonic solvent bath and finally 2 minutes vapor rinse.

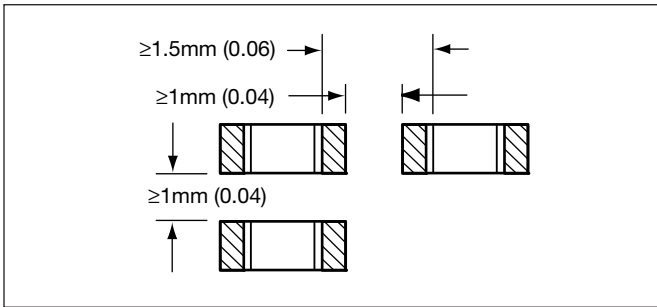

Recommended Soldering Profiles

REFLOW SOLDER PROFILES

AVX RoHS compliant products utilize termination finishes (e.g. Sn or SnAg) that are compatible with all Pb-Free soldering systems and are fully reverse compatible with SnPb soldering systems. A recommended SnPb profile is shown for comparison; for Pb-Free soldering, IPC/JEDECJ-STD-020C may be referenced. The upper line in the chart shows the maximum envelope to which products are qualified (typically 3x reflow cycles at 260°C max). The center line gives the recommended profile for optimum wettability and soldering in Pb-Free Systems.

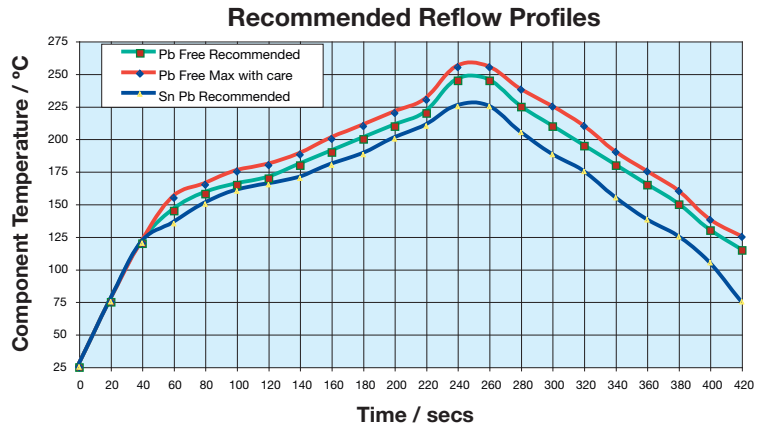

Preheat:

The pre-heat stabilizes the part and reduces the temperature differential prior to reflow. The initial ramp to 125°C may be rapid, but from that point (2-3)°C/sec is recommended to allow ceramic parts to heat uniformly and plastic encapsulated parts to stabilize through the glass transition temperature of the body (~ 180°C).

Reflow:

In the reflow phase, the maximum recommended time > 230°C is 40secs. Time at peak reflow is 10secs max.; optimum reflow is achieved at 250°C, (see wetting balance chart opposite) but products are qualified to 260°C max. Please reference individual product datasheets for maximum limits

Cool Down:

Cool down should not be forced and 6°C/sec is recommended. A slow cool down will result in a finer grain structure of the reflow solder in the solder fillet.

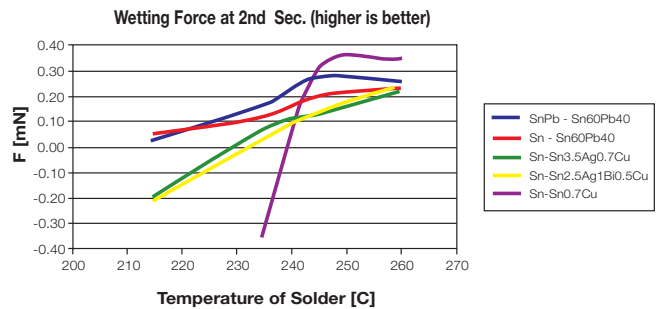

IMPORTANT NOTE: Typical Pb-Free reflow solders have a more dull and grainy appearance compared to traditional SnPb. Elevating the reflow temperature will not change this, but extending the cool down can help improve the visual appearance of the joint.

WAVE SOLDER PROFILES

For wave solder, there is no change in the recommended wave profile; all standard Pb-Free (SnCu/SnCuAg) systems operate at the same 260°C max recommended for SnPb systems.

Preheat:

This is more important for wave solder; a higher temperature preheat will reduce the thermal shock to SMD parts that are immersed (please consult individual product data sheets for SMD parts that are suited to wave solder). SMD parts should ideally be heated from the bottom-Side prior to wave. PTH (Pin through hole) parts on the topside should not be separately heated.

Wave:

250°C – 260°C recommended for optimum solderability.

Cool Down:

As with reflow solder, cool down should not be forced and 6°C/sec is recommended. Any air knives at the end of the 2nd wave should be heated.

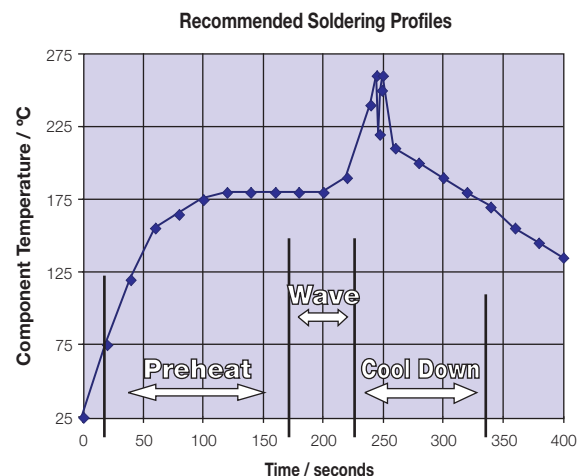

Surface Mounting Guide



MLC Chip Capacitors

APPLICATION NOTES

Storage

The components should be stored in their “as received packaging” where possible. If the components are removed from their original packaging then they should be stored in an airtight container (e.g. a heat sealed plastic bag) with desiccant (e.g. silica gel). Storage area temperature should be kept between +5 degrees C and +30 degrees C with humidity < 70% RH. Storage atmosphere must be free of gas containing sulfur and chlorine. Avoid exposing the product to saline moisture or to temperature changes that might result in the formation of condensation. To assure good solderability performance we recommend that the product be used within 6 months from our shipping date, but can be used for up to 12 months. Chip capacitors may crack if exposed to hydrogen (H₂) gas while sealed or if coated with silicon, which generates hydrogen gas.

Solderability

Terminations to be well soldered after immersion in a 60/40 tin/lead solder bath at 235 ± 5°C for 2 ± 1 seconds.

Leaching

Terminations will resist leaching for at least the immersion times and conditions shown below.

| Termination Type | Solder Tin/Lead/Silver | Solder Temp. °C | Immersion Time Seconds |
|------------------|------------------------|-----------------|------------------------|
| Nickel Barrier | 60/40/0 | 260 ± 5 | 30 ± 1 |

Lead-Free Wave Soldering

The recommended peak temperature for lead-free wave soldering is 250°C-260°C for 3-5 seconds. The other parameters of the profile remains the same as above.

The following should be noted by customers changing from lead based systems to the new lead free pastes.

- a) The visual standards used for evaluation of solder joints will need to be modified as lead free joints are not as bright as with tin-lead pastes and the fillet may not be as large.
- b) Lead-free solder pastes do not allow the same self alignment as lead containing systems. Standard mounting pads are acceptable, but machine set up may need to be modified.

General

Surface mounting chip multilayer ceramic capacitors are designed for soldering to printed circuit boards or other substrates. The construction of the components is such that they will withstand the time/temperature profiles used in both wave and reflow soldering methods.

Handling

Chip multilayer ceramic capacitors should be handled with care to avoid damage or contamination from perspiration and skin oils. The use of tweezers or vacuum pick ups is strongly recommended for individual components. Bulk handling should ensure that abrasion and mechanical shock are minimized. Taped and reeled components provides the ideal medium for direct presentation to the placement machine. Any mechanical shock should be minimized during handling chip multilayer ceramic capacitors.

Preheat

It is important to avoid the possibility of thermal shock during soldering and carefully controlled preheat is therefore required. The rate of preheat should not exceed 4°C/second and a target figure 2°C/second is recommended. Although an 80°C to 120°C temperature differential is preferred, recent developments allow a temperature differential between the component surface and the soldering temperature of 150°C (Maximum) for capacitors of 1210 size and below with a maximum thickness of 1.25mm. The user is cautioned that the risk of thermal shock increases as chip size or temperature differential increases.

Soldering

Mildly activated rosin fluxes are preferred. The minimum amount of solder to give a good joint should be used. Excessive solder can lead to damage from the stresses caused by the difference in coefficients of expansion between solder, chip and substrate. AVX terminations are suitable for all wave and reflow soldering systems. If hand soldering cannot be avoided, the preferred technique is the utilization of hot air soldering tools.

Cooling

Natural cooling in air is preferred, as this minimizes stresses within the soldered joint. When forced air cooling is used, cooling rate should not exceed 4°C/second. Quenching is not recommended but if used, maximum temperature differentials should be observed according to the preheat conditions above.

Cleaning

Flux residues may be hygroscopic or acidic and must be removed. AVX MLC capacitors are acceptable for use with all of the solvents described in the specifications MIL-STD-202 and EIA-RS-198. Alcohol based solvents are acceptable and properly controlled water cleaning systems are also acceptable. Many other solvents have been proven successful, and most solvents that are acceptable to other components on circuit assemblies are equally acceptable for use with ceramic capacitors.

Surface Mounting Guide



MLC Chip Capacitors

POST SOLDER HANDLING

Once SMP components are soldered to the board, any bending or flexure of the PCB applies stresses to the soldered joints of the components. For leaded devices, the stresses are absorbed by the compliancy of the metal leads and generally don't result in problems unless the stress is large enough to fracture the soldered connection.

Ceramic capacitors are more susceptible to such stress because they don't have compliant leads and are brittle in nature. The most frequent failure mode is low DC resistance or short circuit. The second failure mode is significant loss of capacitance due to severing of contact between sets of the internal electrodes.

Cracks caused by mechanical flexure are very easily identified and generally take one of the following two general forms:

Mechanical cracks are often hidden underneath the termination and are difficult to see externally. However, if one end termination falls off during the removal process from PCB, this is one indication that the cause of failure was excessive mechanical stress due to board warping.

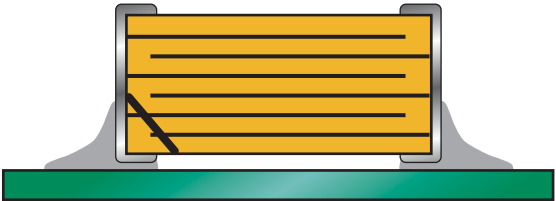

Type A:
Angled crack between bottom of device to top of solder joint.



Type B:
Fracture from top of device to bottom of device.

MLC Chip Capacitors

COMMON CAUSES OF MECHANICAL CRACKING

The most common source for mechanical stress is board depanelization equipment, such as manual breakapart, v-cutters and shear presses. Improperly aligned or dull cutters may cause torqueing of the PCB resulting in flex stresses being transmitted to components near the board edge. Another common source of flexural stress is contact during parametric testing when test points are probed. If the PCB is allowed to flex during the test cycle, nearby ceramic capacitors may be broken.

A third common source is board to board connections at vertical connectors where cables or other PCBs are connected to the PCB. If the board is not supported during the plug/unplug cycle, it may flex and cause damage to nearby components.

Special care should also be taken when handling large (>6" on a side) PCBs since they more easily flex or warp than smaller boards.

REWORKING OF MLCs

Thermal shock is common in MLCs that are manually attached or reworked with a soldering iron. *AVX strongly recommends that any reworking of MLCs be done with hot air reflow rather than soldering irons.* It is practically impossible to cause any thermal shock in ceramic capacitors when using hot air reflow.

However direct contact by the soldering iron tip often causes thermal cracks that may fail at a later date. If rework by soldering iron is absolutely necessary, it is recommended that the wattage of the iron be less than 30 watts and the tip temperature be <math><300^{\circ}\text{C}</math>. *Rework should be performed by applying the solder iron tip to the pad and not directly contacting any part of the ceramic capacitor.*

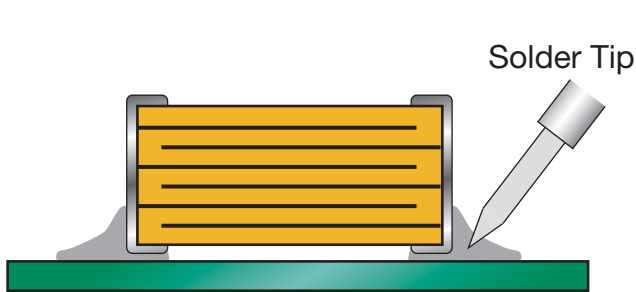

Preferred Method - No Direct Part Contact

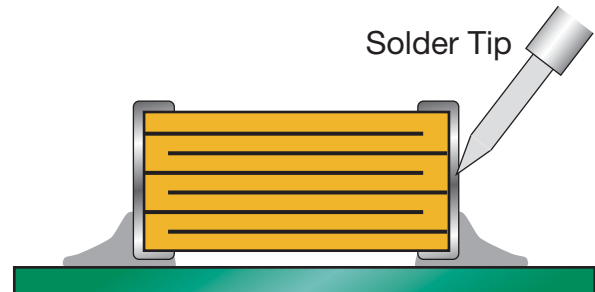

Poor Method - Direct Contact with Part

PCB BOARD DESIGN

To avoid many of the handling problems, AVX recommends that MLCs be located at least .2" away from nearest edge of board. However when this is not possible, AVX recommends that the panel be routed along the cut line, adjacent to where the MLC is located.

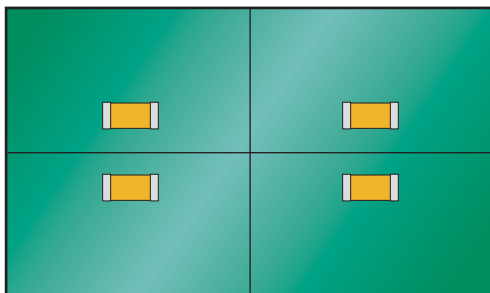

No Stress Relief for MLCs

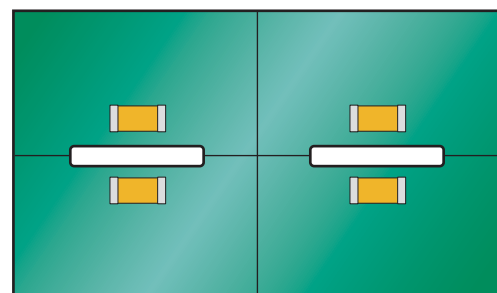

Routed Cut Line Relieves Stress on MLC

AMERICAS

AVX Myrtle Beach, SC
Tel: 843-448-9411

AVX Northwest, WA
Tel: 360-699-8746

AVX Midwest, IN
Tel: 317-861-9184

AVX Mid/Pacific, CA
Tel: 408-988-4900

AVX Northeast, MA
Tel: 617-479-0345

AVX Southwest, CA
Tel: 949-859-9509

AVX Canada
Tel: 905-238-3151

AVX South America
Tel: +55-11-4688-1960

EUROPE

AVX Limited, England
Tel: +44-1252-770000

AVX S.A.S., France
Tel: +33-1-69-18-46-00

AVX GmbH, Germany
Tel: +49-8131-9004-0

AVX SRL, Italy
Tel: +39-02-614-571

AVX Czech Republic
Tel: +420-57-57-57-521

AVX/ELCO UK
Tel: +44-1638-675000

ELCO Europe GmbH
Tel: +49-2741-299-0

AVX S.A., Spain
Tel: +34-91-63-97-197

AVX Benelux
Tel: +31-187-489-337

ASIA-PACIFIC

**AVX/Kyocera (S) Pte Ltd.,
Singapore**
Tel: +65-6286-7555

**AVX/Kyocera, Asia, Ltd.,
Hong Kong**
Tel: +852-2363-3303

**AVX/Kyocera Yuhan Hoesa,
South Korea**
Tel: +82-2785-6504

**AVX/Kyocera HK Ltd.,
Taiwan**
Tel: +886-2-2698-8778

**AVX/Kyocera (M) Sdn Bhd,
Malaysia**
Tel: +60-4228-1190

**AVX/Kyocera International
Trading Co. Ltd.,
Shanghai**
Tel: +86-21-6215-5588

**AVX/Kyocera Asia Ltd.,
Shenzen**
Tel: +86-755-3336-0615

**AVX/Kyocera International
Trading Co. Ltd.,
Beijing**
Tel: +86-10-6588-3528

**AVX/Kyocera India
Liaison Office**
Tel: +91-80-6450-0715

ASIA-KED (KYOCERA Electronic Devices)

KED Hong Kong Ltd.
Tel: +852-2305-1080/1223

**KED Hong Kong Ltd.
Shenzen**
Tel: +86-755-3398-9600

**KED Company Ltd.
Shanghai**
Tel: +86-21-6217-1201

**KED Hong Kong Ltd.
Beijing**
Tel: +86-10-5869-4655

KED Taiwan Ltd.
Tel: +886-2-2950-0268

**KED Korea Yuhan Hoesa,
South Korea**
Tel: +82-2-783-3604/6126

**KED (S) Pte Ltd.
Singapore**
Tel: +65-6509-0328

**Kyocera Corporation
Japan**
Tel: +81-75-604-3449

Contact:

