

ANSALDO**Ansaldo Trasporti s.p.a.
Unita' Semiconduttori**Via N. Lorenzi 8 - I 16152 GENOVA - ITALY
Tel. int. +39/(0)10 6556549 - (0)10 6556488
Fax Int. +39/(0)10 6442510
Tx 270318 ANSUSE I -**PHASE CONTROL THYRISTOR****AT603**

Repetitive voltage up to	1600 V
Mean on-state current	720 A
Surge current	8.8 kA

FINAL SPECIFICATION

feb 97 - ISSUE : 03

Symbol	Characteristic	Conditions	T _j [°C]	Value	Unit
BLOCKING					
V _{RRM}	Repetitive peak reverse voltage		125	1600	V
V _{RSM}	Non-repetitive peak reverse voltage		125	1700	V
V _{DRM}	Repetitive peak off-state voltage		125	1600	V
I _{RRM}	Repetitive peak reverse current	V=V _{RRM}	125	50	mA
I _{DRM}	Repetitive peak off-state current	V=V _{DRM}	125	50	mA
CONDUCTING					
I _{T(AV)}	Mean on-state current	180° sin, 50 Hz, Th=55°C, double side cooled		720	A
I _{T(AV)}	Mean on-state current	180° sin, 50 Hz, Tc=85°C, double side cooled		630	A
I _{TSM}	Surge on-state current	sine wave, 10 ms	125	8.8	kA
I ² t	I ² t	without reverse voltage		387 x1E3	A ² s
V _T	On-state voltage	On-state current = 1000 A	25	1.5	V
V _{T(TO)}	Threshold voltage		125	0.91	V
r _T	On-state slope resistance		125	0.580	mohm
SWITCHING					
di/dt	Critical rate of rise of on-state current, min.	From 75% V _{DRM} up to 860 A, gate 10V 5ohm	125	200	A/μs
dv/dt	Critical rate of rise of off-state voltage, min.	Linear ramp up to 70% of V _{DRM}	125	500	V/μs
t _d	Gate controlled delay time, typical	V _D =100V, gate source 10V, 10 ohm, tr=.5 μs	25	1.3	μs
t _q	Circuit commutated turn-off time, typical	dV/dt = 20 V/μs linear up to 75% V _{DRM}		250	μs
Q _{rr}	Reverse recovery charge	di/dt=-20 A/μs, I _s = 560 A	125		μC
I _{rr}	Peak reverse recovery current	V _R = 50 V			A
I _H	Holding current, typical	V _D =5V, gate open circuit	25	300	mA
I _L	Latching current, typical	V _D =5V, tp=30μs	25	700	mA
GATE					
V _{GT}	Gate trigger voltage	V _D =5V	25	3.5	V
I _{GT}	Gate trigger current	V _D =5V	25	200	mA
V _{GD}	Non-trigger gate voltage, min.	V _D =V _{DRM}	125	0.25	V
V _{FGM}	Peak gate voltage (forward)			30	V
I _{FGM}	Peak gate current			10	A
V _{RGM}	Peak gate voltage (reverse)			5	V
P _{GM}	Peak gate power dissipation	Pulse width 100 μs		150	W
P _G	Average gate power dissipation			2	W
MOUNTING					
R _{th(j-h)}	Thermal impedance, DC	Junction to heatsink, double side cooled		50	°C/kW
R _{th(c-h)}	Thermal impedance	Case to heatsink, double side cooled		15	°C/kW
T _j	Operating junction temperature			-30 / 125	°C
F	Mounting force			8.0 / 9.0	kN
	Mass			85	g
ORDERING INFORMATION : AT603 S 16					
standard specification <input type="checkbox"/> <input type="checkbox"/> VDRM&VRRM/100					

DISSIPATION CHARACTERISTICS

SINE WAVE

Th [°C]

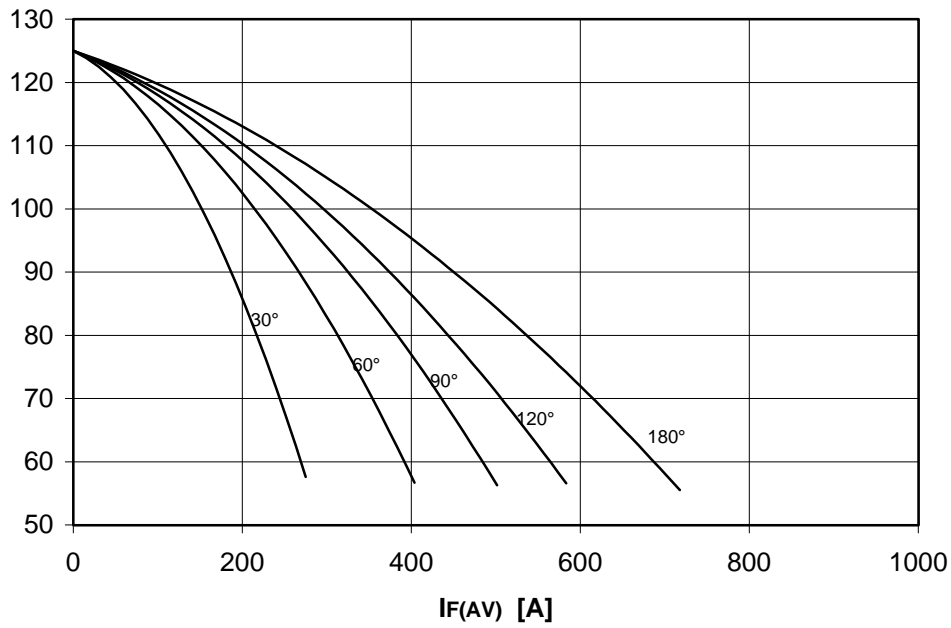

PF(AV) [W]

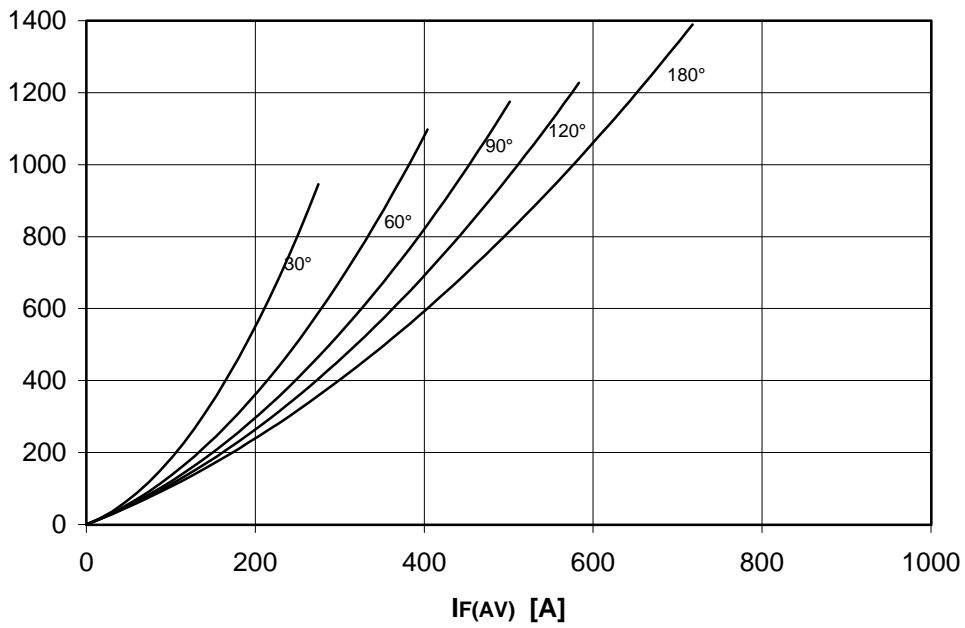

ON-STATE CHARACTERISTIC
T_j = 125 °C

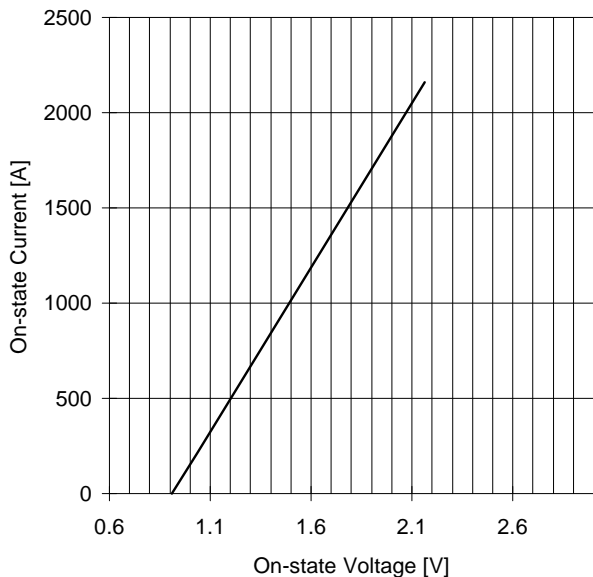

SURGE CHARACTERISTIC
T_j = 125 °C

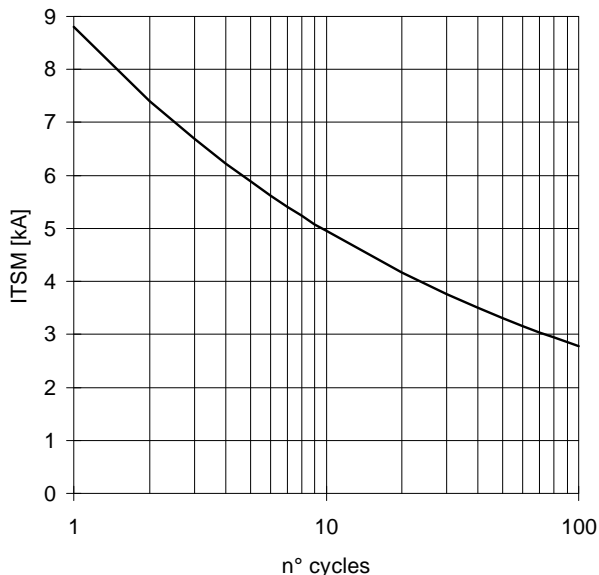

TRANSIENT THERMAL IMPEDANCE
DOUBLE SIDE COOLED

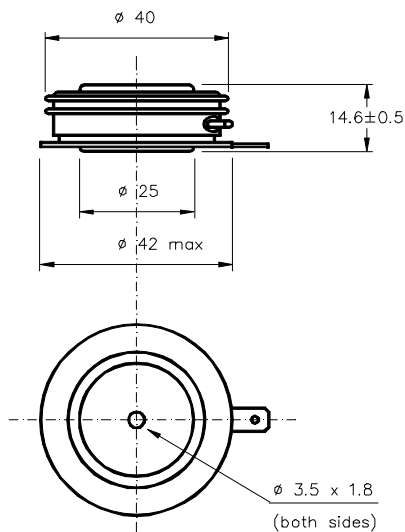
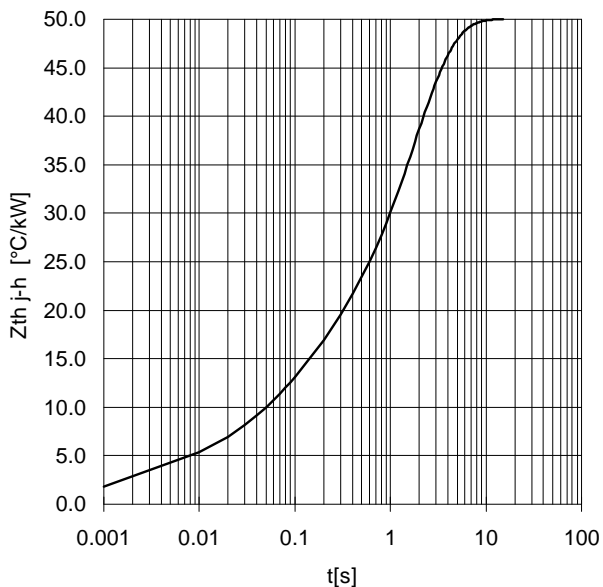

Dimensions
in mm

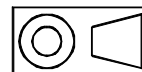

Cathode terminal type DIN 46244 - A 4.8 - 0.8

Gate terminal type AMP 60598 - 1

All the characteristics given in this data sheet are guaranteed only with uniform clamping force, cleaned and lubricated heatsink, surfaces with flatness < .03 mm and roughness < 2 μm .

In the interest of product improvement ANSALDO reserves the right to change any data given in this data sheet at any time without previous notice.

If not stated otherwise the maximum value of ratings (symbols over shaded background) and characteristics is reported.

Distributed by

