

HIGH VOLTAGE AMPLIFIER

DESCRIPTION

The BC394 is a silicon planar epitaxial NPN transistor in Jedec TO-18 metal case, designed for general purpose high-voltage and video amplifier applications.

The complementary PNP type is the BC393.

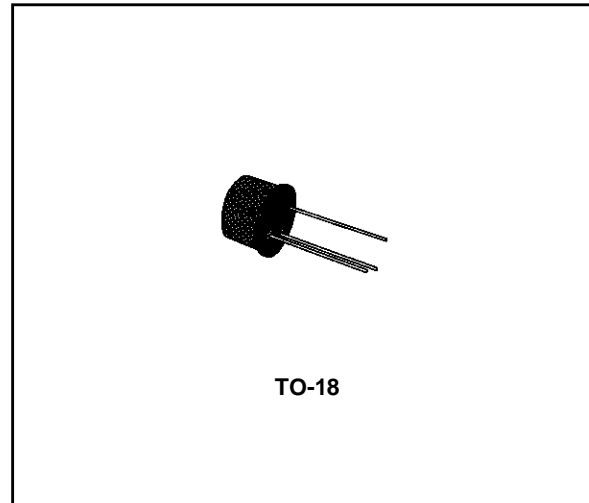

INTERNAL SCHEMATIC DIAGRAM

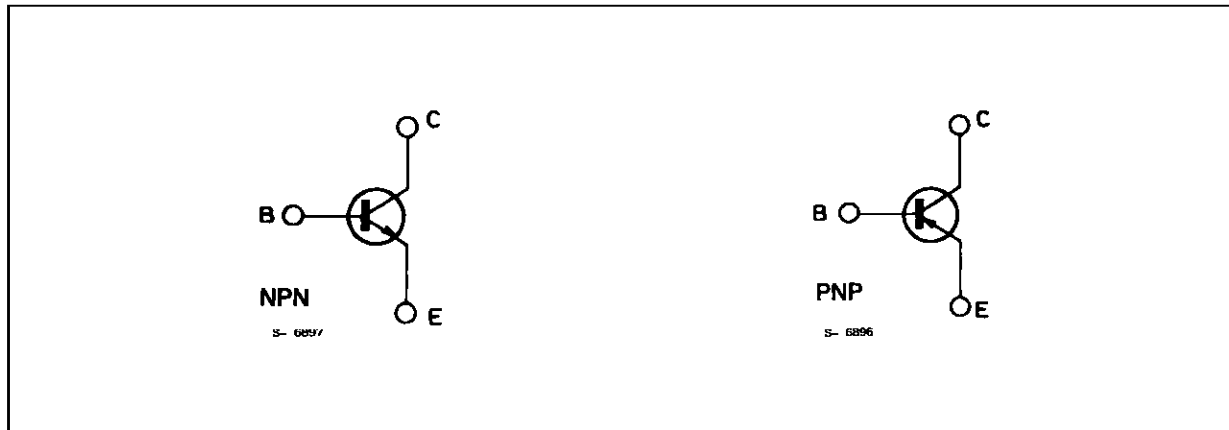

ABSOLUTE MAXIMUM RATINGS

Symbol	Parameter	Value	Unit
V_{CBO}	Collector-base Voltage ($I_E = 0$)	180	V
V_{CEO}	Collector-emitter Voltage ($I_B = 0$)	180	V
V_{EBO}	Emitter-base Voltage ($I_C = 0$)	6	V
I_C	Collector Current	100	mA
P_{tot}	Total Power Dissipation at $T_{amb} \leq 25\text{ }^\circ\text{C}$ at $T_{case} \leq 25\text{ }^\circ\text{C}$	0.4	W
		1.4	W
T_{stg}	Storage Temperature	- 55 to 200	$^\circ\text{C}$
T_j	Junction Temperature	200	$^\circ\text{C}$

BC394

THERMAL DATA

$R_{th\ j-case}$	Thermal Resistance Junction-case	Max	125	$^{\circ}C/W$
$R_{th\ j-amb}$	Thermal Resistance Junction-ambient	Max	440	$^{\circ}C/W$

ELECTRICAL CHARACTERISTICS ($T_{amb} = 25^{\circ}C$ unless otherwise specified)

Symbol	Parameter	Test Conditions	Min.	Typ.	Max.	Unit
I_{CBO}	Collector Cutoff Current ($I_E = 0$)	$V_{CB} = 100\ V$ $V_{CB} = 100\ V$ $T_{amb} = 150^{\circ}C$			50 50	nA μA
$V_{(BR)\ CBO}$	Collector-base Breakdown Voltage ($I_E = 0$)	$I_C = 100\ \mu A$	180			V
$V_{(BR)\ CEO}^*$	Collector-emitter Breakdown Voltage ($I_B = 0$)	$I_C = 10\ mA$	180			V
$V_{(BR)\ EBO}$	Emitter-base Breakdown Voltage ($I_C = 0$)	$I_E = 100\ \mu A$	6			V
$V_{CE\ (sat)}^*$	Collector-emitter Saturation Voltage	$I_C = 10\ mA$ $I_B = 1\ mA$ $I_C = 50\ mA$ $I_B = 5\ mA$		200 400	300	mV mV
$V_{BE\ (sat)}^*$	Base-emitter Saturation Voltage	$I_C = 10\ mA$ $I_B = 1\ mA$ $I_C = 50\ mA$ $I_B = 5\ mA$		750 850	900	mV mV
h_{FE}^*	DC Current Gain	$I_C = 1\ mA$ $V_{CE} = 10\ V$ $I_C = 10\ mA$ $V_{CE} = 10\ V$	30	85 100		
f_T	Transition frequency	$I_C = 10\ mA$ $V_{CE} = 10\ V$	50	95		MHz
C_{CBO}	Collector-base Capacitance	$I_E = 0$ $V_{CB} = 10\ V$ $f = 1\ MHz$		5		pF

* Pulsed : pulse duration = 300 μs , duty cycle = 1 %.

DC Current.

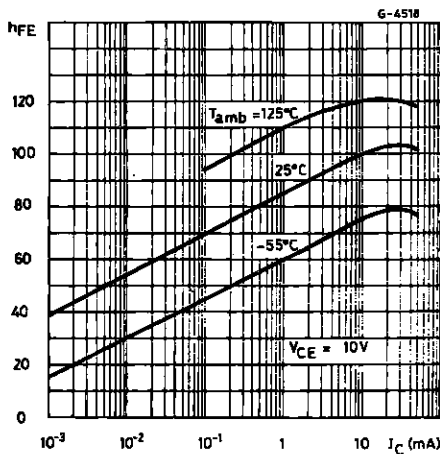

Collector-emitter Saturation Voltage.

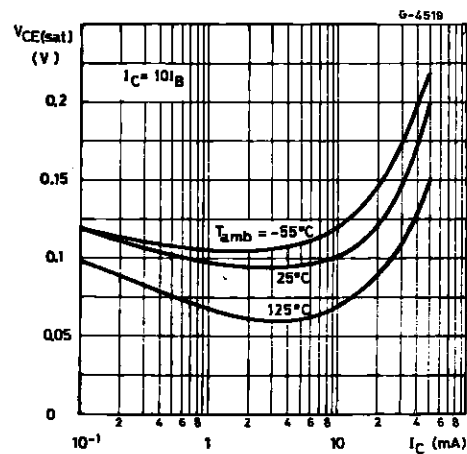

Base-emitter Saturation Voltage.

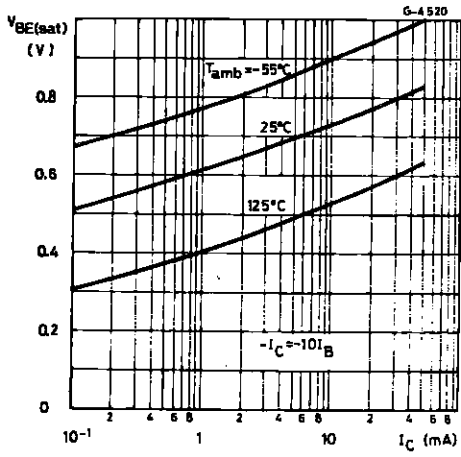

Transition Frequency.

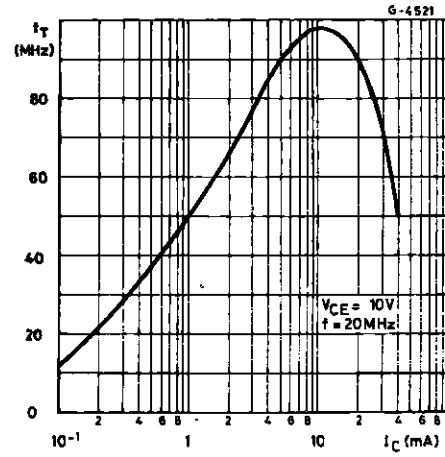

TO39 MECHANICAL DATA

DIM.	mm			inch		
	MIN.	TYP.	MAX.	MIN.	TYP.	MAX.
A	12.7			0.500		
B			0.49			0.019
D			6.6			0.260
E			8.5			0.334
F			9.4			0.370
G	5.08			0.200		
H			1.2			0.047
I			0.9			0.035
L	45° (typ.)					

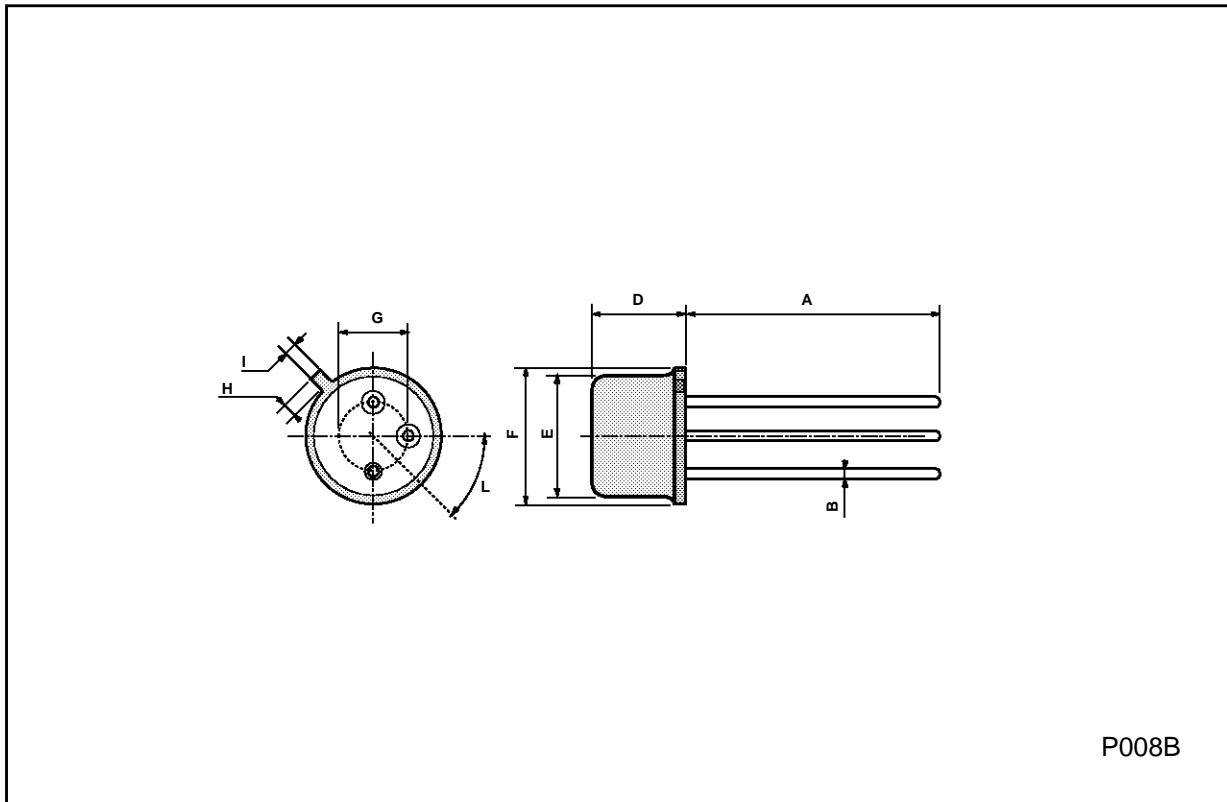

P008B

Information furnished is believed to be accurate and reliable. However, SGS-THOMSON Microelectronics assumes no responsibility for the consequences of use of such information nor for any infringement of patents or other rights of third parties which may result from its use. No license is granted by implication or otherwise under any patent or patent rights of SGS-THOMSON Microelectronics. Specifications mentioned in this publication are subject to change without notice. This publication supersedes and replaces all information previously supplied. SGS-THOMSON Microelectronics products are not authorized for use as critical components in life support devices or systems without express written approval of SGS-THOMSON Microelectronics.

© 1994 SGS-THOMSON Microelectronics - All Rights Reserved

SGS-THOMSON Microelectronics GROUP OF COMPANIES

Australia - Brazil - France - Germany - Hong Kong - Italy - Japan - Korea - Malaysia - Malta - Morocco - The Netherlands -
Singapore - Spain - Sweden - Switzerland - Taiwan - Thailand - United Kingdom - U.S.A