

PNP Silicon AF Transistors

- For general AF applications
- High collector current
- High current gain
- Low collector-emitter saturation voltage
- Complementary types: BC817W, BC818W (NPN)

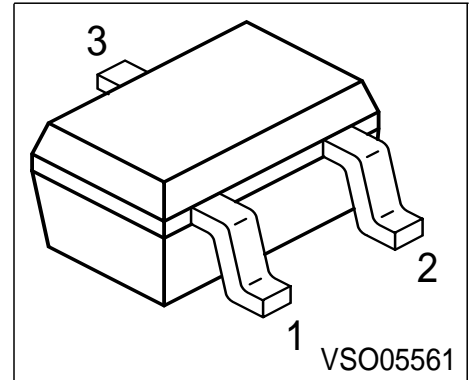

| Type | Marking | Pin Configuration | | | Package |
|-----------|---------|-------------------|-------|-------|---------|
| BC807-16W | 5As | 1 = B | 2 = E | 3 = C | SOT323 |
| BC807-25W | 5Bs | 1 = B | 2 = E | 3 = C | SOT323 |
| BC807-40W | 5Cs | 1 = B | 2 = E | 3 = C | SOT323 |
| BC808-16W | 5Es | 1 = B | 2 = E | 3 = C | SOT323 |
| BC808-25W | 5Fs | 1 = B | 2 = E | 3 = C | SOT323 |
| BC808-40W | 5Gs | 1 = B | 2 = E | 3 = C | SOT323 |

Maximum Ratings

| Parameter | Symbol | BC 807W | BC 808W | Unit |
|--|-----------|-------------|---------|------|
| Collector-emitter voltage | V_{CEO} | 45 | 25 | V |
| Collector-base voltage | V_{CBO} | 50 | 30 | |
| Emitter-base voltage | V_{EBO} | 5 | 5 | |
| DC collector current | I_C | 500 | | mA |
| Peak collector current | I_{CM} | 1 | | A |
| Base current | I_B | 100 | | mA |
| Peak base current | I_{BM} | 200 | | |
| Total power dissipation, $T_S = 130\text{ °C}$ | P_{tot} | 250 | | mW |
| Junction temperature | T_j | 150 | | °C |
| Storage temperature | T_{stg} | -65 ... 150 | | |

Thermal Resistance

| | | | |
|--|------------|-----|-----|
| Junction - soldering point ¹⁾ | R_{thJS} | ≤80 | K/W |
|--|------------|-----|-----|

¹⁾For calculation of R_{thJA} please refer to Application Note Thermal Resistance

Electrical Characteristics at $T_A = 25^\circ\text{C}$, unless otherwise specified.

| Parameter | Symbol | Values | | | Unit |
|--|---------------|--------|------|------|---------------|
| | | min. | typ. | max. | |
| DC Characteristics | | | | | |
| Collector-emitter breakdown voltage $I_C = 10\text{ mA}, I_B = 0$ | $V_{(BR)CEO}$ | | | | V |
| BC807W | | 45 | - | - | |
| BC808W | | 25 | - | - | |
| Collector-base breakdown voltage $I_C = 10\text{ }\mu\text{A}, I_E = 0$ | $V_{(BR)CBO}$ | | | | |
| BC807W | | 50 | - | - | |
| BC808W | | 30 | - | - | |
| Emitter-base breakdown voltage $I_E = 10\text{ }\mu\text{A}, I_C = 0$ | $V_{(BR)EBO}$ | 5 | - | - | |
| Collector cutoff current $V_{CB} = 25\text{ V}, I_E = 0$ | I_{CBO} | - | - | 100 | nA |
| Collector cutoff current $V_{CB} = 25\text{ V}, I_E = 0, T_A = 150\text{ }^\circ\text{C}$ | I_{CBO} | - | - | 50 | μA |
| Emitter cutoff current $V_{EB} = 4\text{ V}, I_C = 0$ | I_{EBO} | - | - | 100 | nA |
| DC current gain 1) $I_C = 100\text{ mA}, V_{CE} = 1\text{ V}$ | h_{FE} | | | | - |
| $h_{FE}\text{-grp. 16}$ | | 100 | 160 | 250 | |
| $h_{FE}\text{-grp. 25}$ | | 160 | 250 | 400 | |
| $h_{FE}\text{-grp. 40}$ | | 250 | 350 | 630 | |
| DC current gain 1) $I_C = 500\text{ mA}, V_{CE} = 1\text{ V}$ | h_{FE} | 40 | - | - | |
| Collector-emitter saturation voltage1) $I_C = 500\text{ mA}, I_B = 50\text{ mA}$ | V_{CEsat} | - | - | 0.7 | V |
| Base-emitter saturation voltage 1) $I_C = 500\text{ mA}, I_B = 50\text{ mA}$ | V_{BEsat} | - | - | 1.2 | |

1) Pulse test: $t \leq 300\mu\text{s}$, $D = 2\%$

Electrical Characteristics at $T_A = 25^\circ\text{C}$, unless otherwise specified.

| Parameter | Symbol | Values | | | Unit |
|---|----------|--------|------|------|------|
| | | min. | typ. | max. | |
| AC Characteristics | | | | | |
| Transition frequency $I_C = 50\text{ mA}, V_{CE} = 5\text{ V}, f = 100\text{ MHz}$ | f_T | - | 200 | - | MHz |
| Collector-base capacitance $V_{CB} = 10\text{ V}, f = 1\text{ MHz}$ | C_{cb} | - | 10 | - | pF |
| Emitter-base capacitance $V_{EB} = 0.5\text{ V}, f = 1\text{ MHz}$ | C_{eb} | - | 60 | - | |

Total power dissipation $P_{tot} = f(T_S)$

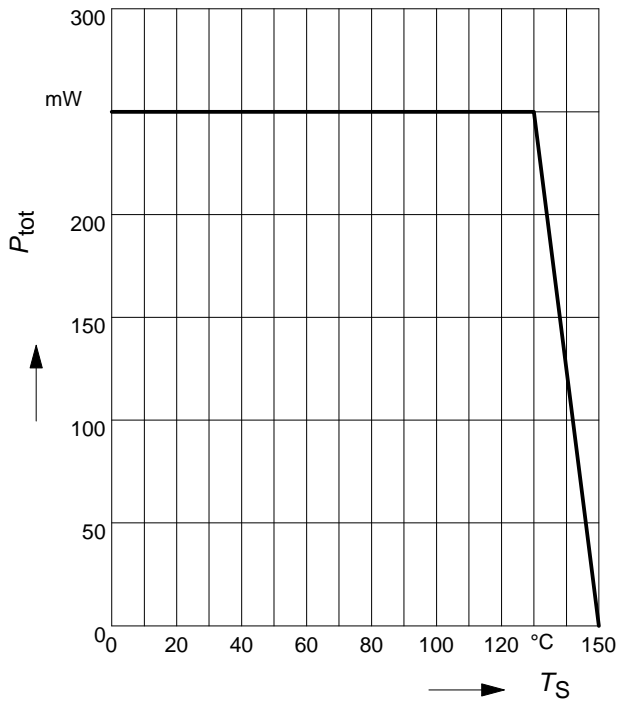

Permissible Pulse Load $R_{thJS} = f(t_p)$

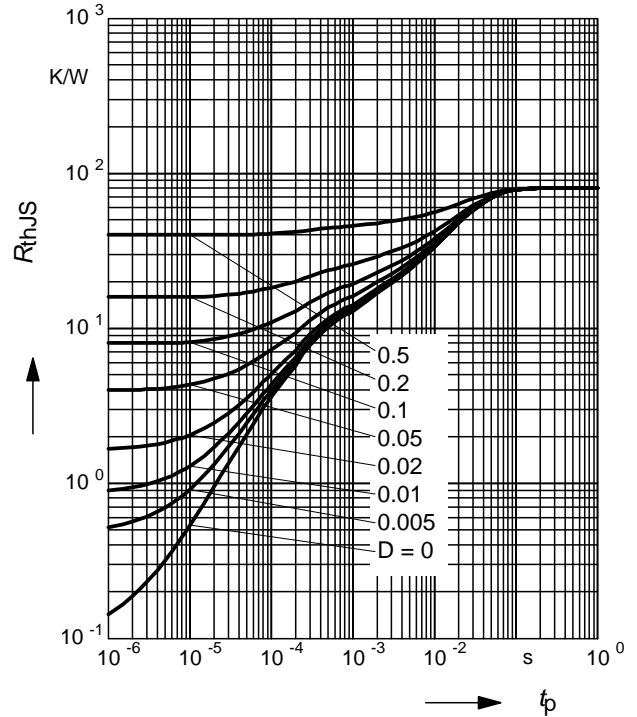

Permissible Pulse Load

$$P_{totmax} / P_{totDC} = f(t_p)$$

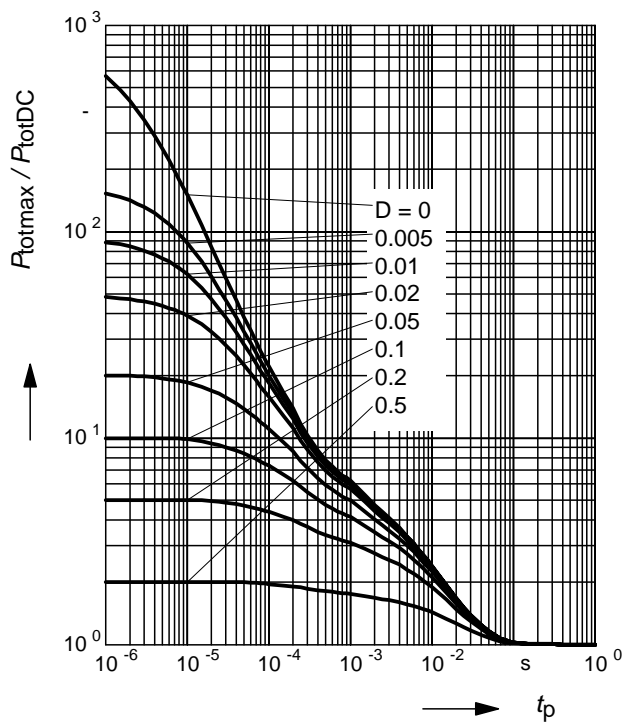

Collector cutoff current $I_{CBO} = f(T_A)$

$$V_{CB} = 25V$$

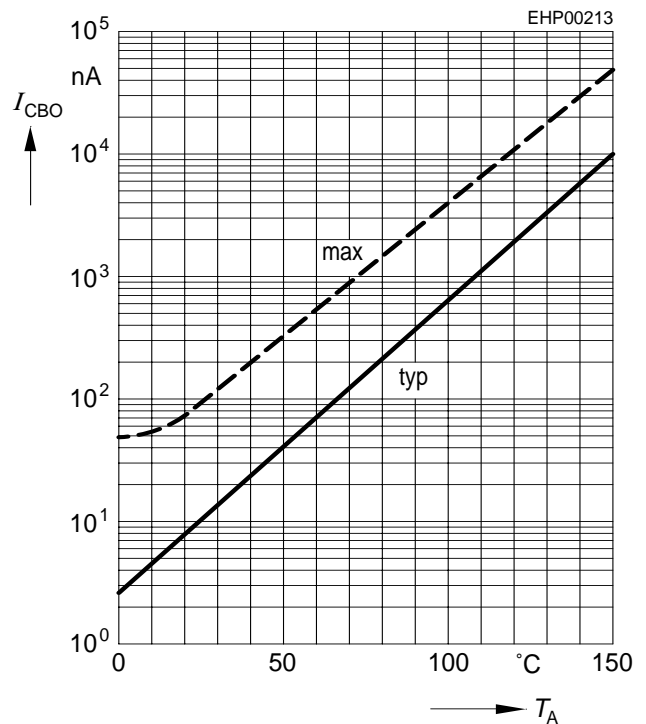

DC current gain $h_{FE} = f(I_C)$

$V_{CE} = 1V$

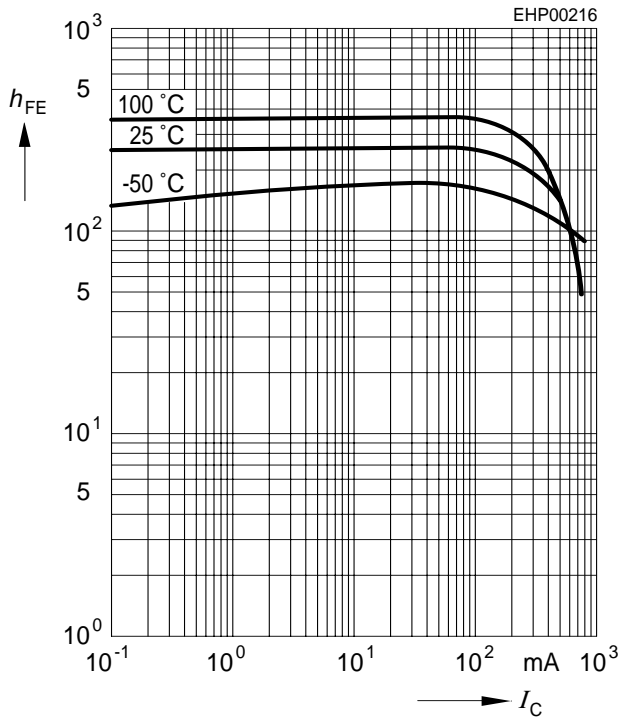

Transition frequency $f_T = f(I_C)$

$V_{CE} = 5V$

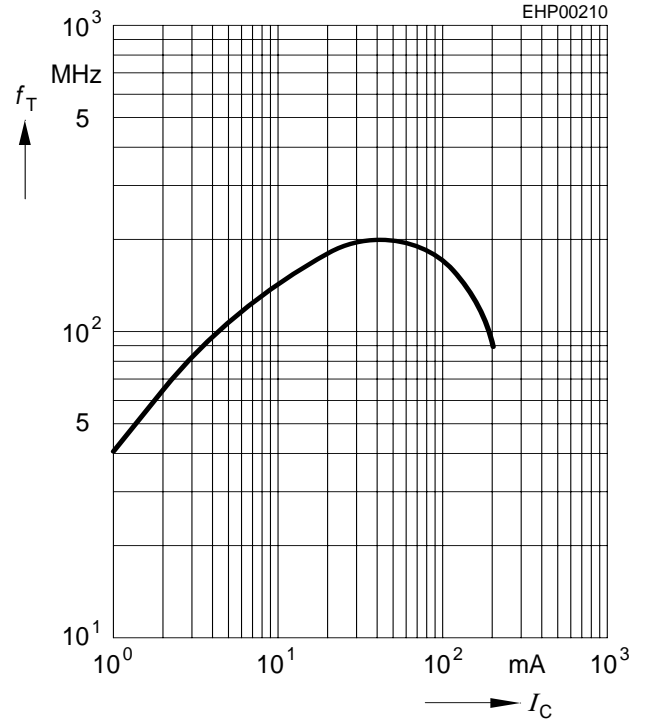

Base-emitter saturation voltage

$I_C = f(V_{BEsat}), h_{FE} = 10$

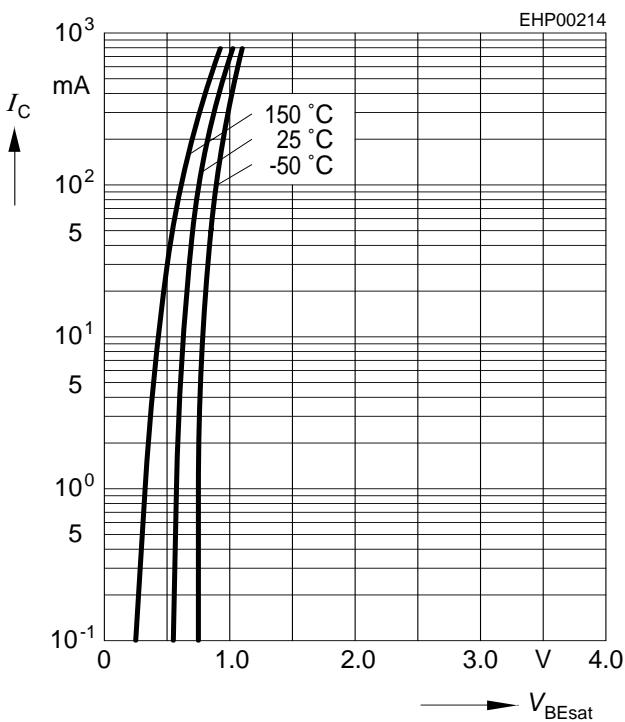

Collector-emitter saturation voltage

$I_C = f(V_{CEsat}), h_{FE} = 10$

