

Small Signal Transistors (PNP)

Features

- PNP Silicon Epitaxial Planar Transistors for switching and AF amplifier applications.
- Especially suited for automatic insertion in thick and thin-film circuits.
- These transistors are subdivided into three groups A, B, and C) according to their current gain. The type BC856 is available in groups A and B, however, the types BC857, BC558 and BC859 can be supplied in all three groups. The BC849 is a low noise type.

- As complementary types, the NPN transistors BC846...BC849 are recommended.

Mechanical Data

Case: SOT-23 Plastic case

Weight: approx. 8.8 mg

Marking:

BC856A = 3A	BC858A = 3J
BC856B = 3B	BC858B = 3K
	BC858C = 3L

BC857A = 3E	BC859A = 4A
BC857B = 3F	BC859B = 4B
BC857C = 3G	BC859C = 4C

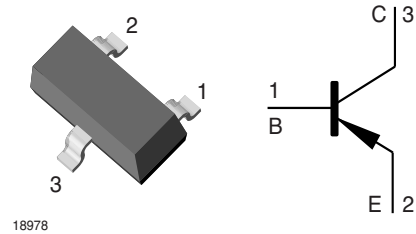

Packaging Codes/Options:

GS18 / 10 k per 13" reel (8 mm tape), 10 k/box

GS08 / 3 k per 7" reel (8 mm tape), 15 k/box

Pinning:

1 = Base, 2 = Emitter, 3 = Collector

Absolute Maximum Ratings

$T_{amb} = 25\text{ °C}$, unless otherwise specified

Parameter	Test condition	Part	Symbol	Value	Unit
Collector - base voltage		BC856	$-V_{CBO}$	80	V
		BC857	$-V_{CBO}$	50	V
		BC858	$-V_{CBO}$	30	V
		BC859	$-V_{CBO}$	30	V
Collector - emitter voltage (base shorted)		BC856	$-V_{CES}$	80	V
		BC857	$-V_{CES}$	50	V
		BC858	$-V_{CES}$	30	V
		BC859	$-V_{CES}$	30	V
Collector - emitter voltage (base open)		BC856	$-V_{CEO}$	65	V
		BC857	$-V_{CEO}$	45	V
		BC858	$-V_{CEO}$	30	V
		BC859	$-V_{CEO}$	30	V
Emitter - base voltage			$-V_{EBO}$	5	V
Collector current			$-I_C$	100	mA
Peak collector current			$-I_{CM}$	200	mA
Peak base current			$-I_{BM}$	200	mA
Peak emitter current			I_{EM}	200	mA
Power dissipation	$T_{amb} = 25\text{ °C}$		P_{tot}	310 ¹⁾	mW

¹⁾ Device on fiberglass substrate, see layout on third page.

Maximum Thermal Resistance

Parameter	Test condition	Symbol	Value	Unit
Thermal resistance junction to ambient air		$R_{\theta JA}$	320 ¹⁾	°C/W
Thermal resistance junction to substrate backside		$R_{\theta SB}$	450 ¹⁾	°C/W
Junction temperature		T_j	150	°C
Storage temperature range		T_S	- 65 to + 150	°C

¹⁾ Device on fiberglass substrate, see layout on third page.

Electrical DC Characteristics

Parameter	Test condition	Part	Symbol	Min	Typ	Max	Unit
Small signal current gain (current gain group A)	$-V_{CE} = 5\text{ V}$, $-I_C = 2\text{ mA}$, $f = 1\text{ kHz}$		h_{fe}		220		
Small signal current gain (current gain group B)	$-V_{CE} = 5\text{ V}$, $-I_C = 2\text{ mA}$, $f = 1\text{ kHz}$		h_{fe}		330		
Small signal current gain (current gain group C)	$-V_{CE} = 5\text{ V}$, $-I_C = 2\text{ mA}$, $f = 1\text{ kHz}$		h_{fe}		600		
Input impedance (current gain group A)	$-V_{CE} = 5\text{ V}$, $-I_C = 2\text{ mA}$, $f = 1\text{ kHz}$		h_{ie}	1.6	2.7	4.5	k Ω
Input impedance (current gain group B)	$-V_{CE} = 5\text{ V}$, $-I_C = 2\text{ mA}$, $f = 1\text{ kHz}$		h_{ie}	3.2	4.5	8.5	k Ω
Input impedance (current gain group C)	$-V_{CE} = 5\text{ V}$, $-I_C = 2\text{ mA}$, $f = 1\text{ kHz}$		h_{ie}	6	8.7	15	k Ω
Output admittance (current gain group A)	$-V_{CE} = 5\text{ V}$, $-I_C = 2\text{ mA}$, $f = 1\text{ kHz}$		h_{oe}		18	30	μS



Parameter	Test condition	Part	Symbol	Min	Typ	Max	Unit
Output admittance (current gain group B)	- $V_{CE} = 5\text{ V}$, - $I_C = 2\text{ mA}$, $f = 1\text{ kHz}$		h_{oe}		30	60	μS
Output admittance (current gain group C)	- $V_{CE} = 5\text{ V}$, - $I_C = 2\text{ mA}$, $f = 1\text{ kHz}$		h_{oe}		60	110	μS
Reverse voltage transfer ratio (current gain group A)	- $V_{CE} = 5\text{ V}$, - $I_C = 2\text{ mA}$, $f = 1\text{ kHz}$		h_{re}		1.5×10^{-4}		
Reverse voltage transfer ratio (current gain group B)	- $V_{CE} = 5\text{ V}$, - $I_C = 2\text{ mA}$, $f = 1\text{ kHz}$		h_{re}		2×10^{-4}		
Reverse voltage transfer ratio (current gain group C)	- $V_{CE} = 5\text{ V}$, - $I_C = 2\text{ mA}$, $f = 1\text{ kHz}$		h_{re}		3×10^{-4}		
DC current gain (current gain group A)	- $V_{CE} = 5\text{ V}$, - $I_C = 10\text{ }\mu\text{A}$		h_{FE}		90		
DC current gain (current gain group B)	- $V_{CE} = 5\text{ V}$, - $I_C = 10\text{ }\mu\text{A}$		h_{FE}		150		
DC current gain (current gain group C)	- $V_{CE} = 5\text{ V}$, - $I_C = 10\text{ }\mu\text{A}$		h_{FE}		270		
DC current gain (current gain group A)	- $V_{CE} = 5\text{ V}$, - $I_C = 2\text{ mA}$		h_{FE}	110	180	220	
DC current gain (current gain group B)	- $V_{CE} = 5\text{ V}$, - $I_C = 2\text{ mA}$		h_{FE}	200	290	450	
DC current gain (current gain group C)	- $V_{CE} = 5\text{ V}$, - $I_C = 2\text{ mA}$		h_{FE}	420	520	800	
Collector saturation voltage	- $I_C = 10\text{ mA}$, - $I_B = 0.5\text{ mA}$		V_{CEsat}		90	300	mV
	- $I_C = 100\text{ mA}$, - $I_B = 5\text{ mA}$		V_{CEsat}		250	650	mV
Base saturation voltage	- $I_C = 10\text{ mA}$, - $I_B = 0.5\text{ mA}$		V_{BEsat}		700		mV
	- $I_C = 100\text{ mA}$, - $I_B = 5\text{ mA}$		V_{BEsat}		900		mV
Base - emitter voltage	- $V_{CE} = 5\text{ V}$, - $I_C = 2\text{ mA}$		V_{BE}	600	660	750	mV
	- $V_{CE} = 5\text{ V}$, - $I_C = 10\text{ mA}$		V_{BE}			820	mV
Collector-emitter cut-off current	- $V_{CE} = 80\text{ V}$	BC856	I_{CES}		0.2	15	nA
	- $V_{CE} = 50\text{ V}$	BC857	I_{CES}		0.2	15	nA
	- $V_{CE} = 30\text{ V}$	BC858	I_{CES}		0.2	15	nA
		BC859	I_{CES}		0.2	15	nA
	- $V_{CE} = 80\text{ V}$, $T_j = 125\text{ }^\circ\text{C}$	BC857	I_{CES}			4	μA
	- $V_{CE} = 50\text{ V}$, $T_j = 125\text{ }^\circ\text{C}$	BC857	I_{CES}			4	μA
	- $V_{CE} = 30\text{ V}$, $T_j = 125\text{ }^\circ\text{C}$	BC858	I_{CES}			4	μA
		BC859	I_{CES}			4	μA
Collector-base cut-off current	- $V_{CB} = 30\text{ V}$		I_{CBO}			15	μA
	- $V_{CB} = 30\text{ V}$, $T_j = 150\text{ }^\circ\text{C}$		I_{CBO}			5	μA

Electrical AC Characteristics

Parameter	Test condition	Part	Symbol	Min	Typ	Max	Unit
Gain bandwidth product	- $V_{CE} = 5\text{ V}$, - $I_C = 10\text{ mA}$, $f = 100\text{ MHz}$		f_T		150		MHz
Collector - base capacitance	- $V_{CB} = 10\text{ V}$, $f = 1\text{ MHz}$		C_{CBO}			6	pF
Noise figure	- $V_{CE} = 5\text{ V}$, - $I_C = 200\text{ }\mu\text{A}$, $R_G = 2\text{ k}\Omega$, $f = 1\text{ kHz}$, $\Delta f = 200\text{ Hz}$	BC856	F		2	10	dB
		BC857	F		2	10	dB
		BC858	F		2	10	dB
		BC859	F		1	4	dB
		- $V_{CE} = 5\text{ V}$, - $I_C = 200\text{ }\mu\text{A}$, $R_G = 2\text{ k}\Omega$, $f = (30\text{ to }15000)\text{ Hz}$	BC859	F		1.2	4

Layout for R_{thJA} test

Thickness: Fiberglass 1.5 mm (0.059 in.)

Copper leads 0.3 mm (0.012 in.)

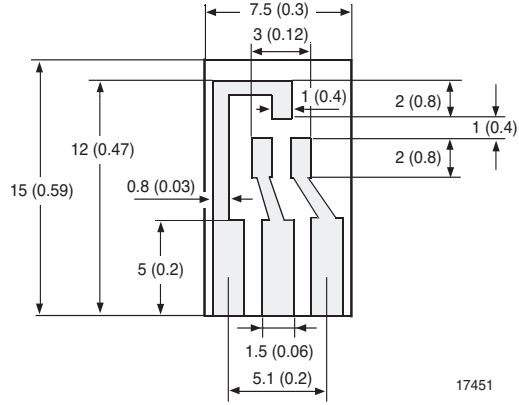

Typical Characteristics ($T_{amb} = 25\text{ }^{\circ}\text{C}$ unless otherwise specified)

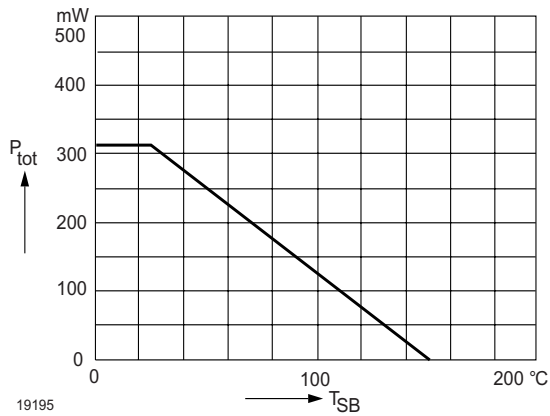

Figure 1. Admissible Power Dissipation vs. Temperature of Substrate Backside

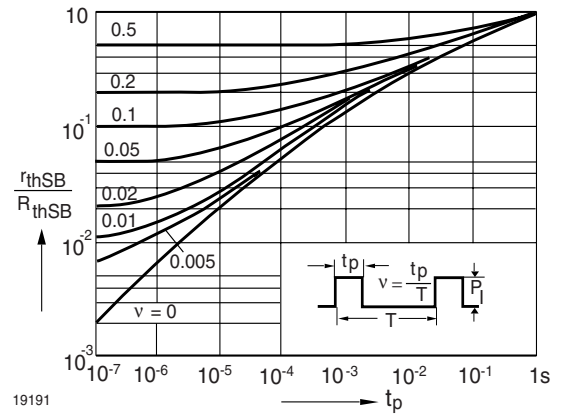

Figure 2. Pulse Thermal Resistance vs. Pulse Duration (normalized)

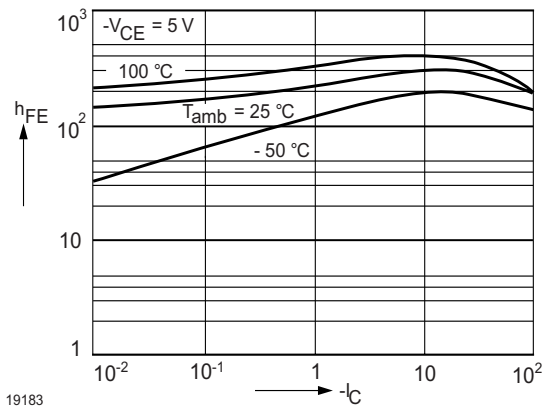

Figure 3. DC Current Gain vs. Collector Current

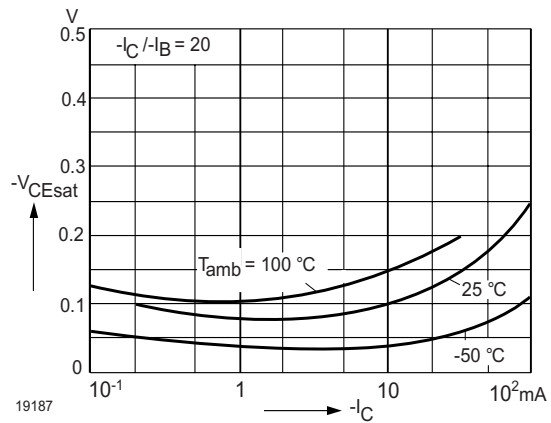

Figure 6. Collector Saturation Voltage vs. Collector Current

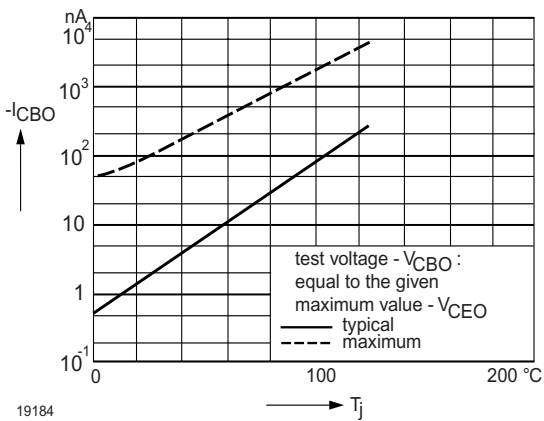

Figure 4. Collector-Base Cutoff Current vs. Ambient Temperature

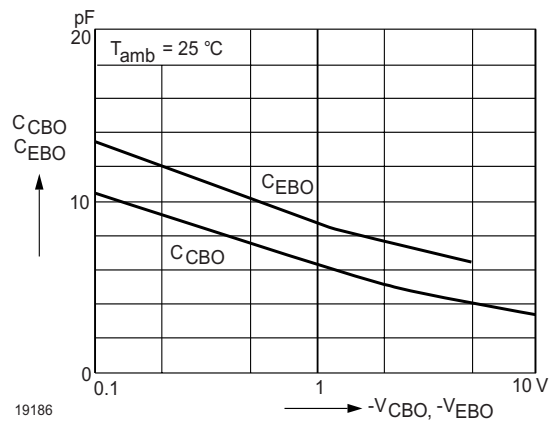

Figure 7. Collector Base Capacitance, Emitter base Capacitance vs. Bias Voltage

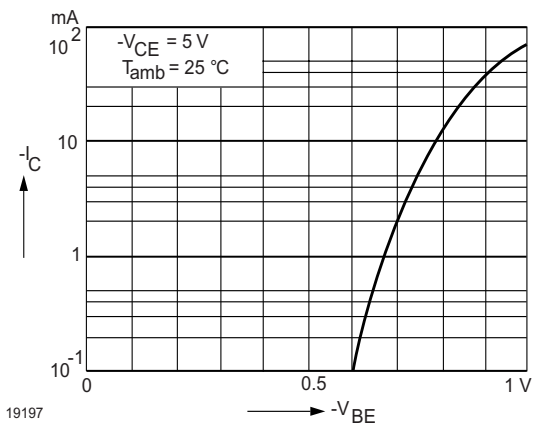

Figure 5. Collector Current vs. Base-Emitter Voltage

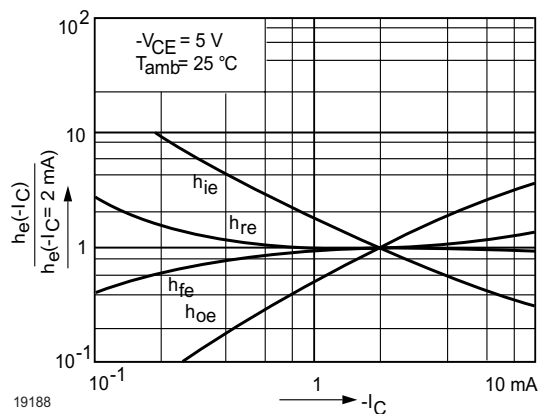

Figure 8. Relative h-Parameters vs. Collector Current

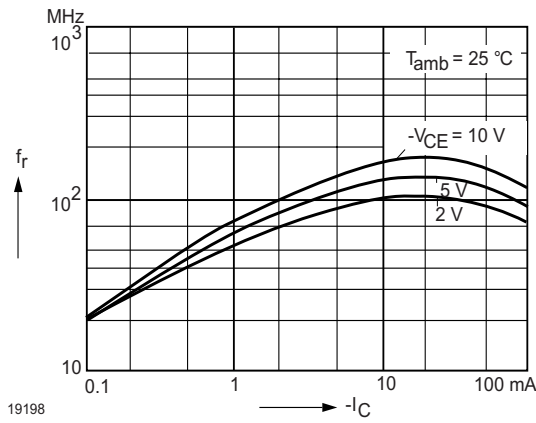

Figure 9. Gain-Bandwidth Product vs. Collector Current

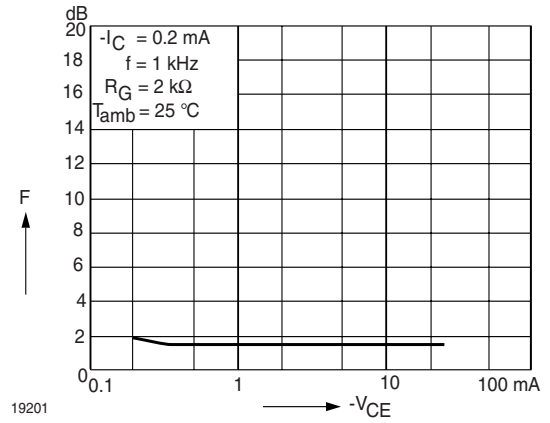

Figure 12. Noise Figure vs. Collector Emitter Voltage

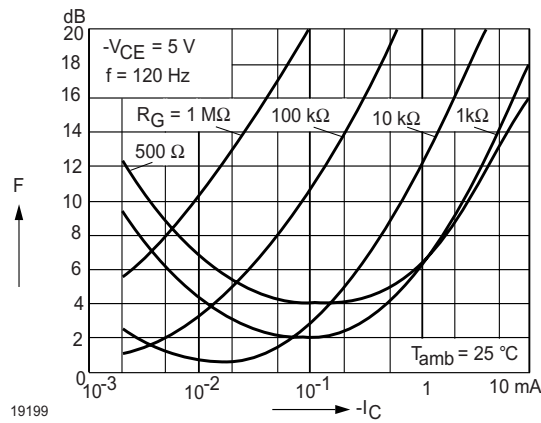

Figure 10. Noise Figure vs. Collector Current

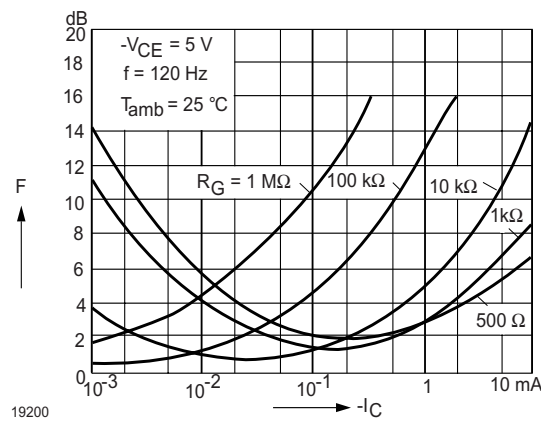

Figure 11. Noise Figure vs. Collector Current

BC856 to BC859

Vishay Semiconductors



Package Dimensions in mm (Inches)

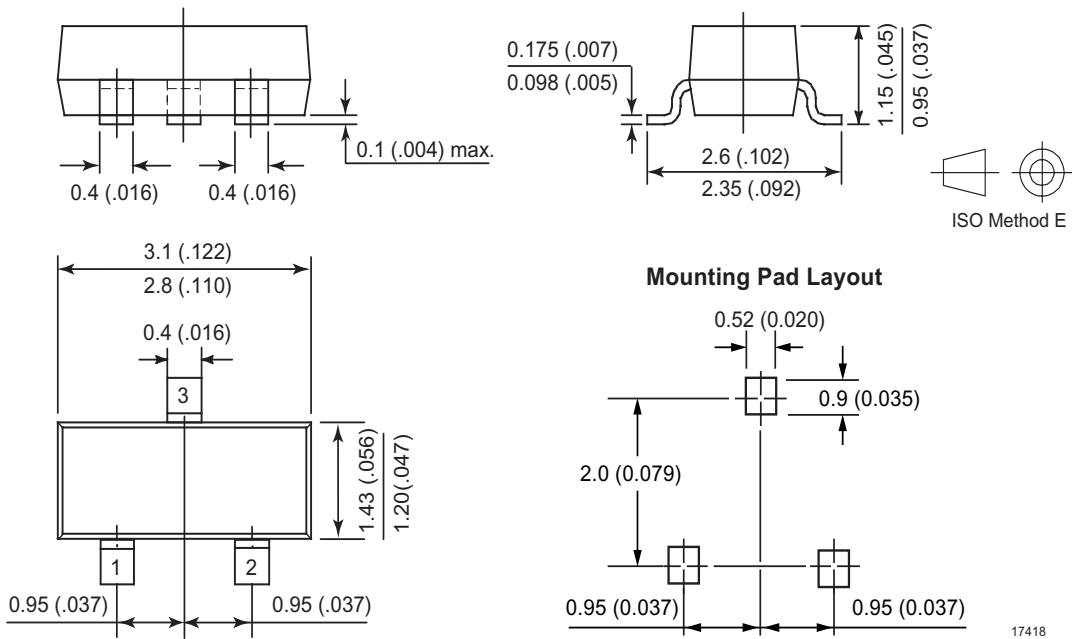



Ozone Depleting Substances Policy Statement

It is the policy of **Vishay Semiconductor GmbH** to

1. Meet all present and future national and international statutory requirements.
2. Regularly and continuously improve the performance of our products, processes, distribution and operating systems with respect to their impact on the health and safety of our employees and the public, as well as their impact on the environment.

It is particular concern to control or eliminate releases of those substances into the atmosphere which are known as ozone depleting substances (ODSs).

The Montreal Protocol (1987) and its London Amendments (1990) intend to severely restrict the use of ODSs and forbid their use within the next ten years. Various national and international initiatives are pressing for an earlier ban on these substances.

Vishay Semiconductor GmbH has been able to use its policy of continuous improvements to eliminate the use of ODSs listed in the following documents.

1. Annex A, B and list of transitional substances of the Montreal Protocol and the London Amendments respectively
2. Class I and II ozone depleting substances in the Clean Air Act Amendments of 1990 by the Environmental Protection Agency (EPA) in the USA
3. Council Decision 88/540/EEC and 91/690/EEC Annex A, B and C (transitional substances) respectively.

Vishay Semiconductor GmbH can certify that our semiconductors are not manufactured with ozone depleting substances and do not contain such substances.

**We reserve the right to make changes to improve technical design
and may do so without further notice.**

Parameters can vary in different applications. All operating parameters must be validated for each customer application by the customer. Should the buyer use Vishay Semiconductors products for any unintended or unauthorized application, the buyer shall indemnify Vishay Semiconductors against all claims, costs, damages, and expenses, arising out of, directly or indirectly, any claim of personal damage, injury or death associated with such unintended or unauthorized use.

Vishay Semiconductor GmbH, P.O.B. 3535, D-74025 Heilbronn, Germany
Telephone: 49 (0)7131 67 2831, Fax number: 49 (0)7131 67 2423