

Features

- For AF input stages and driver applications
- High current gain
- Low collector-emitter saturation voltage
- Low noise between 30 Hz and 15 kHz
- Complementary types: BC 846, BC 847, BC 849, BC 850 (NPN)

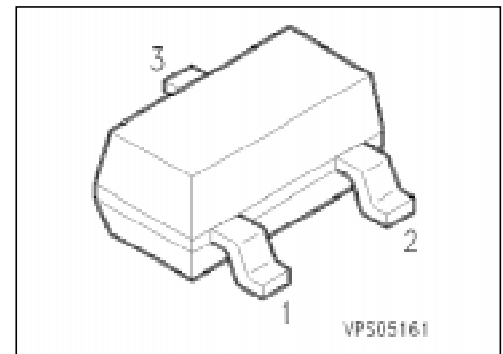

Type	Marking	Ordering Code (tape and reel)	Pin Configuration			Package ¹⁾
			1	2	3	
BC 856 A	3As	Q62702-C1773	B	E	C	SOT-23
BC 856 B	3Bs	Q62702-C1886				
BC 857 A	3Es	Q62702-C1850				
BC 857 B	3Fs	Q62702-C1688				
BC 857 C	3Gs	Q62702-C1851				
BC 858 A	3Js	Q62702-C1742				
BC 858 B	3Ks	Q62702-C1698				
BC 858 C	3Ls	Q62702-C1507				
BC 859 A	4As	Q62702-C1887				
BC 859 B	4Bs	Q62702-C1774				
BC 859 C	4Cs	Q62702-C1761				
BC 860 B	4Fs	Q62702-C1888				
BC 860 C	4Gs	Q62702-C1889				

¹⁾For detailed information see chapter Package Outlines.

Maximum Ratings

Parameter	Symbol	Values			Unit
		BC 856	BC 857 BC 860	BC 858 BC 859	
Collector-emitter voltage	V_{CE0}	65	45	30	V
Collector-base voltage	V_{CB0}	80	50	30	
Collector-emitter voltage	V_{CES}	80	50	30	
Emitter-base voltage	V_{EB0}	5	5	5	
Collector current	I_C	100			mA
Peak collector current	I_{CM}	200			
Peak base current	I_{BM}	200			
Peak emitter current	I_{EM}	200			
Total power dissipation, $T_s = 71\text{ °C}$	P_{tot}	330			mW
Junction temperature	T_j	150			°C
Storage temperature range	T_{stg}	- 65 ... + 150			

Thermal Resistance

Junction - ambient ¹⁾	$R_{th\ JA}$	≤ 310	K/W
Junction - soldering point	$R_{th\ JS}$	≤ 240	

¹⁾Package mounted on epoxy pcb 40 mm × 40 mm × 1.5 mm/6 cm² Cu.

Electrical Characteristics

at $T_A = 25\text{ °C}$, unless otherwise specified.

Parameter	Symbol	Values			Unit
		min.	typ.	max.	

DC characteristics

Collector-emitter breakdown voltage $I_C = 10\text{ mA}$ BC 856 BC 857, BC 860 BC 858, BC 859	$V_{(BR)CE0}$	65 45 30	— — —	— — —	V
Collector-base breakdown voltage $I_C = 10\text{ }\mu\text{A}$ BC 856 BC 857, BC 860 BC 858, BC 859	$V_{(BR)CB0}$	80 50 30	— — —	— — —	
Collector-emitter breakdown voltage $I_C = 10\text{ }\mu\text{A}$, $V_{BE} = 0$ BC 856 BC 857, BC 860 BC 858, BC 859	$V_{(BR)CES}$	80 50 30	— — —	— — —	
Emitter-base breakdown voltage $I_E = 1\text{ }\mu\text{A}$	$V_{(BR)EB0}$	5	—	—	
Collector cutoff current $V_{CB} = 30\text{ V}$ $V_{CB} = 30\text{ V}$, $T_A = 150\text{ °C}$	I_{CB0}	— —	1 —	15 4	nA μA
DC current gain $I_C = 10\text{ }\mu\text{A}$, $V_{CE} = 5\text{ V}$ BC 856 A ... BC 859 A BC 856 B ... BC 860 B BC 857 C ... BC 860 C $I_C = 2\text{ mA}$, $V_{CE} = 5\text{ V}$ BC 856 A ... BC 859 A BC 856 B ... BC 860 B BC 857 C ... BC 860 C	h_{FE}	— — — 125 220 420	140 250 480 180 290 520	— — — 250 475 800	—
Collector-emitter saturation voltage ¹⁾ $I_C = 10\text{ mA}$, $I_B = 0.5\text{ mA}$ $I_C = 100\text{ mA}$, $I_B = 5\text{ mA}$	V_{CEsat}	— —	75 250	300 650	mV
Base-emitter saturation voltage ¹⁾ $I_C = 10\text{ mA}$, $I_B = 0.5\text{ mA}$ $I_C = 100\text{ mA}$, $I_B = 5\text{ mA}$	V_{BEsat}	— —	700 850	— —	
Base-emitter voltage $I_C = 2\text{ mA}$, $V_{CE} = 5\text{ V}$ $I_C = 10\text{ mA}$, $V_{CE} = 5\text{ V}$	$V_{BE(on)}$	600 —	650 —	750 820	

¹⁾Pulse test: $t \leq 300\text{ }\mu\text{s}$, $D = 2\text{ %}$.

Electrical Characteristics

at $T_A = 25\text{ °C}$, unless otherwise specified.

Parameter	Symbol	Values			Unit
		min.	typ.	max.	

AC characteristics

Transition frequency $I_C = 20\text{ mA}$, $V_{CE} = 5\text{ V}$, $f = 100\text{ MHz}$	f_t	–	250	–	MHz
Output capacitance $V_{CB} = 10\text{ V}$, $f = 1\text{ MHz}$	C_{obo}	–	3	–	pF
Input capacitance $V_{CB} = 0.5\text{ V}$, $f = 1\text{ MHz}$	C_{ibo}	–	8	–	
Short-circuit input impedance $I_C = 2\text{ mA}$, $V_{CE} = 5\text{ V}$, $f = 1\text{ kHz}$ BC 856 A ... BC 859 A BC 856 B ... BC 860 B BC 857 C ... BC 860 C	h_{11e}	–	2.7 4.5 8.7	–	kΩ
Open-circuit reverse voltage transfer ratio $I_C = 2\text{ mA}$, $V_{CE} = 5\text{ V}$, $f = 1\text{ kHz}$ BC 856 A ... BC 859 A BC 856 B ... BC 860 B BC 857 C ... BC 860 C	h_{12e}	–	1.5 2.0 3.0	–	10^{-4}
Short-circuit forward current transfer ratio $I_C = 2\text{ mA}$, $V_{CE} = 5\text{ V}$, $f = 1\text{ kHz}$ BC 856 A ... BC 859 A BC 856 B ... BC 860 B BC 857 C ... BC 860 C	h_{21e}	–	200 330 600	–	–
Open-circuit output admittance $I_C = 2\text{ mA}$, $V_{CE} = 5\text{ V}$, $f = 1\text{ kHz}$ BC 856 A ... BC 859 A BC 856 B ... BC 860 B BC 857 C ... BC 860 C	h_{22e}	–	18 30 60	–	μS
Noise figure $I_C = 0.2\text{ mA}$, $V_{CE} = 5\text{ V}$, $R_S = 2\text{ kΩ}$ $f = 30\text{ Hz} \dots 15\text{ kHz}$ $f = 1\text{ kHz}$, $\Delta f = 200\text{ Hz}$ BC 859 BC 860 BC 859 BC 860	F	–	1.2 1.0 1.0 1.0	4 3 4 4	dB
Equivalent noise voltage $I_C = 0.2\text{ mA}$, $V_{CE} = 5\text{ V}$, $R_S = 2\text{ kΩ}$ $f = 10\text{ Hz} \dots 50\text{ Hz}$ BC 860	V_n	–	–	0.110	μV

Total power dissipation $P_{tot} = f(T_A^*; T_S)$
 * Package mounted on epoxy

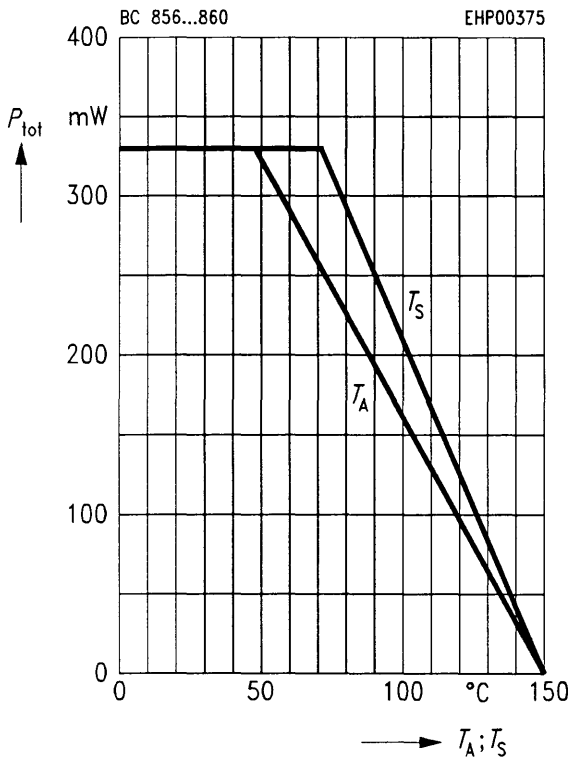

Collector-base capacitance $C_{CB0} = f(V_{CB0})$
Emitter-base capacitance $C_{EB0} = f(V_{EB0})$

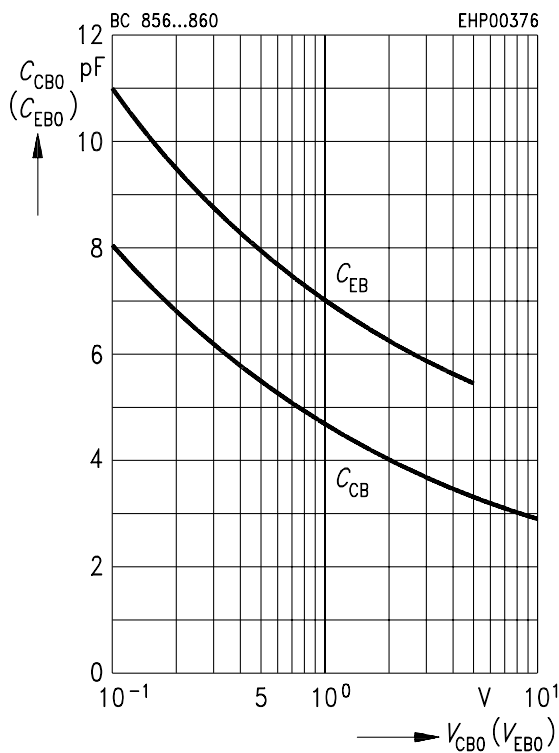

Permissible pulse load $P_{tot max}/P_{tot DC} = f(t_p)$

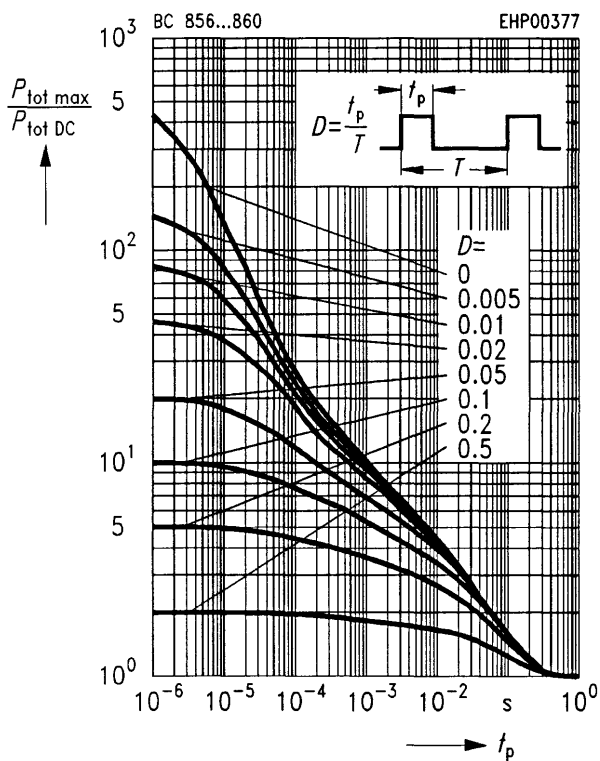

Transition frequency $f_T = f(I_C)$
 $V_{CE} = 5 V$

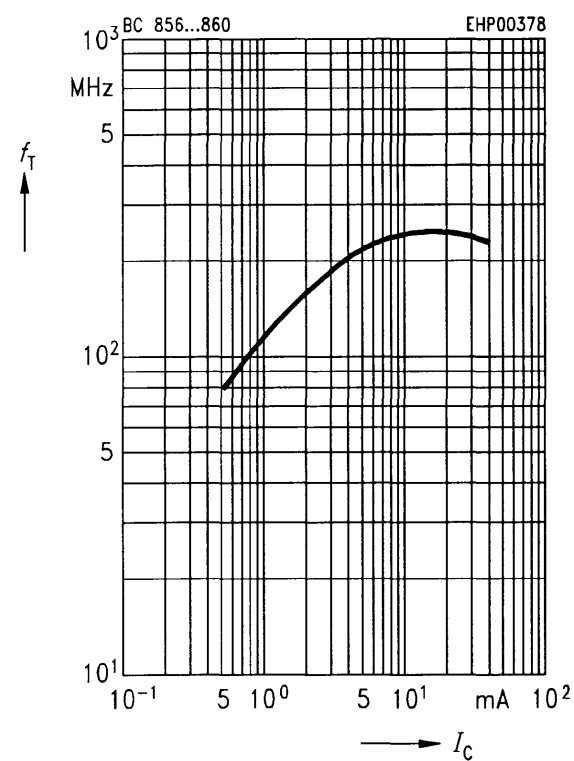

Collector cutoff current $I_{CB0} = f(T_A)$

$V_{CB} = 30\text{ V}$

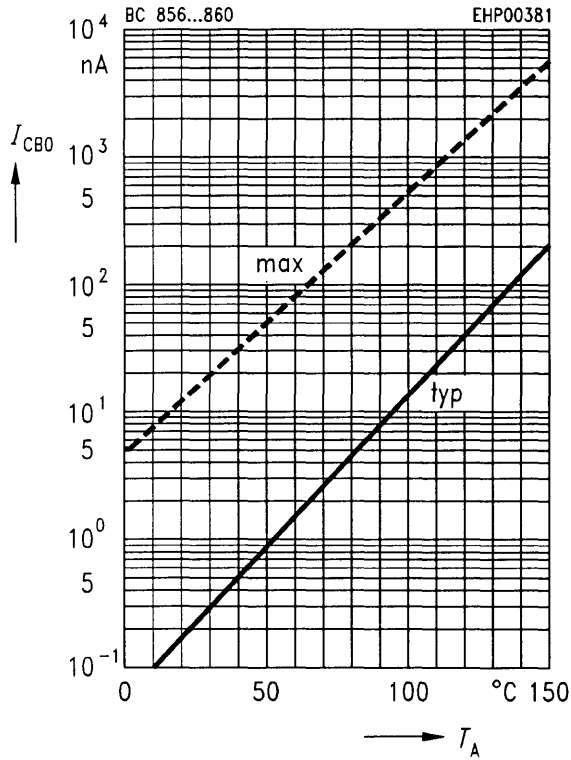

Collector-emitter saturation voltage

$I_C = f(V_{CEsat}), h_{FE} = 20$

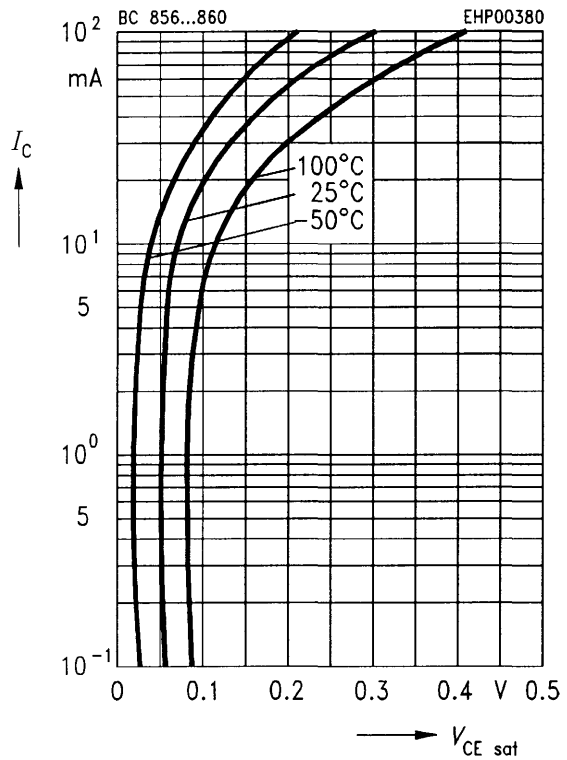

DC current gain $h_{FE} = f(I_C)$

$V_{CE} = 5\text{ V}$

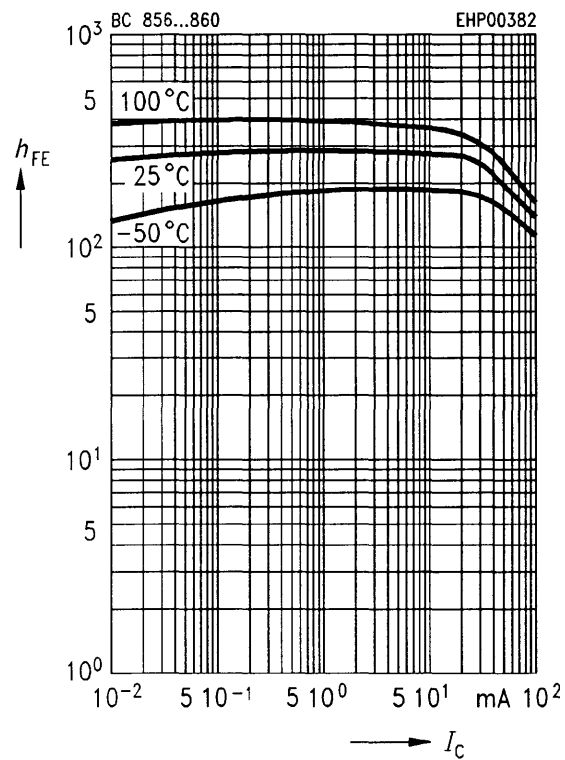

Base-emitter saturation voltage

$I_C = f(V_{BEsat}), h_{FE} = 20$

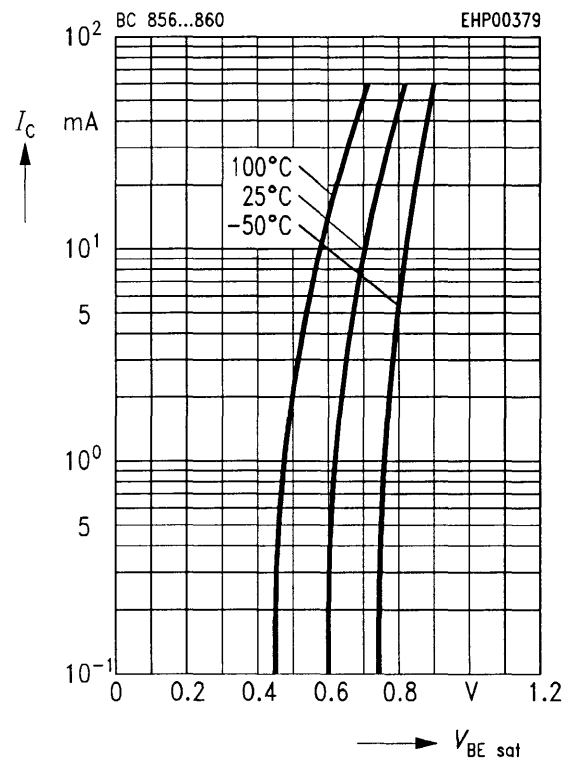

h parameter $h_e = f(I_C)$ normalized

$V_{CE} = 5\text{ V}$

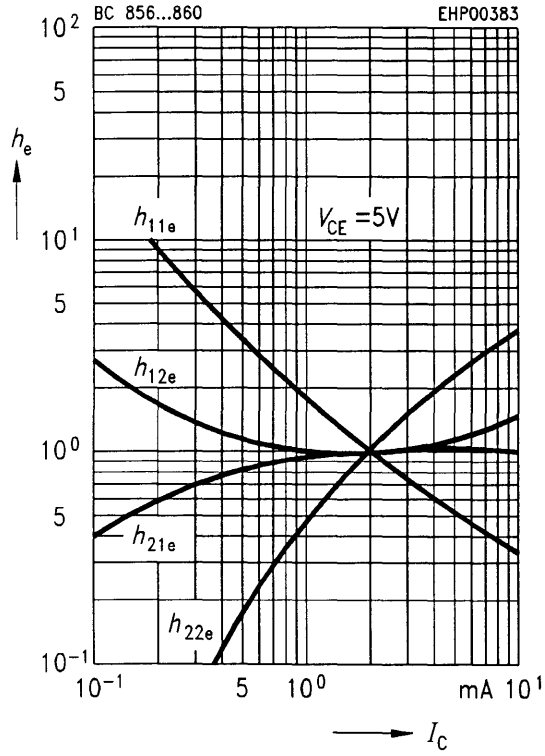

h parameter $h_e = f(V_{CE})$ normalized

$I_C = 2\text{ mA}$

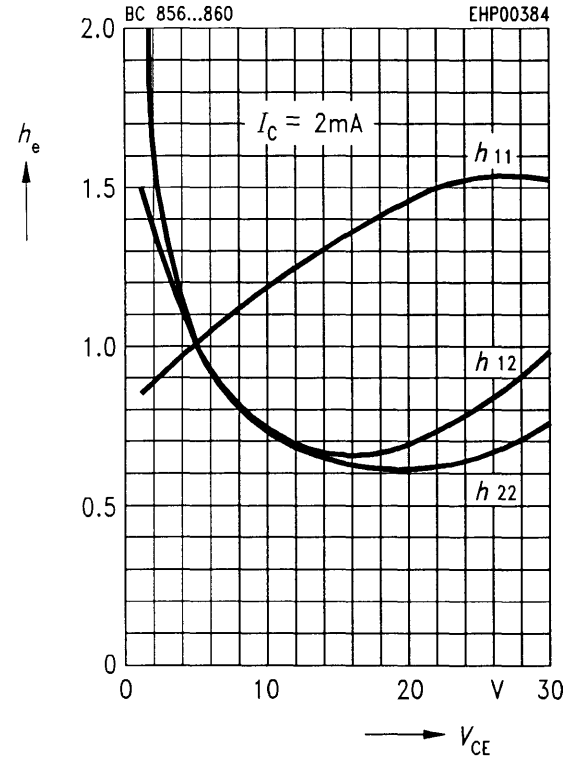

Noise figure $F = f(V_{CE})$

$I_C = 0.2\text{ mA}$, $R_S = 2\text{ k}\Omega$, $f = 1\text{ kHz}$

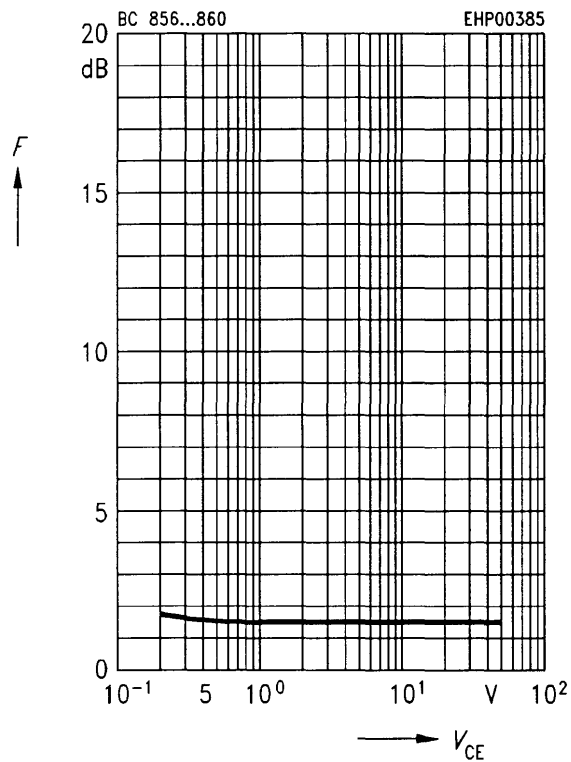

Noise figure $F = f(f)$

$I_C = 0.2\text{ mA}$, $R_S = 2\text{ k}\Omega$, $V_{CE} = 5\text{ V}$

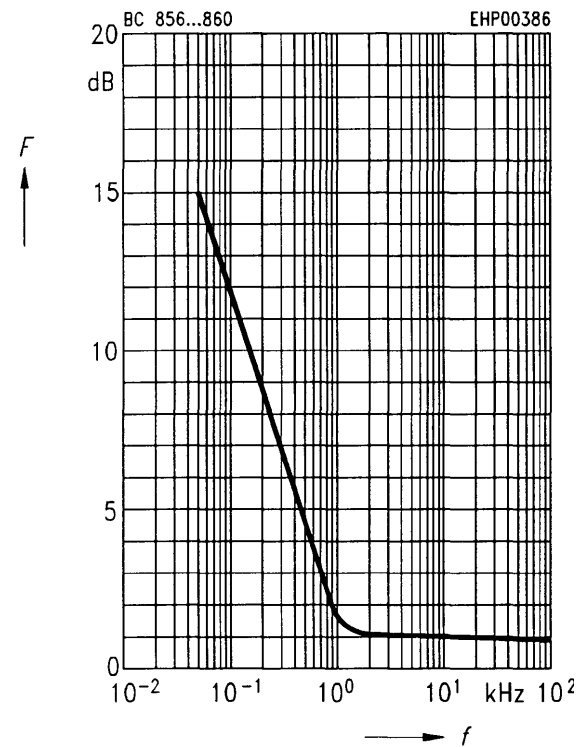

Noise figure $F = f(I_C)$

$V_{CE} = 5\text{ V}, f = 120\text{ Hz}$

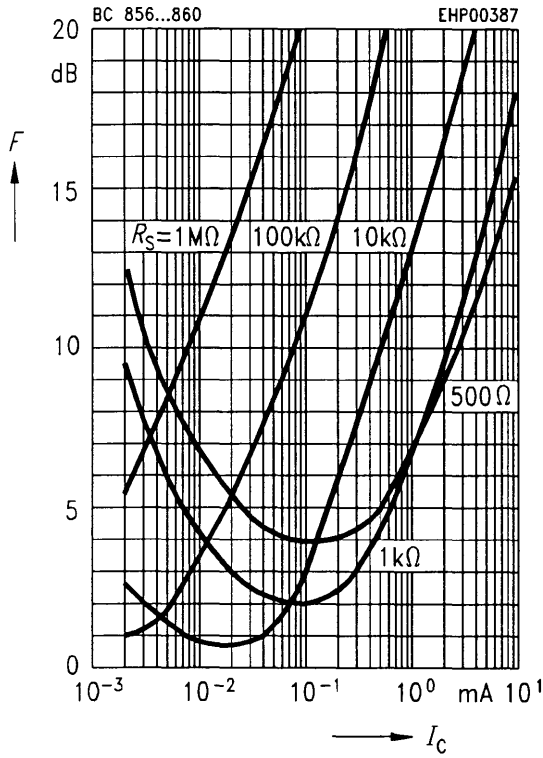

Noise figure $F = f(I_C)$

$V_{CE} = 5\text{ V}, f = 1\text{ kHz}$

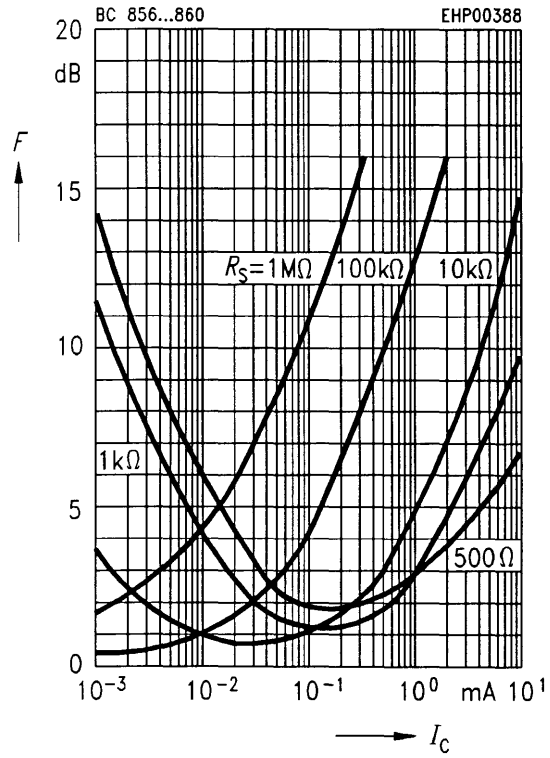

Noise figure $F = f(I_C)$

$V_{CE} = 5\text{ V}, f = 10\text{ kHz}$

