

BCR16A, BCR16B, BCR16C, BCR16E

MEDIUM POWER USE

A, B, C : NON-INSULATED TYPE, E : INSULATED TYPE, GLASS PASSIVATION TYPE

BCR16A, BCR16B, BCR16C, BCR16E



- I_T (RMS) 16A
- V_{DRM} 400V/500V
- IFGT I , IRGT I , IRGT III 30mA

OUTLINE DRAWING

Dimensions
in mm

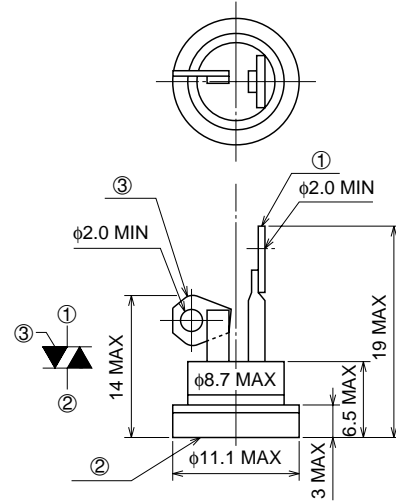

- ① T1 TERMINAL
- ② T2 TERMINAL
- ③ GATE TERMINAL

BCR16A

APPLICATION

Contactless AC switches, light dimmer, on/off and speed control of small induction motors, on/off control of traffic signals, on/off control of copier lamps, solid state relay, microwave ovens

MAXIMUM RATINGS

Symbol	Parameter	Voltage class		Unit
		8	10	
V_{DRM}	Repetitive peak off-state voltage *1	400	500	V
V_{DSM}	Non-repetitive peak off-state voltage *1	600	700	V

Symbol	Parameter	Conditions		Ratings	Unit
		BCR16A, B, C	BCR16E		
I_T (RMS)	RMS on-state current	Commercial frequency, sine full wave, 360° conduction	$T_c=99^\circ\text{C}$	16	A
I_{TSM}	Surge on-state current	60Hz sinewave 1 full cycle, peak value, non-repetitive		170	A
i^2_t	i^2_t for fusing	Value corresponding to 1 cycle of half wave 60Hz, surge on-state current		121	A ² s
PGM	Peak gate power dissipation			5	W
PG (AV)	Average gate power dissipation			0.5	W
VGM	Peak gate voltage			10	V
IGM	Peak gate current			2	A
T_j	Junction temperature			-20 ~ +125	°C

*1. Gate open.

BCR16A, BCR16B, BCR16C, BCR16E

MEDIUM POWER USE

A, B, C : NON-INSULATED TYPE, E : INSULATED TYPE, GLASS PASSIVATION TYPE

MAXIMUM RATINGS (continue)

Symbol	Parameter	Test conditions	Ratings	Unit
T _{stg}	Storage temperature		-20 ~ +125	°C
—	Weight (Typical value)	BCR16A	3.0	g
		BCR16B	8.5	
		BCR16C	8.5	
		BCR16E	9.5	
—	Soldering temperature	BCR16A only, 10 sec.	230	°C
—	Mounting torque	BCR16C only (Typical value)	30	kg-cm
			2.94	N-m
V _{iso}	Isolated voltage	BCR16E only, T _a =25°C, AC 1 minute, T ₂ Terminal to base	1500	V

ELECTRICAL CHARACTERISTICS

Symbol	Parameter	Test conditions	Limits			Unit	
			Min.	Typ.	Max.		
I _{DRM}	Repetitive peak off-state current	T _j =125°C, V _{DRM} applied	—	—	3.0	mA	
V _{TM}	On-state voltage	T _c =25°C, T _b =25°C (BCR16E only), I _{TM} =25A, Instantaneous measurement	—	—	1.6	V	
V _{FGT I}	Gate trigger voltage *2	T _j =25°C, V _D =6V, R _L =6Ω, R _G =330Ω	I	—	—	1.5	V
V _{RGT I}			II	—	—	1.5	V
V _{RGT III}			III	—	—	1.5	V
I _{FGT I}	Gate trigger current *2	T _j =25°C, V _D =6V, R _L =6Ω, R _G =330Ω	I	—	—	30	mA
I _{RGT I}			II	—	—	30	mA
I _{RGT III}			III	—	—	30	mA
V _{GD}	Gate non-trigger voltage	T _j =125°C, V _D =1/2V _{DRM}	0.2	—	—	V	
R _{th (j-c)}	Thermal resistance	Junction to case (BCR16A, BCR16B, BCR16C)	—	—	1.2	°C/W	
R _{th (j-b)}		Junction to base (BCR16E)	—	—	2.5	°C/W	
(dv/dt) _c	Critical-rate of rise of off-state commutating voltage		*3	—	—	V/μs	

*2. Measurement using the gate trigger characteristics measurement circuit.

*3. The critical-rate of rise of the off-state commutating voltage is shown in the table below.

Voltage class	V _{DRM} (V)	(dv/dt) _c			Test conditions	Commutating voltage and current waveforms (inductive load)
		Symbol	Min.	Unit		
8	400	R	—	V/μs	1. Junction temperature T _j =125°C 2. Rate of decay of on-state commutating current (di/dt) _c =-8A/ms 3. Peak off-state voltage V _D =400V	
		L	10			
10	500	R	—			
		L	10			

BCR16A, BCR16B, BCR16C, BCR16E

MEDIUM POWER USE

A, B, C : NON-INSULATED TYPE, E : INSULATED TYPE, GLASS PASSIVATION TYPE

OUTLINE DRAWING

Dimensions in mm

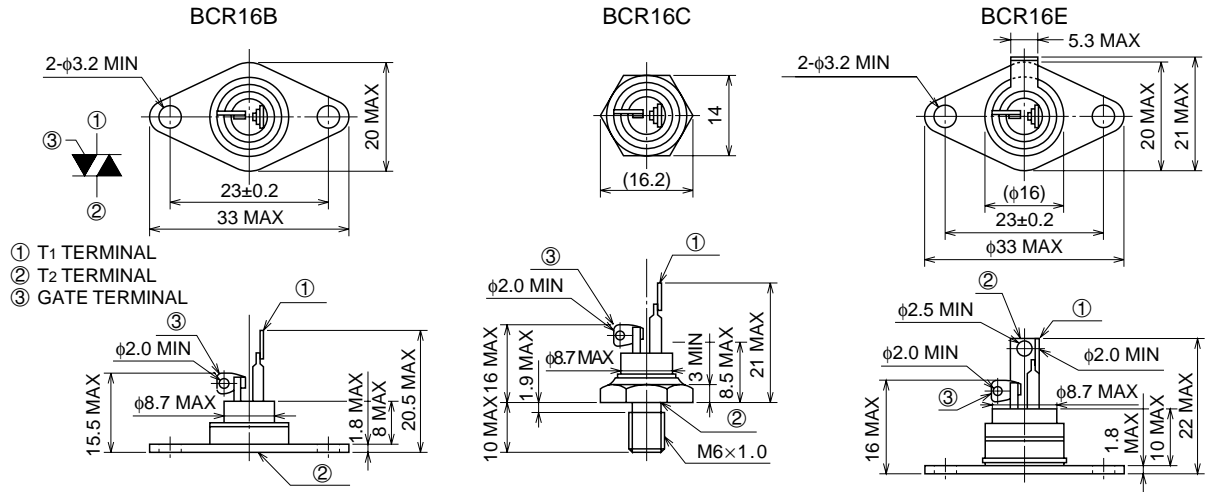

PERFORMANCE CURVES

MAXIMUM ON-STATE CHARACTERISTICS

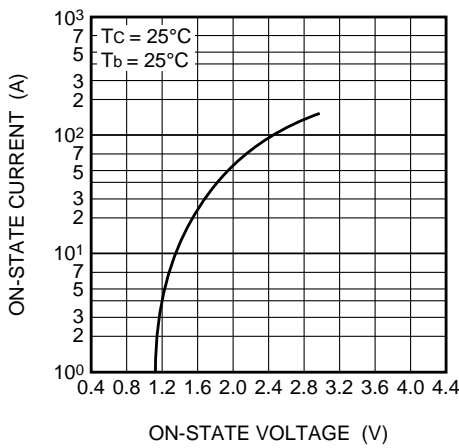

RATED SURGE ON-STATE CURRENT

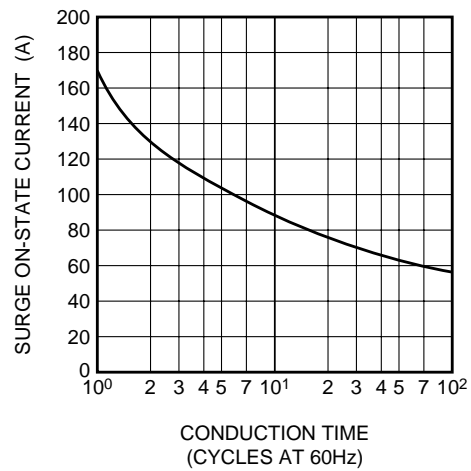

GATE CHARACTERISTICS

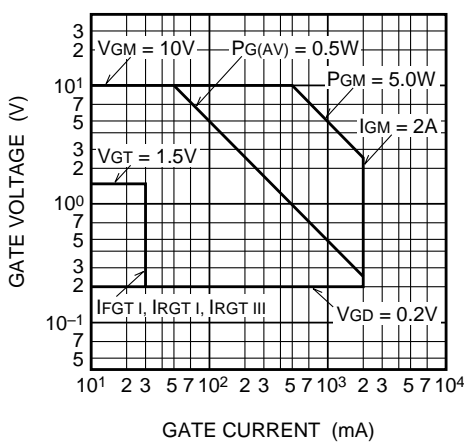

GATE TRIGGER CURRENT-VOLTAGE VS. JUNCTION TEMPERATURE

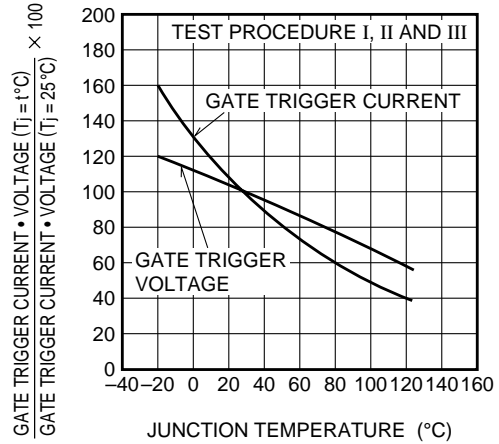

BCR16A, BCR16B, BCR16C, BCR16E

MEDIUM POWER USE

A, B, C : NON-INSULATED TYPE, E : INSULATED TYPE, GLASS PASSIVATION TYPE

MAXIMUM TRANSIENT THERMAL IMPEDANCE CHARACTERISTICS (JUNCTION TO CASE) (BCR16A, B, C)

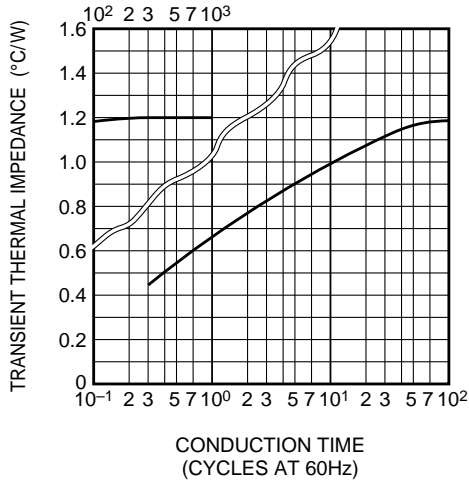

MAXIMUM TRANSIENT THERMAL IMPEDANCE CHARACTERISTICS (JUNCTION TO BASE) (BCR16E)

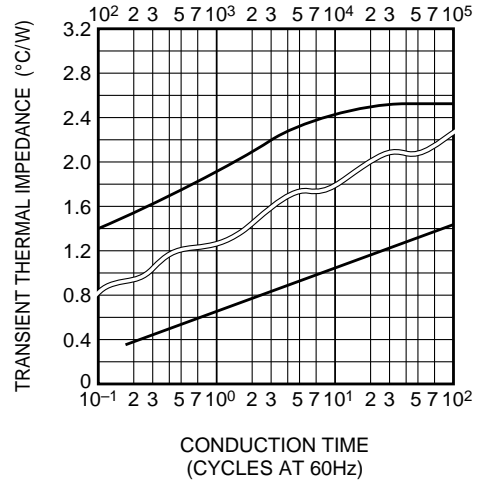

MAXIMUM ON-STATE POWER DISSIPATION

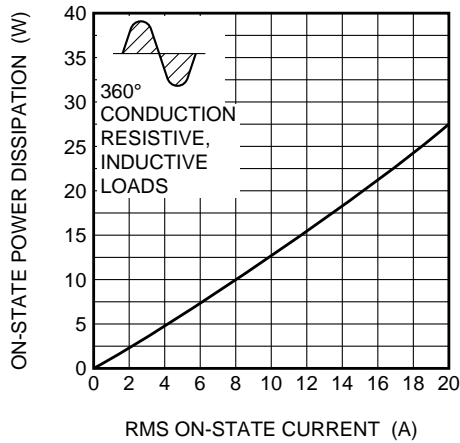

ALLOWABLE CASE TEMPERATURE VS. RMS ON-STATE CURRENT

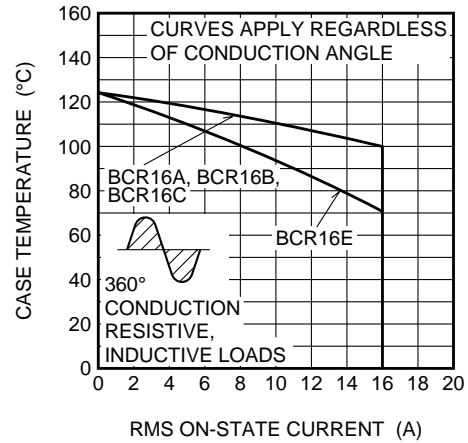

ALLOWABLE AMBIENT TEMPERATURE VS. RMS ON-STATE CURRENT (BCR16A)

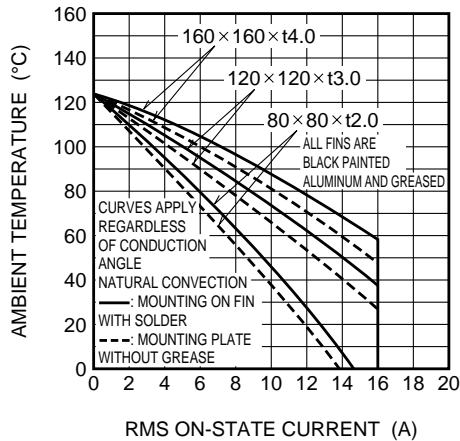

ALLOWABLE AMBIENT TEMPERATURE VS. RMS ON-STATE CURRENT (BCR16B)

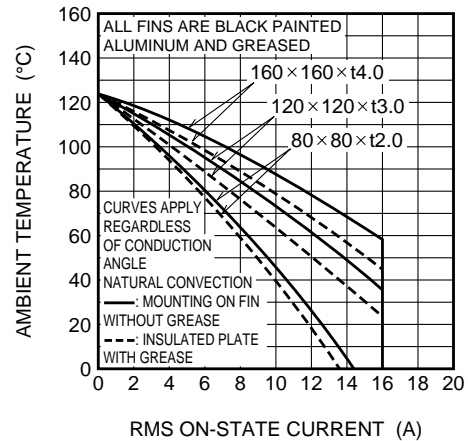

BCR16A, BCR16B, BCR16C, BCR16E

MEDIUM POWER USE

A, B, C : NON-INSULATED TYPE, E : INSULATED TYPE, GLASS PASSIVATION TYPE

ALLOWABLE AMBIENT TEMPERATURE VS. RMS ON-STATE CURRENT (BCR16C)

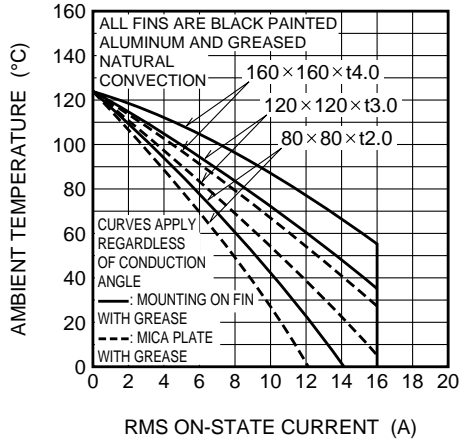

ALLOWABLE AMBIENT TEMPERATURE VS. RMS ON-STATE CURRENT (BCR16E)

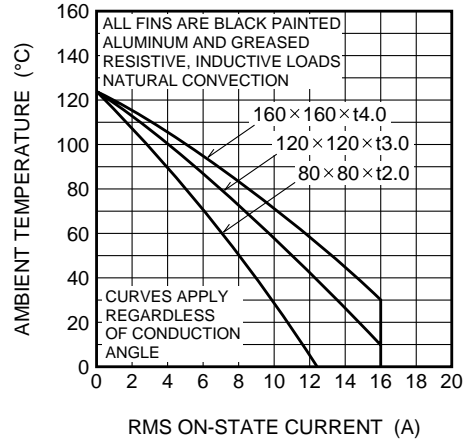

GATE TRIGGER CHARACTERISTICS TEST CIRCUITS

