

Isolated Triac 5 Amperes/400-600 Volts

OUTLINE DRAWING

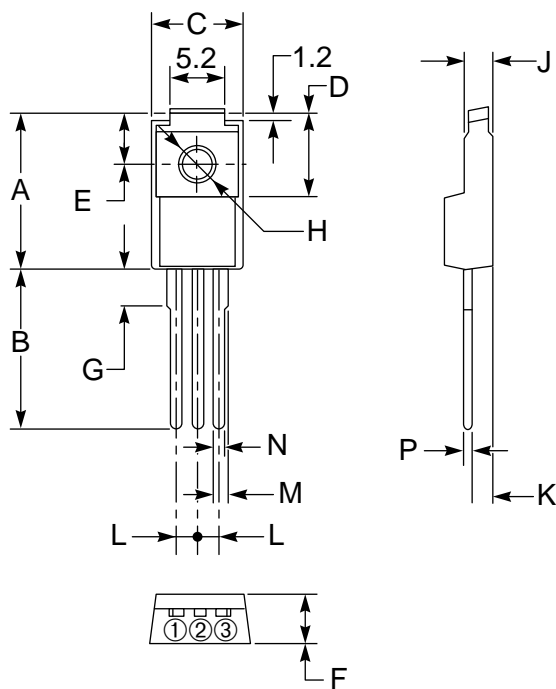

CONNECTION DIAGRAM

- ① T1 TERMINAL
- ② T2 TERMINAL
- ③ GATE TERMINAL

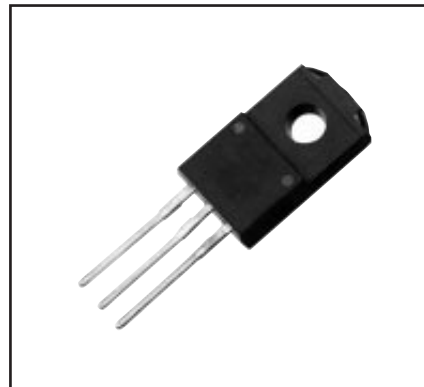
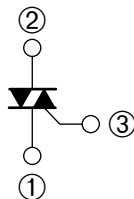

Description:

A triac is a solid state silicon AC switch which may be gate triggered from an off-state to an on-state for either polarity of applied voltage.

Features:

- Full Molded Isolation Package
- Glass Passivation
- 1500 V_{RMS} Isolation Voltage
UL Card
- Selected for Inductive Loads

Applications:

- AC Switch
- Motor Controls
- Lighting

Ordering Information:

Example: Select the complete seven, eight or nine digit part number you desire from the table - i.e. BCR5PM-8 is a 400 Volt, 5 Ampere Triac.

Outline Drawing (Conforms to TO-220F)

Dimensions	Inches	Millimeters
A	0.67	17.0
B	0.49 Min.	12.5 Min.
C	0.39	10.0
D	0.33	8.5
E	0.20	5.0
F	0.18	4.5
G	0.14	3.6

Dimensions	Inches	Millimeters
H	0.126 ± 0.008 Dia.	3.2 ± 0.2 Dia.
J	0.11	2.8
K	0.102	2.6
L	0.10	2.5
M	0.039	1.0
N	0.031	0.8
P	0.020	0.5

Type	V _{DRM} Volts	Code	Inductive Load*
BCR5PM	400 600	-8 -12	L

*For inductive load, add L.



Powerex, Inc., 200 Hillis Street, Youngwood, Pennsylvania 15697-1800 (412) 925-7272

BCR5PM

Isolated Triac

5 Amperes/400-600 Volts

Absolute Maximum Ratings, $T_a = 25\text{ }^\circ\text{C}$ unless otherwise specified

Ratings	Symbol	BCR5PM-8	BCR5PM-12	Units
Repetitive Peak Off-state Voltage	V_{DRM}	400	600	Volts
Non-repetitive Peak Off-state Voltage	V_{DSM}	500	720	Volts
On-state Current, $T_c = 95^\circ\text{C}$	$I_{T(RMS)}$	5	5	Amperes
Non-repetitive Peak Surge, One Cycle (60 Hz)	I_{TSM}	50	50	Amperes
I^2t for Fusing, $t = 8.3\text{ msec}$	I^2t	10.4	10.4	A^2sec
Peak Gate Power Dissipation, 20 μsec	P_{GM}	3	3	Watts
Average Gate Power Dissipation	$P_{G(avg)}$	0.3	0.3	Watts
Peak Gate Current	I_{GM}	2	2	Amperes
Peak Gate Voltage	V_{GM}	10	10	Volts
Storage Temperature	T_{stg}	-40 to 125	-40 to 125	$^\circ\text{C}$
Operating Junction Temperature	T_j	-40 to 125	-40 to 125	$^\circ\text{C}$
Isolation Voltage applied for one minute, terminal-to-case	V_{iso}	1500	1500	Volts
Weight	–	2	2	Grams

BCR5PM

Isolated Triac

5 Amperes/400-600 Volts

Electrical and Thermal Characteristics, $T_j = 25\text{ }^\circ\text{C}$ unless otherwise specified

Characteristics	Symbol	Test Conditions (Trigger Mode)			BCR5PM			Units
		V_D	R_L	T_j	Min.	Typ.	Max.	
Gate Parameters								
DC Gate Trigger Current								
MT2+ Gate+	I_{GT}	6V	6 Ω	25 $^\circ\text{C}$	–	–	20	mA
MT2+ Gate–		6V	6 Ω	25 $^\circ\text{C}$	–	–	20	mA
MT2– Gate–		6V	6 Ω	25 $^\circ\text{C}$	–	–	20	mA
DC Gate Trigger Voltage								
MT2+ Gate+	V_{GT}	6V	6 Ω	25 $^\circ\text{C}$	–	–	1.5	Volts
MT2+ Gate–		6V	6 Ω	25 $^\circ\text{C}$	–	–	1.5	Volts
MT2– Gate–		6V	6 Ω	25 $^\circ\text{C}$	–	–	1.5	Volts
DC Gate Non-trigger Voltage								
All	V_{GD}	1/2 V_{DRM}	–	125 $^\circ\text{C}$	0.2	–	–	Volts

BCR5PM

Isolated Triac

5 Amperes/400-600 Volts

Electrical and Thermal Characteristics, $T_j = 25^\circ\text{C}$ unless otherwise specified

Characteristics	Symbol	Test Conditions	Min.	Typ.	Max.	Units
Thermal Resistance, Junction-to-case	$R_{th(j-c)}$	–	–	–	4	$^\circ\text{C/W}$
Steady State Thermal Resistance, Junction-to-ambient	$R_{th(j-a)}$	–	–	–	60	$^\circ\text{C/W}$
Voltage – Blocking State Repetitive Off-state Current	I_{DRM}	Gate Open Circuited, $V_D = V_{DRM}$, $T_j = 125^\circ\text{C}$	–	–	2	mA
Current – Conducting State Peak On-state Voltage	V_{TM}	$T_C = 25^\circ\text{C}$, 8.3ms Pulsewidth Duty Cycle <2%, $I_{TM} = 7\text{A}$ Peak	–	–	1.8	Volts
DC Holding Current	I_H	Main Terminal Source Voltage = 75Vdc, Peak Initiating On-state Current = 1A, $T_j = 25^\circ\text{C}$	–	30	–	MA
Critical Rate-of-rise of Commutating Off-state Voltage (Commutating dv/dt) ▲ for inductive load (L) (Switching)	$(dv/dt)_c$	–	–	–	–	$\text{V}/\mu\text{s}$

Δ Part Number	V_{DRM} (Volts)	Load Type	Commutating $dv/dt, (dv/dt)_c$ ($\text{V}/\mu\text{sec}$)		Test Condition	Commutating Voltage & Current Waveform (Inductive Load)
			Minimum			
BCR5PM-8L	400	L	5		$T_j = 125^\circ\text{C}$,	
BCR5PM-12L	600	L	5		Rate of Decay On-state Commutating Current $(di/dt)_c = -2.5\text{A/msec}$; Peak Off-state Voltage $V_D = 400\text{V}$	

BCR5PM

Isolated Triac

5 Amperes/400-600 Volts

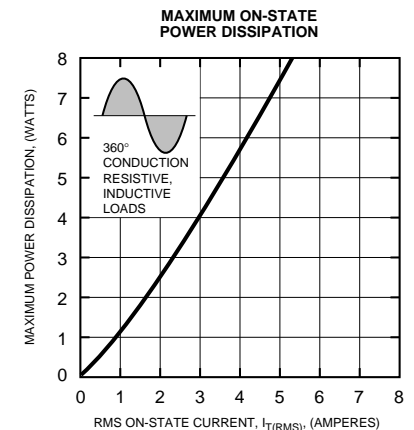
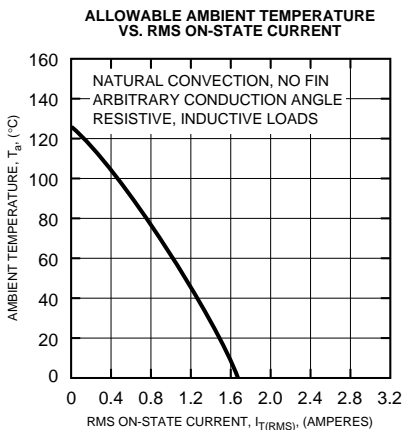
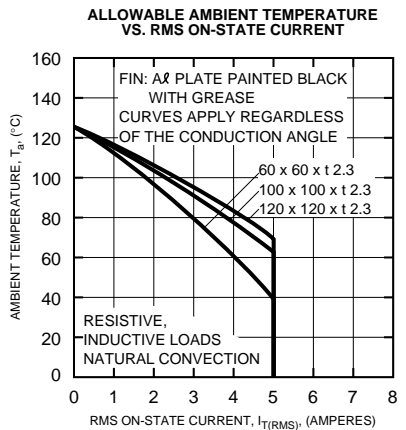
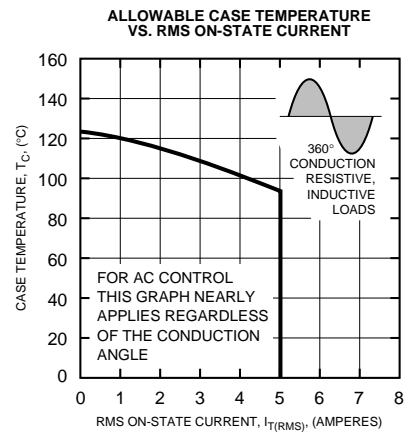
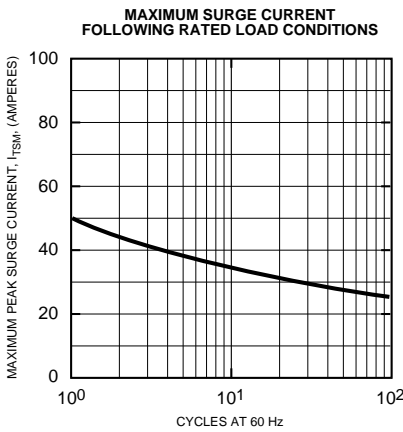
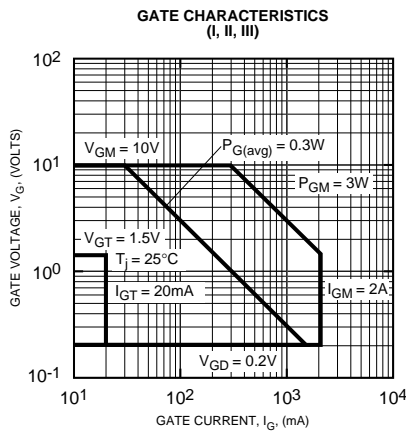
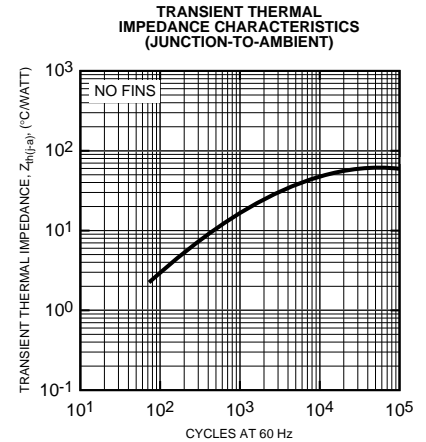
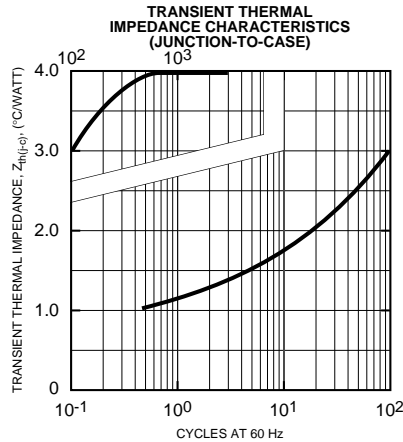
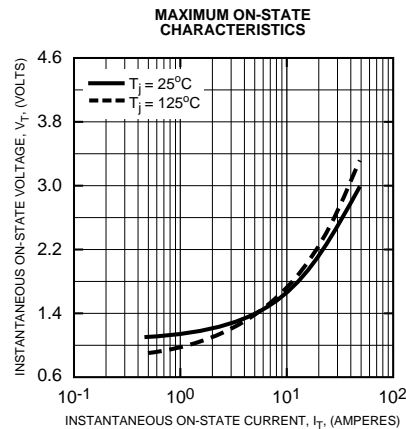

BCR5PM
Isolated Triac
 5 Amperes/400-600 Volts

