

PNP Silicon AF Transistors

BCX 78
BCX 79

- High current gain
- Low collector-emitter saturation voltage
- Low noise at 1 kHz
- Low noise at low frequencies
- Complementary types: BCX 58, BCX 59 (NPN)

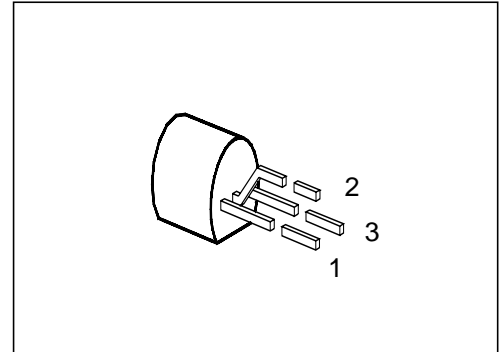

Type	Marking	Ordering Code	Pin Configuration			Package ¹⁾
			1	2	3	
BCX 78	—	Q62702-C717	C	B	E	TO-92
BCX 78-VII		Q62702-C626				
BCX 78-VIII		Q62702-C627				
BCX 78-IX		Q62702-C628				
BCX 78-X		Q62702-C629				
BCX 79		Q62702-C718				
BCX 79-VII		Q62702-C630				
BCX 79-VIII		Q62702-C631				
BCX 79-IX		Q62702-C632				
BCX 79-X		Q62702-C633				

¹⁾ For detailed information see chapter Package Outlines.

Maximum Ratings

Parameter	Symbol	Values		Unit
		BCX 78	BCX 79	
Collector-emitter voltage	V_{CE0}	32	45	V
Collector-base voltage	V_{CB0}	32	45	
Emitter-base voltage	V_{EB0}	5		
Collector current	I_C	100		mA
Peak collector current	I_{CM}	200		
Peak base current	I_{BM}	200		
Total power dissipation, $T_C = 70\text{ °C}$	P_{tot}	500		mW
Junction temperature	T_j	150		°C
Storage temperature range	T_{stg}	- 65 ... + 150		

Thermal Resistance

Junction - ambient	$R_{th JA}$	≤ 250	K/W
Junction - case ¹⁾	$R_{th JC}$	≤ 160	

¹⁾ Mounted on Al heat sink 15 mm × 25 mm × 0.5 mm.

Electrical Characteristics

at $T_A = 25\text{ }^\circ\text{C}$, unless otherwise specified.

Parameter	Symbol	Values			Unit
		min.	typ.	max.	

DC characteristics

Collector-emitter breakdown voltage $I_C = 2\text{ mA}$	$V_{(BR)CE0}$	32 45	– –	– –	V
Collector-base breakdown voltage $I_C = 10\text{ }\mu\text{A}$	$V_{(BR)CB0}$	32 45	– –	– –	
Emitter-base breakdown voltage $I_E = 1\text{ }\mu\text{A}$	$V_{(BR)EB0}$	5	–	–	
Collector cutoff current $V_{CB} = 32\text{ V}$ $V_{CB} = 45\text{ V}$ $V_{CB} = 32\text{ V}, T_A = 150\text{ }^\circ\text{C}$ $V_{CB} = 45\text{ V}, T_A = 150\text{ }^\circ\text{C}$	I_{CB0}	– – – –	– – – –	20 20 10 10	nA nA μA μA
Collector cutoff current $V_{CB} = 32\text{ V}, V_{BE} = 0.2\text{ V}, T_A = 100\text{ }^\circ\text{C}$ $V_{CB} = 45\text{ V}, V_{BE} = 0.2\text{ V}, T_A = 100\text{ }^\circ\text{C}$	I_{CE0}	– –	– –	20 20	μA
Emitter cutoff current $V_{EB} = 4\text{ V}$	I_{EB0}	–	–	20	nA
DC current gain $I_C = 10\text{ }\mu\text{A}, V_{CE} = 5\text{ V}$	h_{FE}	20 30 40 100	140 200 270 340	– – – –	–
$I_C = 2\text{ mA}, V_{CE} = 5\text{ V}$		120 180 250 380	170 250 350 500	220 310 460 630	
$I_C = 100\text{ mA}, V_{CE} = 1\text{ V}^{1)}$		40 45 60 60	– – – –	– – – –	

¹⁾ Pulse test: $t \leq 300\text{ }\mu\text{s}, D \leq 2\%$.

Electrical Characteristics

at $T_A = 25\text{ }^\circ\text{C}$, unless otherwise specified.

Parameter	Symbol	Values			Unit
		min.	typ.	max.	

DC characteristics

Collector-emitter saturation voltage ¹⁾ $I_C = 100\text{ mA}$, $I_B = 2.5\text{ mA}$	V_{CEsat}	–	–	0.6	V
Base-emitter saturation voltage ¹⁾ $I_C = 100\text{ mA}$, $I_B = 2.5\text{ mA}$	V_{BEsat}	–	–	1.0	
Base-emitter voltage $I_C = 10\text{ }\mu\text{A}$, $V_{CE} = 5\text{ V}$ $I_C = 2\text{ mA}$, $V_{CE} = 5\text{ V}$ $I_C = 100\text{ mA}$, $V_{CE} = 1\text{ V}$ ¹⁾	$V_{BE(on)}$	– 0.55 –	0.52 0.65 0.93	– 0.75 –	

¹⁾ Pulse test: $t \leq 300\text{ }\mu\text{s}$, $D \leq 2\text{ }\%$.

Electrical Characteristics

at $T_A = 25\text{ }^\circ\text{C}$, unless otherwise specified.

Parameter	Symbol	Values			Unit		
		min.	typ.	max.			
AC characteristics							
Transition frequency $I_C = 20\text{ mA}$, $V_{CE} = 5\text{ V}$, $f = 100\text{ MHz}$	f_T	–	250	–	MHz		
Output capacitance $V_{CB} = 10\text{ V}$, $f = 1\text{ MHz}$	C_{obo}	–	3	–	pF		
Input capacitance $V_{EB} = 0.5\text{ V}$, $f = 1\text{ MHz}$	C_{ibo}	–	10	–			
Short-circuit input impedance $I_C = 2\text{ mA}$, $V_{CE} = 5\text{ V}$, $f = 1\text{ kHz}$ BCX 78 VII, BCX 79 VII BCX 78 VIII, BCX 79 VIII BCX 78 IX, BCX 79 IX BCX 78 X, BCX 79 X	h_{11e}	–	2.7 3.6 4.5 7.5	–	k Ω		
Open-circuit reverse voltage transfer ratio $I_C = 2\text{ mA}$, $V_{CE} = 5\text{ V}$, $f = 1\text{ kHz}$ BCX 78 VII, BCX 79 VII BCX 78 VIII, BCX 79 VIII BCX 78 IX, BCX 79 IX BCX 78 X, BCX 79 X	h_{12e}	–	1.5 2 2 3	–		10^{-4}	
Short-circuit forward current transfer ratio $I_C = 2\text{ mA}$, $V_{CE} = 5\text{ V}$, $f = 1\text{ kHz}$ BCX 78 VII, BCX 79 VII BCX 78 VIII, BCX 79 VIII BCX 78 IX, BCX 79 IX BCX 78 X, BCX 79 X	h_{21e}	–	200 260 330 520	–			–
Open-circuit output admittance $I_C = 2\text{ mA}$, $V_{CE} = 5\text{ V}$, $f = 1\text{ kHz}$ BCX 78 VII, BCX 79 VII BCX 78 VIII, BCX 79 VIII BCX 78 IX, BCX 79 IX BCX 78 X, BCX 79 X	h_{22e}	–	18 24 30 50	–			
Noise figure $I_C = 0.2\text{ mA}$, $V_{CE} = 5\text{ V}$, $R_S = 2\text{ k}\Omega$ $f = 1\text{ kHz}$, $\Delta f = 200\text{ Hz}$	F	–	2	–	dB		

Total power dissipation $P_{tot} = f(T_A; T_C)$

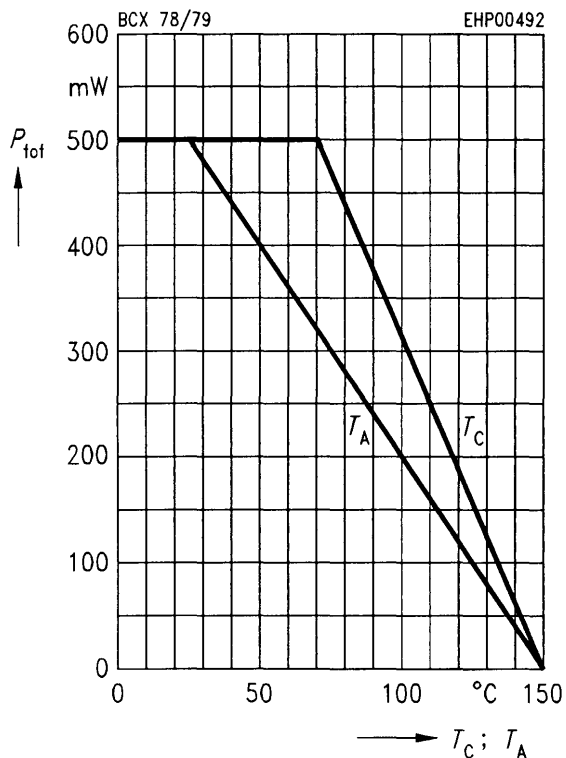

Collector current $I_C = f(V_{BE})$
 $V_{CE} = 5\text{ V}$

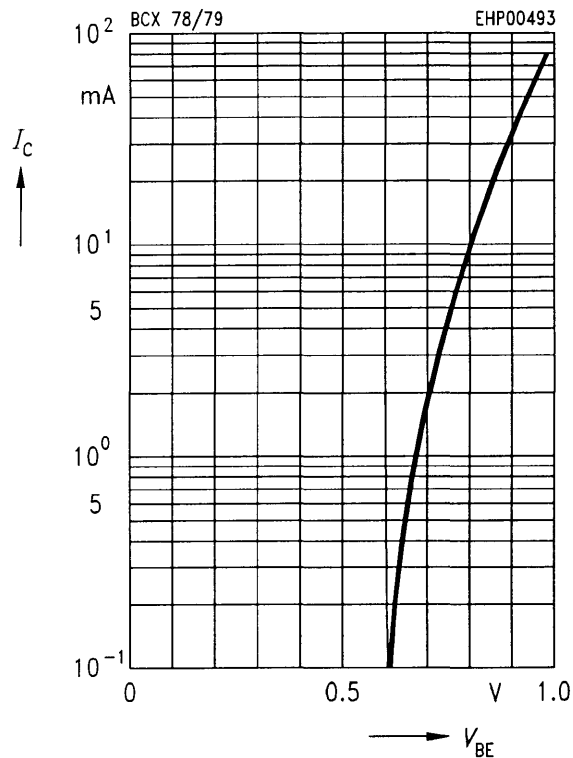

Permissible pulse load $R_{thJA} = f(t_p)$

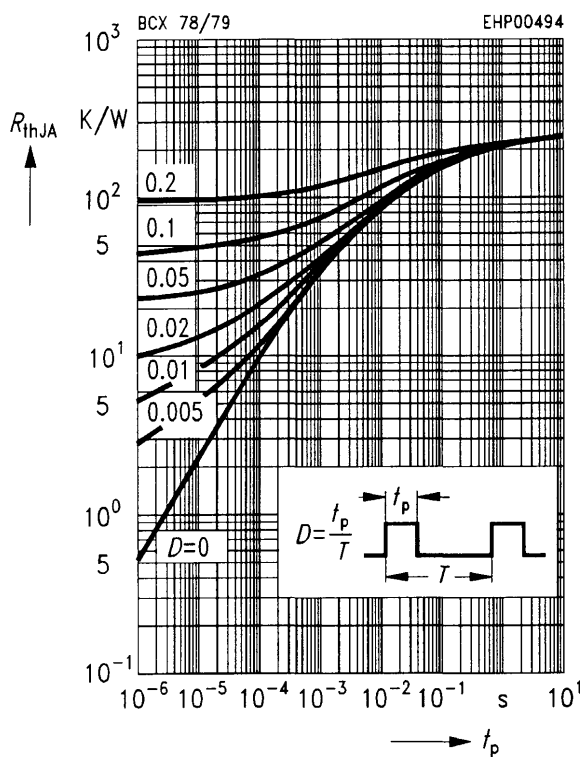

Collector cutoff current $I_{CB0} = f(T_A)$
for max. permissible reverse voltage

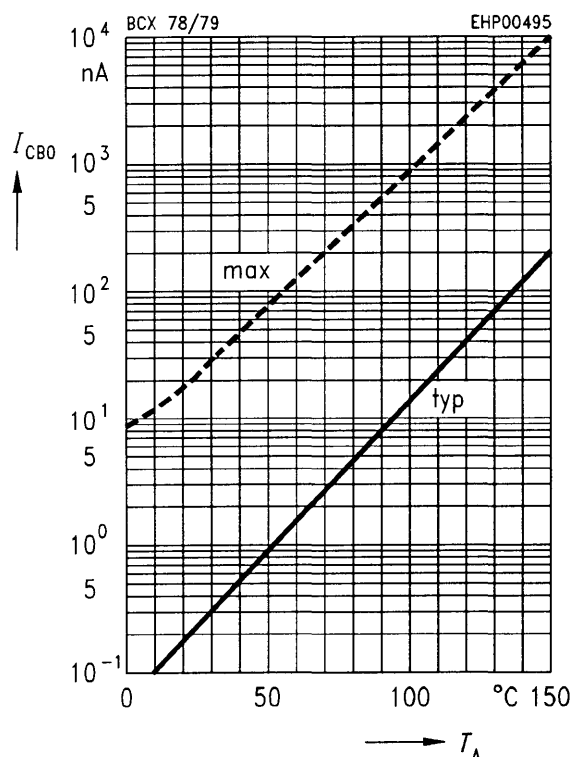

DC current gain $h_{FE} = f(I_C)$
 $V_{CE} = 5\text{ V}$ (common emitter configuration)

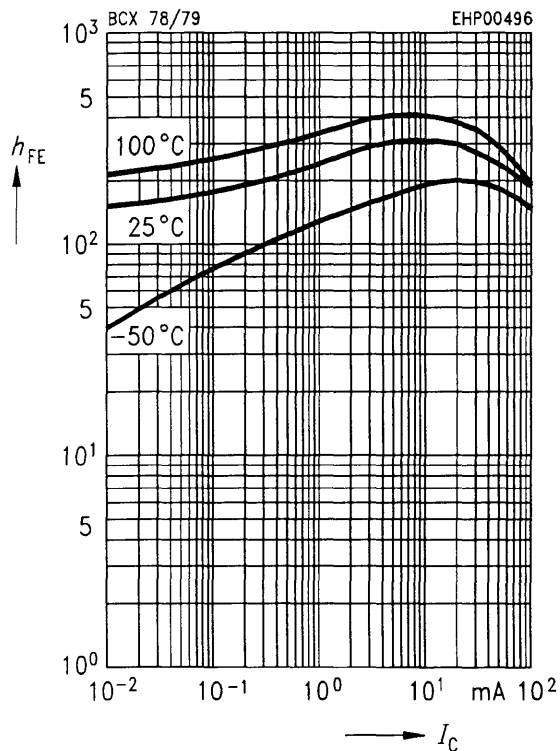

Transition frequency $f_T = f(I_C)$
 $V_{CE} = 5\text{ V}$

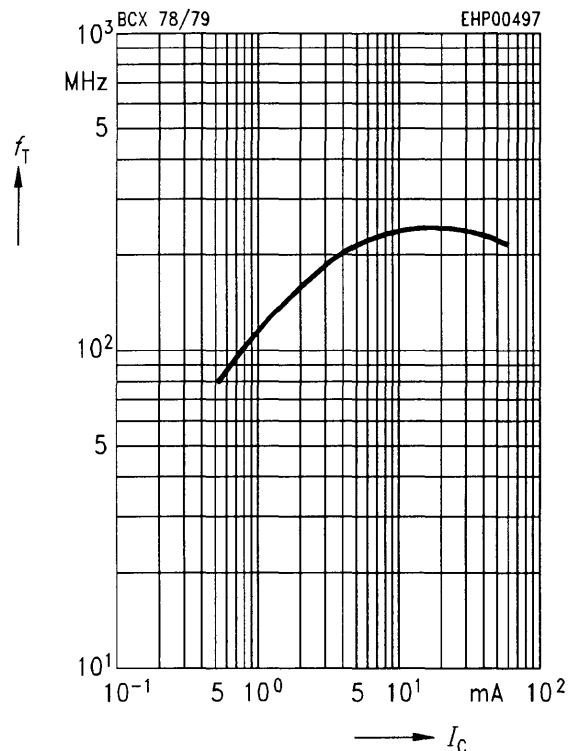

Collector-emitter saturation voltage

$I_C = f(V_{CEsat})$
 $h_{FE} = 20$

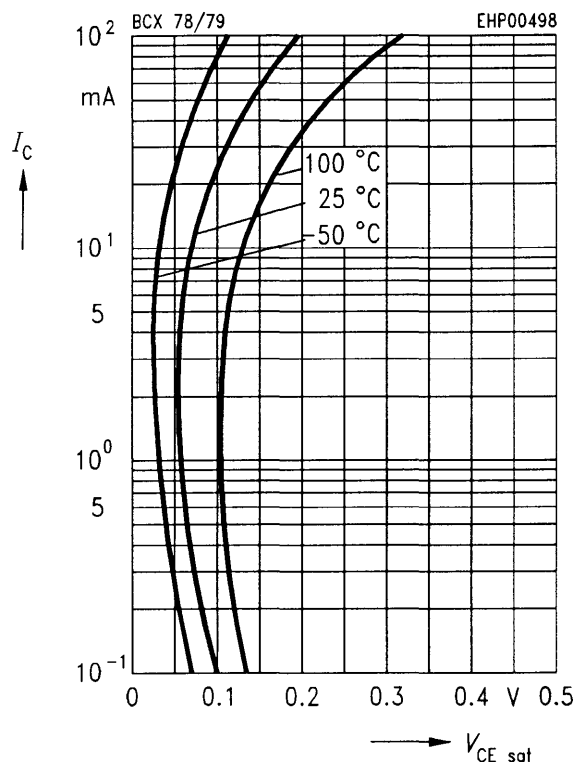

Base-emitter saturation voltage

$I_C = f(V_{BEsat})$
 $h_{FE} = 20$

