

**Silicon N-Channel MOSFET Tetrode**

- For low noise, high gain controlled input stages up to 1 GHz
- Operating voltage 5V
- Integrated biasing network
- Pb-free (RoHS compliant) package<sup>1)</sup>
- Qualified according AEC Q101

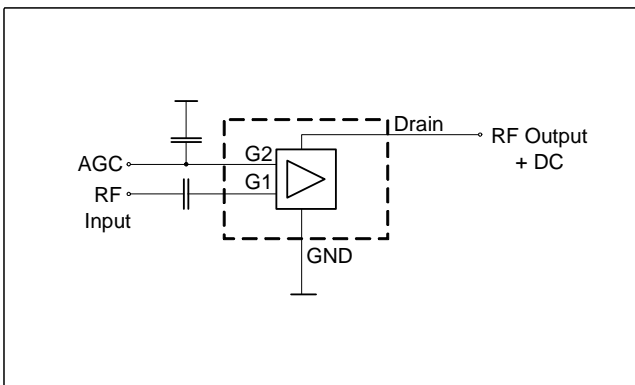
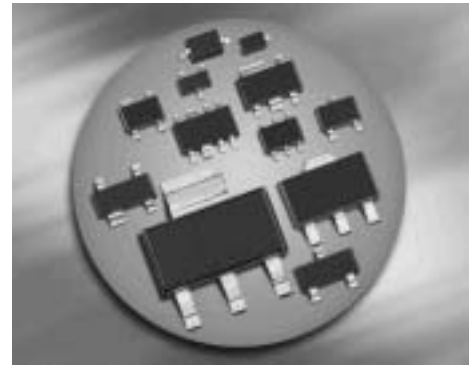

**ESD (Electrostatic discharge) sensitive device, observe handling precaution!**

Type	Package	Pin Configuration						Marking
BF1005	SOT143	1=S	2=D	3=G2	4=G1	-	-	MZs
BF1005R	SOT143R	1=D	2=S	3=G1	4=G2	-	-	MZs

**Maximum Ratings**

Parameter	Symbol	Value	Unit
Drain-source voltage	$V_{DS}$	8	V
Continuous drain current	$I_D$	25	mA
Gate 1/ gate 2-source current	$\pm I_{G1/2SM}$	10	
Gate 1 (external biasing)	$+V_{G1SE}$	3	V
Total power dissipation $T_S \leq 76 \text{ }^\circ\text{C}$	$P_{tot}$	200	mW
Storage temperature	$T_{stg}$	-55 ... 150	$^\circ\text{C}$
Channel temperature	$T_{ch}$	150	

<sup>1</sup>Pb-containing package may be available upon special request

**Note:**

**It is not recommended to apply external DC-voltage on Gate 1 in active mode.**

**Thermal Resistance**

Parameter	Symbol	Value	Unit
Channel - soldering point <sup>1)</sup>	$R_{thchs}$	$\leq 370$	K/W

**Electrical Characteristics** at  $T_A = 25^\circ\text{C}$ , unless otherwise specified

Parameter	Symbol	Values			Unit
		min.	typ.	max.	

**DC Characteristics**

Drain-source breakdown voltage $I_D = 650 \mu\text{A}$ , $V_{G1S} = 0$ , $V_{G2S} = 0$	$V_{(BR)DS}$	12	-	-	V
Gate1-source breakdown voltage $+I_{G1S} = 10 \text{ mA}$ , $V_{G2S} = 0$ , $V_{DS} = 0$	$+V_{(BR)G1SS}$	8	-	12	
Gate2 source breakdown voltage $\pm I_{G2S} = 10 \text{ mA}$ , $V_{G1S} = 0$ , $V_{DS} = 0$	$\pm V_{(BR)G2SS}$	8	-	13	
Gate1-source leakage current $V_{G1S} = 0$ , $V_{G2S} = 6 \text{ V}$	$+I_{G1SS}$	-	100	-	$\mu\text{A}$
Gate 2 source leakage current $\pm V_{G2S} = 8 \text{ V}$ , $V_{G1S} = 0$ , $V_{DS} = 0$	$\pm I_{G2SS}$	-	-	50	nA
Drain current $V_{DS} = 5 \text{ V}$ , $V_{G1S} = 0$ , $V_{G2S} = 4 \text{ V}$	$I_{DSS}$	-	-	1.5	mA
Operating current (selfbiased) $V_{DS} = 5 \text{ V}$ , $V_{G2S} = 4 \text{ V}$	$I_{DSO}$	8	10	16	
Gate2-source pinch-off voltage $V_{DS} = 5 \text{ V}$ , $I_D = 100 \mu\text{A}$	$V_{G2S(p)}$	-	1	-	V

<sup>1)</sup>For calculation of  $R_{thJA}$  please refer to Application Note Thermal Resistance

**Electrical Characteristics** at  $T_A = 25^\circ\text{C}$ , unless otherwise specified

Parameter	Symbol	Values			Unit
		min.	typ.	max.	
<b>AC Characteristics</b> (verified by random sampling)					
Forward transconductance $V_{DS} = 5\text{ V}$ , $V_{G2S} = 4.5\text{ V}$	$g_{fs}$	20	24	-	mS
Gate1 input capacitance $V_{DS} = 5\text{ V}$ , $V_{G2S} = 4\text{ V}$ , $f = 10\text{ MHz}$	$C_{g1ss}$	-	2.1	2.5	pF
Output capacitance $V_{DS} = 5\text{ V}$ , $V_{G2S} = 4\text{ V}$ , $f = 10\text{ MHz}$	$C_{dss}$	-	1.3	-	
Power gain (self biased) $V_{DS} = 5\text{ V}$ , $V_{G2S} = 4\text{ V}$ , $f = 800\text{ MHz}$	$G_p$	17	19	-	dB
Noise figure $V_{DS} = 5\text{ V}$ , $V_{G2S} = 4\text{ V}$ , $f = 800\text{ MHz}$	$F$	-	1.6	2.5	dB
Gain control range $V_{DS} = 5\text{ V}$ , $V_{G2S} = 4\text{ V} \dots 0\text{ V}$ , $f = 800\text{ GHz}$	$\Delta G_p$	40	50	-	

**Total power dissipation  $P_{tot} = f(T_S)$** 

BF1005, BF1005R

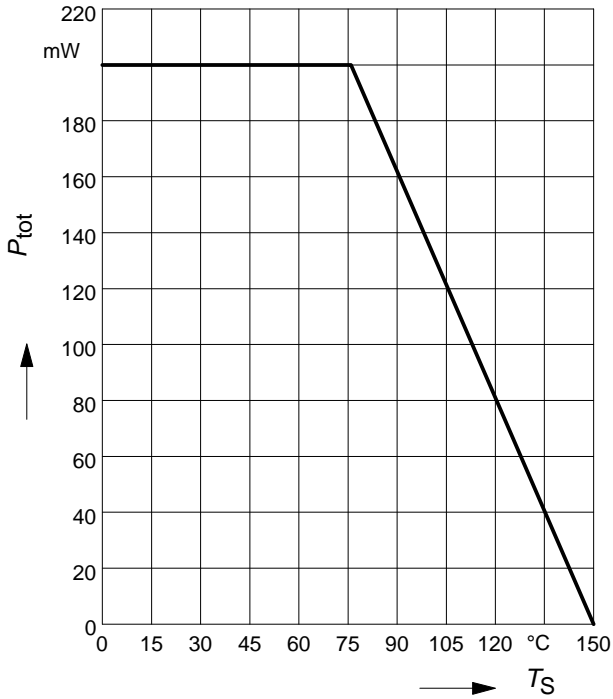
**Total power dissipation  $P_{tot} = f(T_S)$** 

BF1005W

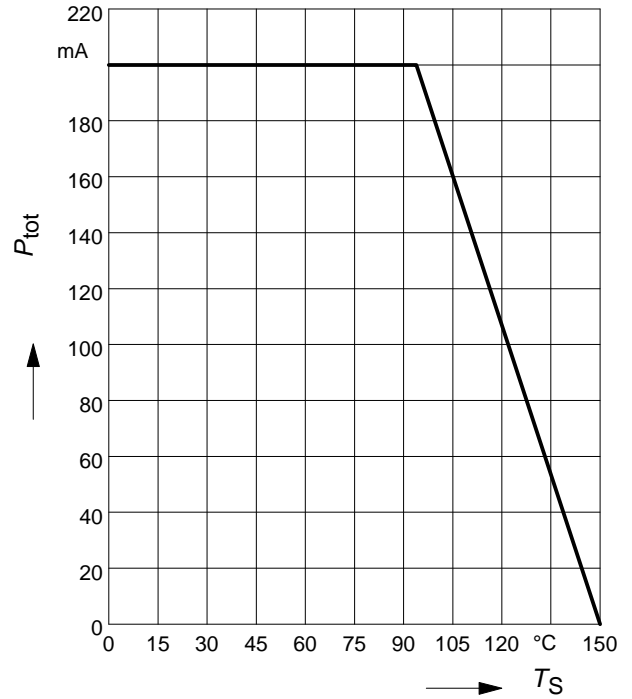
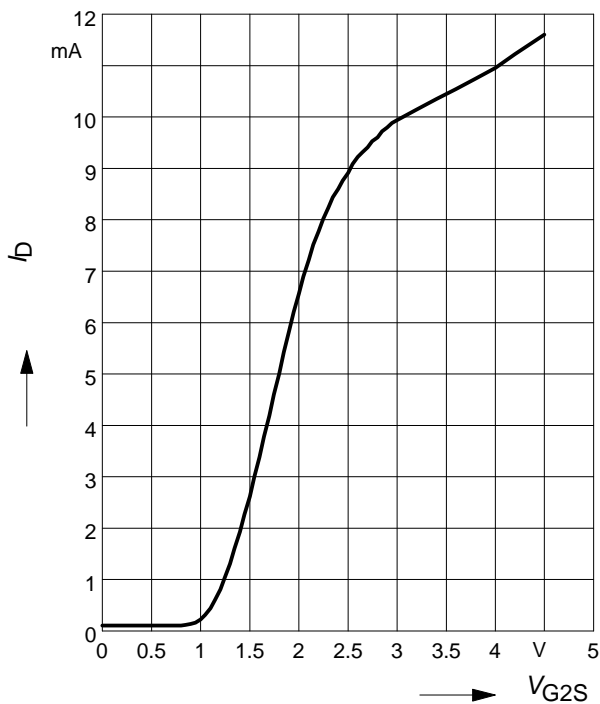

**Drain current  $I_D = f(V_{G2S})$** 

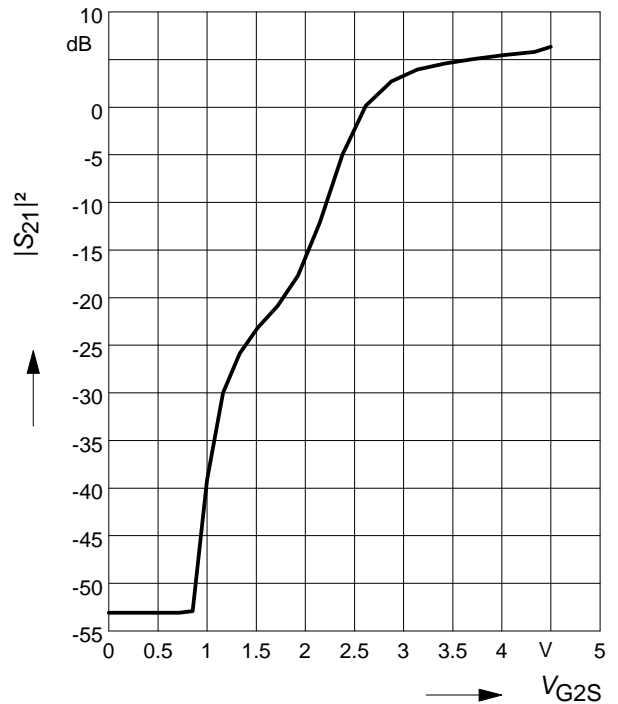
**Insertion power gain**

$$|S_{21}|^2 = f(V_{G2S})$$

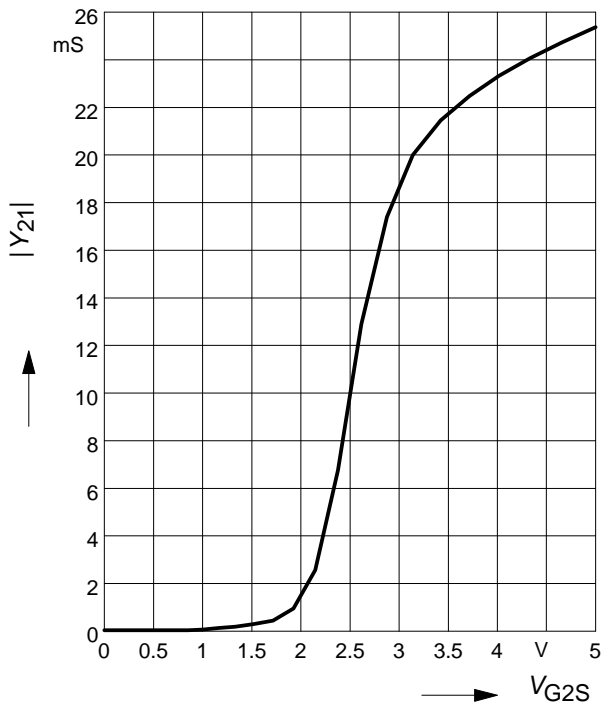

**Forward transfer admittance**

$$|Y_{21}| = f(V_{G2S})$$



**Gate 1 input capacitance  $C_{g1ss} = f(V_{G2S})$**

$f = 200\text{MHz}$

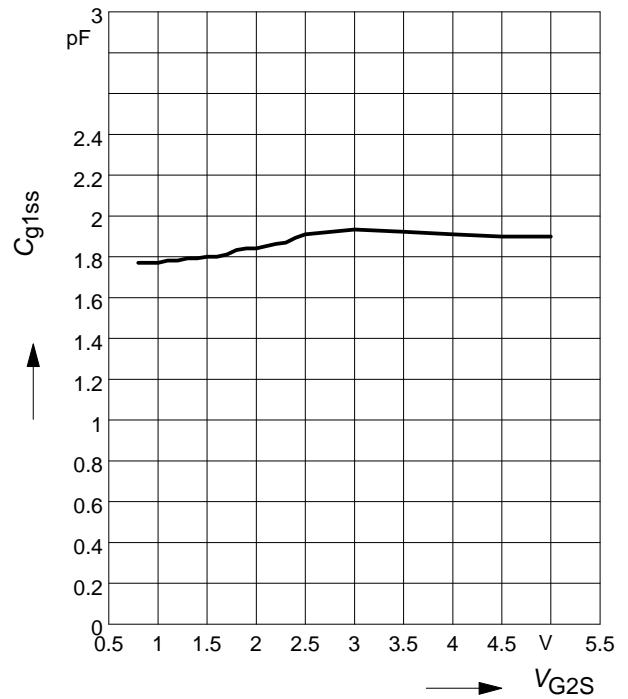

**Output capacitance  $C_{dss} = f(V_{G2S})$**

$f = 200\text{MHz}$

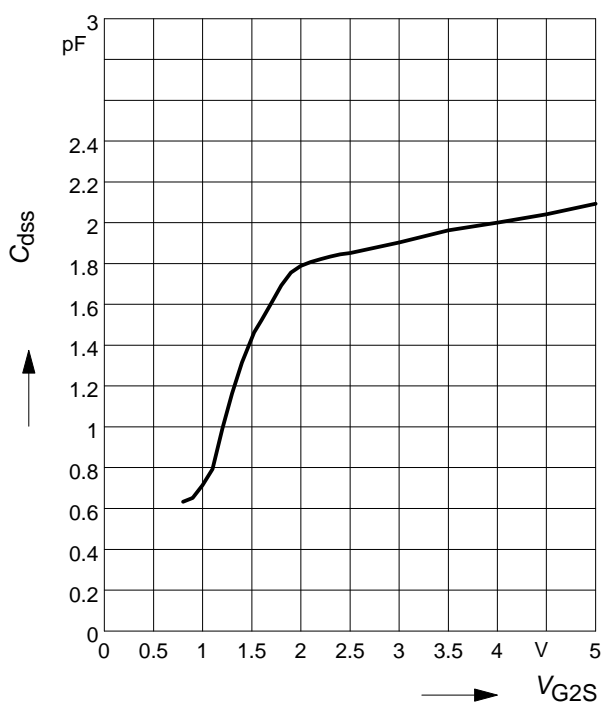

Package Outline

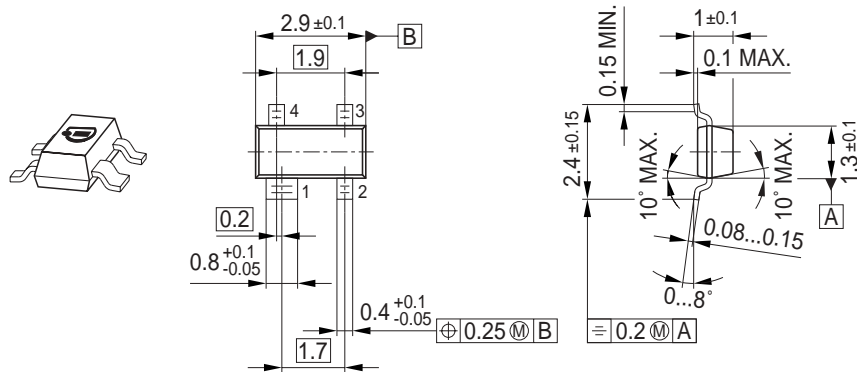

Foot Print

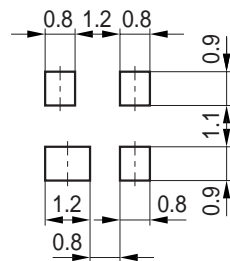

Marking Layout (Example)

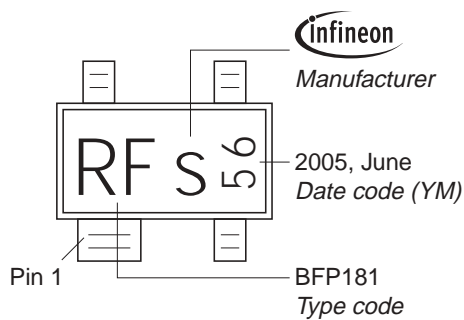

Standard Packing

Reel  $\varnothing 180 \text{ mm}$  = 3.000 Pieces/Reel  
 Reel  $\varnothing 330 \text{ mm}$  = 10.000 Pieces/Reel



Package Outline

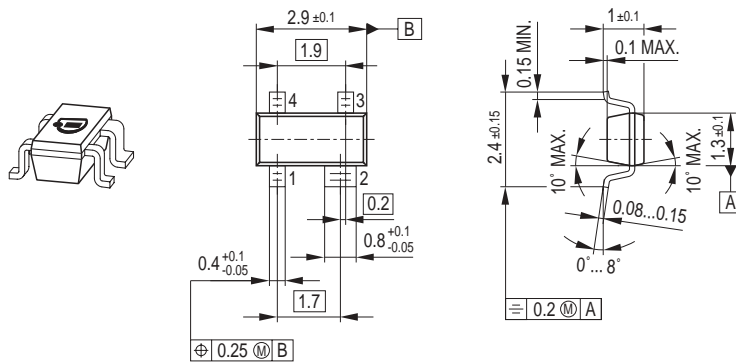

Foot Print

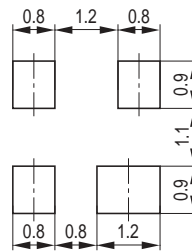

Marking Layout (Example)

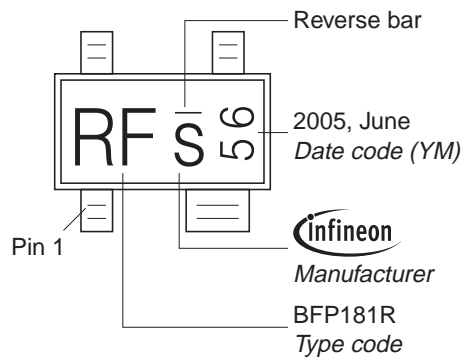

Standard Packing

Reel  $\varnothing$ 180 mm = 3.000 Pieces/Reel  
 Reel  $\varnothing$ 330 mm = 10.000 Pieces/Reel

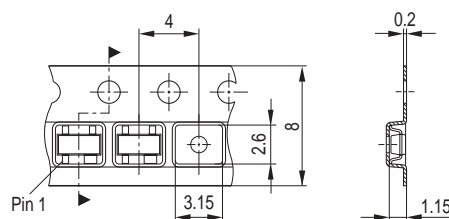

Edition 2006-02-01  
Published by  
Infineon Technologies AG  
81726 München, Germany  
© Infineon Technologies AG 2007.  
All Rights Reserved.

### **Attention please!**

The information given in this dokument shall in no event be regarded as a guarantee of conditions or characteristics ("Beschaffenheitsgarantie"). With respect to any examples or hints given herein, any typical values stated herein and/or any information regarding the application of the device, Infineon Technologies hereby disclaims any and all warranties and liabilities of any kind, including without limitation warranties of non-infringement of intellectual property rights of any third party.

### **Information**

For further information on technology, delivery terms and conditions and prices please contact your nearest Infineon Technologies Office ([www.infineon.com](http://www.infineon.com)).

### **Warnings**

Due to technical requirements components may contain dangerous substances. For information on the types in question please contact your nearest Infineon Technologies Office.

Infineon Technologies Components may only be used in life-support devices or systems with the express written approval of Infineon Technologies, if a failure of such components can reasonably be expected to cause the failure of that life-support device or system, or to affect the safety or effectiveness of that device or system.

Life support devices or systems are intended to be implanted in the human body, or to support and/or maintain and sustain and/or protect human life. If they fail, it is reasonable to assume that the health of the user or other persons may be endangered.