

Silicon N Channel MOSFET Triode

BF 999

- For high-frequency stages up to 300 MHz, preferably in FM applications

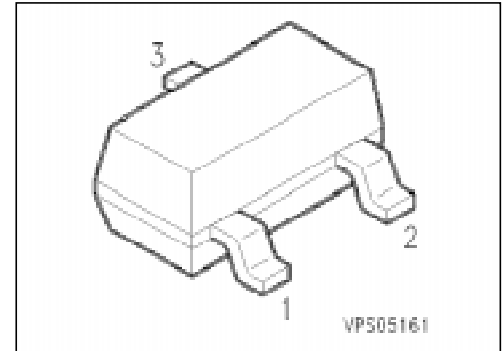

Type	Marking	Ordering Code (tape and reel)	Pin Configuration			Package ¹⁾
			1	2	3	
BF 999	LB	Q62702-F1132	G	D	S	SOT-23

Maximum Ratings

Parameter	Symbol	Values	Unit
Drain-source voltage	V_{DS}	20	V
Drain current	I_D	30	mA
Gate-source peak current	$\pm I_{GSM}$	10	
Total power dissipation, $T_A \leq 60 \text{ }^\circ\text{C}$	P_{tot}	200	mW
Storage temperature range	T_{stg}	- 55 ... + 150	$^\circ\text{C}$
Channel temperature	T_{ch}	150	

Thermal Resistance

Junction - ambient ²⁾	$R_{th JA}$	≤ 450	K/W
----------------------------------	-------------	------------	-----

¹⁾ For detailed information see chapter Package Outlines.

²⁾ Package mounted on alumina 15 mm × 16.7 mm × 0.7 mm.

Electrical Characteristics

at $T_A = 25\text{ }^\circ\text{C}$, unless otherwise specified.

Parameter	Symbol	Values			Unit
		min.	typ.	max.	

DC Characteristics

Drain-source breakdown voltage $I_D = 10\text{ }\mu\text{A}$, $-V_{GS} = 4\text{ V}$	$V_{(BR)DS}$	20	–	–	V
Gate-source breakdown voltage $\pm I_{GS} = 10\text{ mA}$, $V_{DS} = 0$	$\pm V_{(BR)GSS}$	6.5	–	12	
Gate-source leakage current $\pm V_{GS} = 5\text{ V}$, $V_{DS} = 0$	$\pm I_{GSS}$	–	–	50	nA
Drain current $V_{DS} = 10\text{ V}$, $V_{GS} = 0$	I_{DSS}	5	–	18	mA
Gate-source pinch-off voltage $V_{DS} = 10\text{ V}$, $I_D = 20\text{ }\mu\text{A}$	$-V_{GS(p)}$	–	–	2.5	V

AC Characteristics

Forward transconductance $V_{DS} = 10\text{ V}$, $I_D = 10\text{ mA}$, $f = 1\text{ kHz}$	g_{fs}	14	16	–	mS
Gate input capacitance $V_{DS} = 10\text{ V}$, $I_D = 10\text{ mA}$, $f = 1\text{ MHz}$	C_{gss}	–	2.5	–	pF
Reverse transfer capacitance $V_{DS} = 10\text{ V}$, $I_D = 10\text{ mA}$, $f = 1\text{ MHz}$	C_{dg}	–	25	–	fF
Output capacitance $V_{DS} = 10\text{ V}$, $I_D = 10\text{ mA}$, $f = 1\text{ MHz}$	C_{dss}	–	1	–	pF
Power gain (test circuit) $V_{DS} = 10\text{ V}$, $I_D = 10\text{ mA}$, $f = 200\text{ MHz}$, $G_G = 2\text{ mS}$, $G_L = 0.5\text{ mS}$	G_p	–	25	–	dB
Noise figure (test circuit) $V_{DS} = 10\text{ V}$, $I_D = 10\text{ mA}$, $f = 200\text{ MHz}$, $G_G = 2\text{ mS}$, $G_L = 0.5\text{ mS}$	F	–	1	–	

Total power dissipation $P_{tot} = f(T_A)$

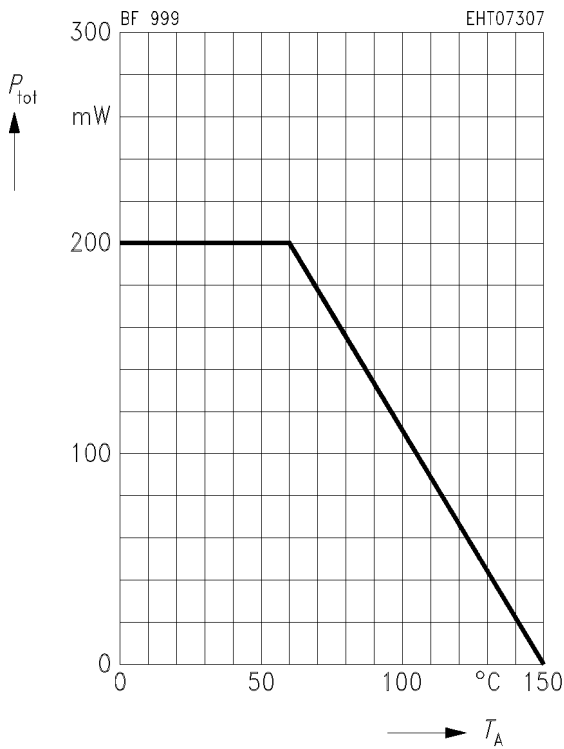

Output characteristics $I_D = f(V_{DS})$

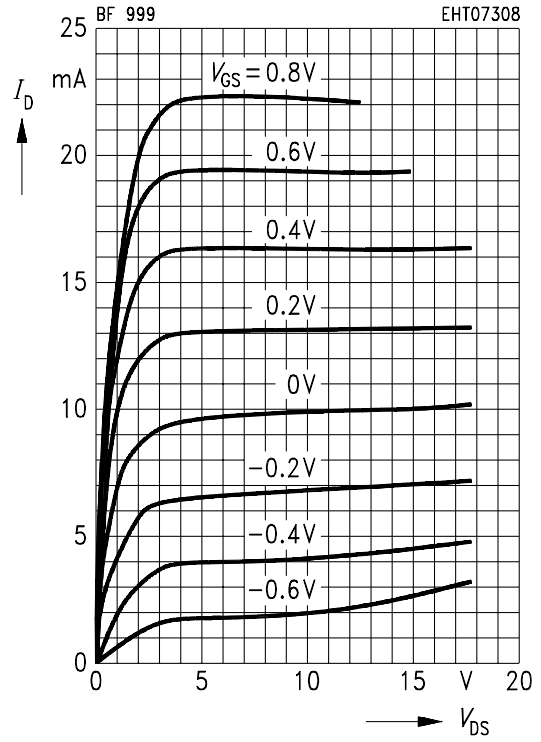

Gate transconductance $g_{fs} = f(V_{GS})$
 $V_{DS} = 10$ V, $I_{DSS} = 10$ mA, $f = 1$ kHz

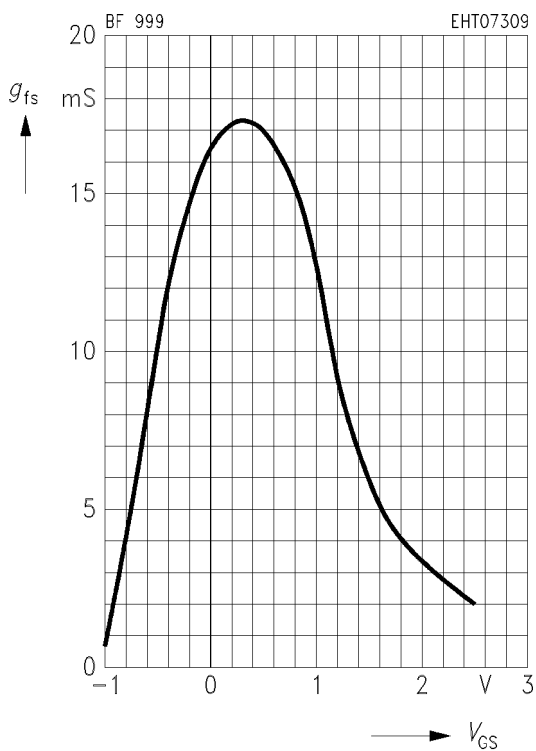

Drain current $I_D = f(V_{GS})$
 $V_{DS} = 10$ V

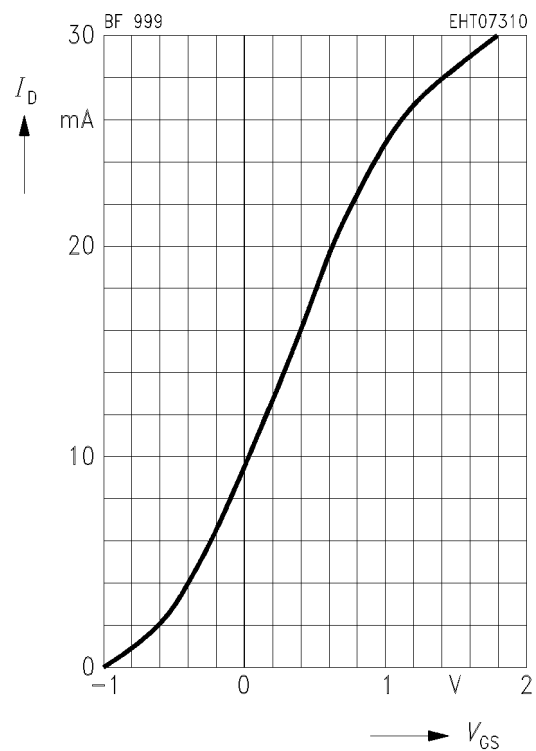

Gate input capacitance $C_{gss} = f(V_{GS})$

$V_{DS} = 10\text{ V}, I_{DSS} = 10\text{ mA}, f = 1\text{ MHz}$

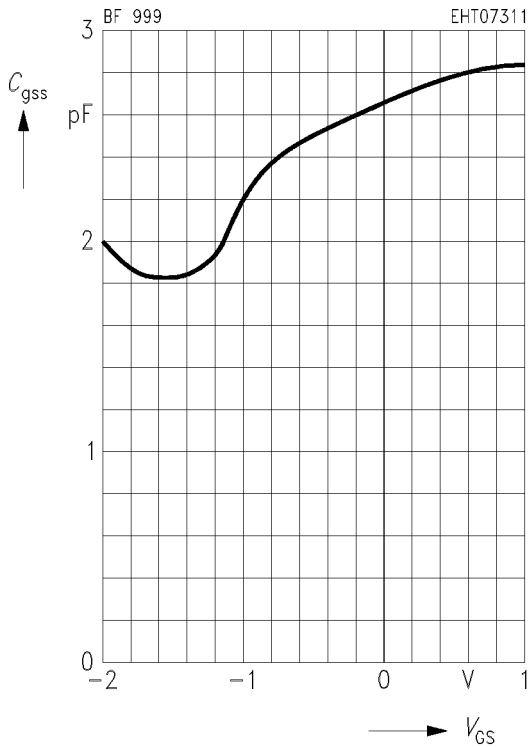

Output capacitance $C_{dss} = f(V_{DS})$

$V_{GS} = 0, I_{DSS} = 10\text{ mA}, f = 1\text{ MHz}$

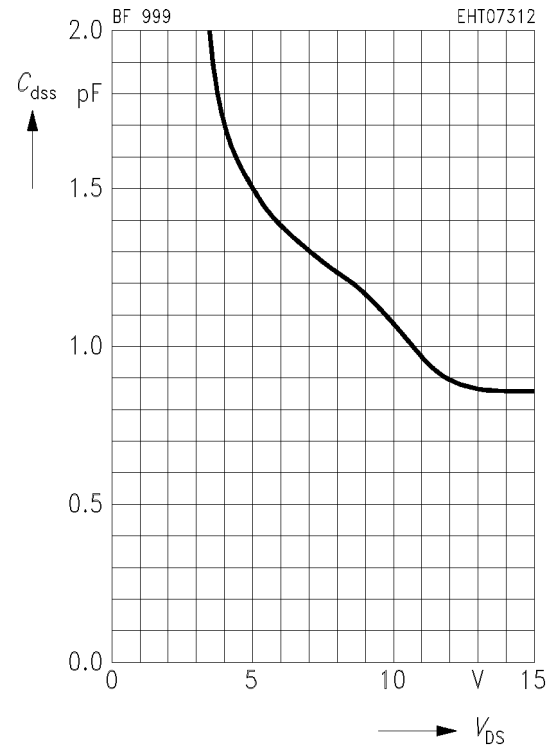

Reverse transfer capacitance

$C_{dg} = f(V_{DS})$

$I_{DSS} = 10\text{ mA}, f = 1\text{ MHz}, V_{GS} = 0$

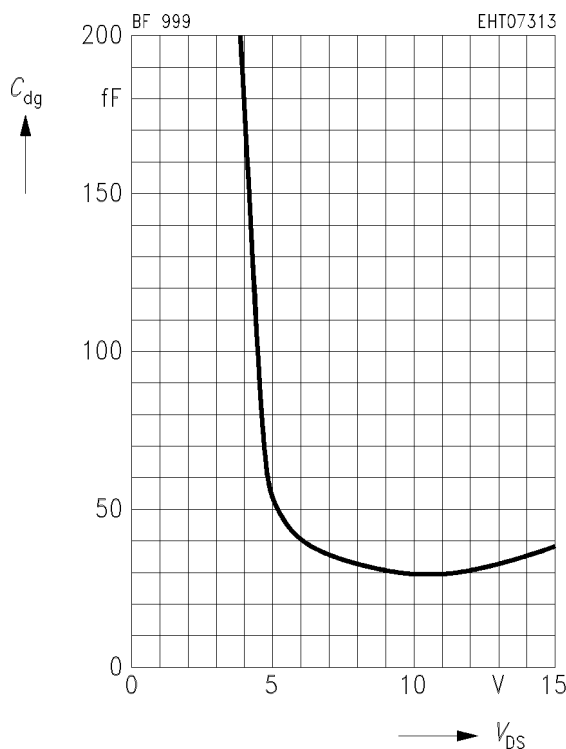

Gate input admittance y_{11s}

$V_{DS} = 10\text{ V}, V_{GS} = 0,$

$I_{DSS} = 10\text{ mA},$ (common-source)

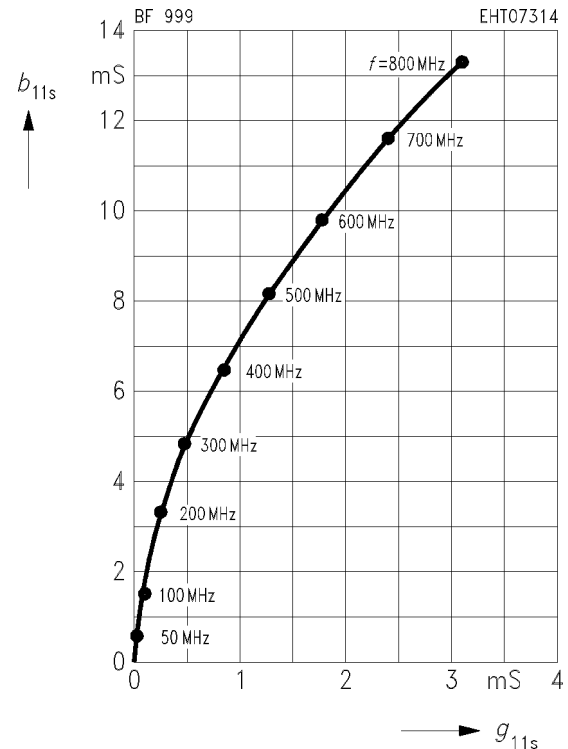

Gate forward transfer admittance y_{21s}

$V_{DS} = 10\text{ V}$, $V_{GS} = 0$,
 $I_{DSS} = 10\text{ mA}$, (common-source)

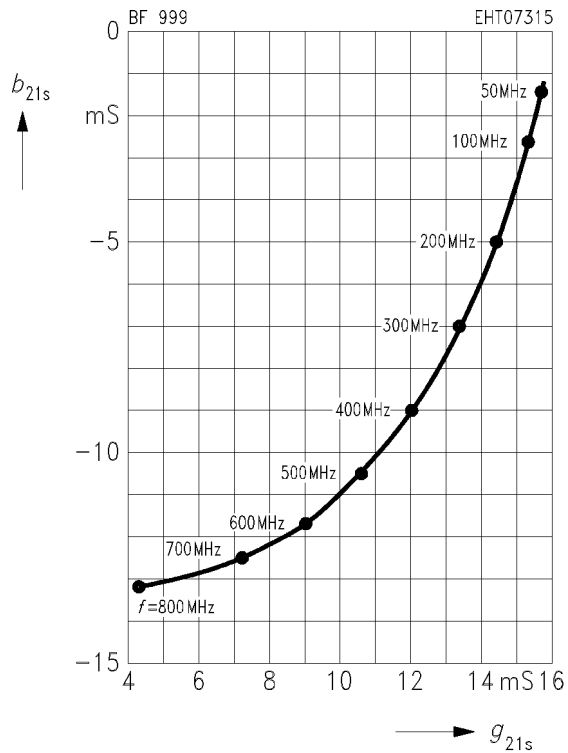

Output admittance y_{22s}

$V_{DS} = 10\text{ V}$, $V_{GS} = 0$,
 $I_{DSS} = 10\text{ mA}$, (common-source)

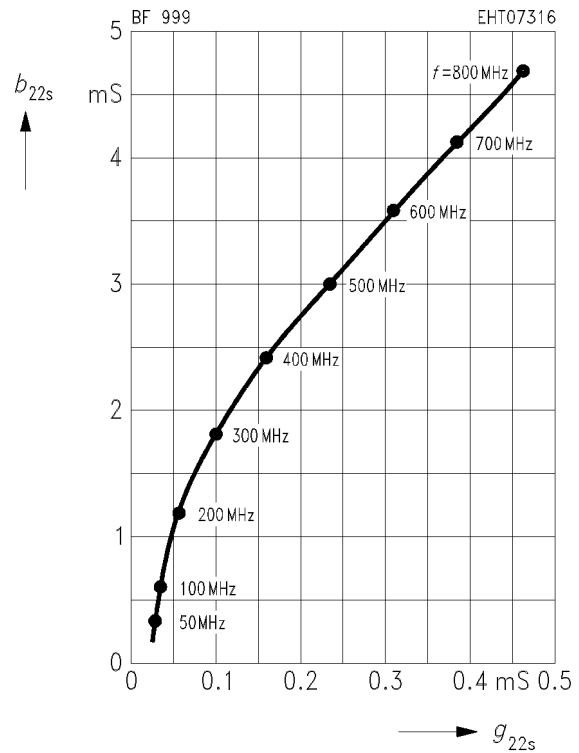

Test circuit for power gain and noise figure

$f = 200\text{ MHz}$

