

NPN Silicon High-Voltage Transistors

- Suitable for video output stages in TV sets and switching power supplies
- High breakdown voltage
- Low collector-emitter saturation voltage
- Complementary types: BFN17, BFN19 (PNP)

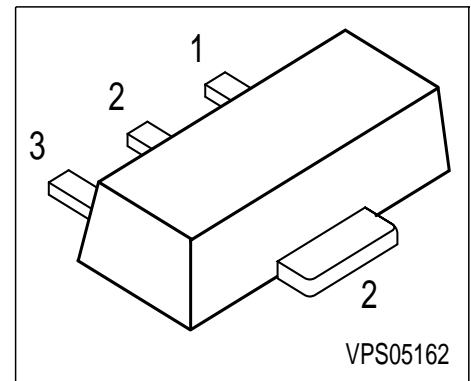

Type	Marking	Pin Configuration			Package
BFN16	DD	1 = B	2 = C	3 = E	SOT89
BFN18	DE	1 = B	2 = C	3 = E	SOT89

Maximum Ratings

Parameter	Symbol	BFN16	BFN18	Unit
Collector-emitter voltage	V_{CEO}	250	300	V
Collector-base voltage	V_{CBO}	250	300	
Emitter-base voltage	V_{EBO}	5	5	
DC collector current	I_C	200		mA
Peak collector current	I_{CM}	500		
Base current	I_B	100		
Peak base current	I_{BM}	200		
Total power dissipation, $T_S = 130\text{ °C}$	P_{tot}	1		W
Junction temperature	T_j	150		°C
Storage temperature	T_{stg}	-65 ... 150		

Thermal Resistance

Junction - soldering point ⁽¹⁾	R_{thJS}	≤20	K/W
---	------------	-----	-----

¹For calculation of R_{thJA} please refer to Application Note Thermal Resistance

Electrical Characteristics at $T_A = 25^\circ\text{C}$, unless otherwise specified.

Parameter	Symbol	Values			Unit
		min.	typ.	max.	
DC Characteristics					
Collector-emitter breakdown voltage $I_C = 1 \text{ mA}, I_B = 0$	$V_{(BR)CEO}$				V
BFN16		250	-	-	
BFN18		300	-	-	
Collector-base breakdown voltage $I_C = 100 \mu\text{A}, I_E = 0$	$V_{(BR)CBO}$				
BFN16		250	-	-	
BFN18		300	-	-	
Emitter-base breakdown voltage $I_E = 100 \mu\text{A}, I_C = 0$	$V_{(BR)EBO}$	5	-	-	
Collector cutoff current $V_{CB} = 200 \text{ V}, I_E = 0$	I_{CBO}				nA
BFN16		-	-	100	
$V_{CB} = 250 \text{ V}, I_E = 0$	BFN18			100	
Collector cutoff current $V_{CB} = 200 \text{ V}, I_E = 0, T_A = 150^\circ\text{C}$	I_{CBO}				μA
BFN16		-	-	20	
$V_{CB} = 250 \text{ V}, I_E = 0, T_A = 150^\circ\text{C}$	BFN18			20	
Emitter cutoff current $V_{EB} = 3 \text{ V}, I_C = 0$	I_{EBO}	-	-	100	nA
DC current gain 1) $I_C = 1 \text{ mA}, V_{CE} = 10 \text{ V}$	h_{FE}	25	-	-	-
$I_C = 10 \text{ mA}, V_{CE} = 10 \text{ V}$		40	-	-	
$I_C = 30 \text{ mA}, V_{CE} = 10 \text{ V}$	BFN16	40	-	-	
	BFN18	30	-	-	
Collector-emitter saturation voltage1) $I_C = 20 \text{ mA}, I_B = 2 \text{ mA}$	V_{CEsat}				V
BFN16		-	-	0.4	
BFN18		-	-	0.5	
Base-emitter saturation voltage 1) $I_C = 20 \text{ mA}, I_B = 2 \text{ mA}$	V_{BEsat}	-	-	0.9	

 1) Pulse test: $t < 300\mu\text{s}$; $D < 2\%$

Electrical Characteristics at $T_A = 25^\circ\text{C}$, unless otherwise specified.

Parameter	Symbol	Values			Unit
		min.	typ.	max.	
AC Characteristics					
Transition frequency $I_C = 20\text{ mA}$, $V_{CE} = 10\text{ V}$, $f = 20\text{ MHz}$	f_T	-	70	-	MHz
Collector-base capacitance $V_{CB} = 30\text{ V}$, $f = 1\text{ MHz}$	C_{cb}	-	2.5	-	pF

Total power dissipation $P_{tot} = f(T_S)$

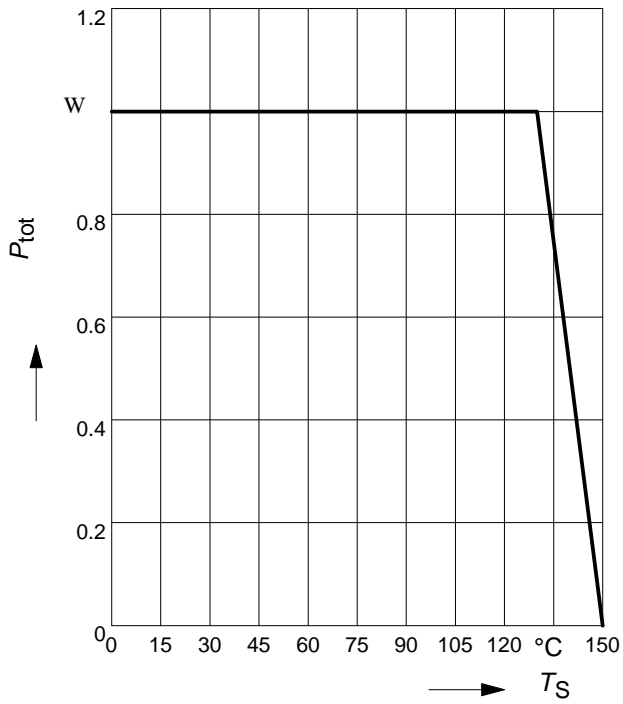

Operating range $I_C = f(V_{CE0})$

$T_A = 25^\circ\text{C}, D = 0$

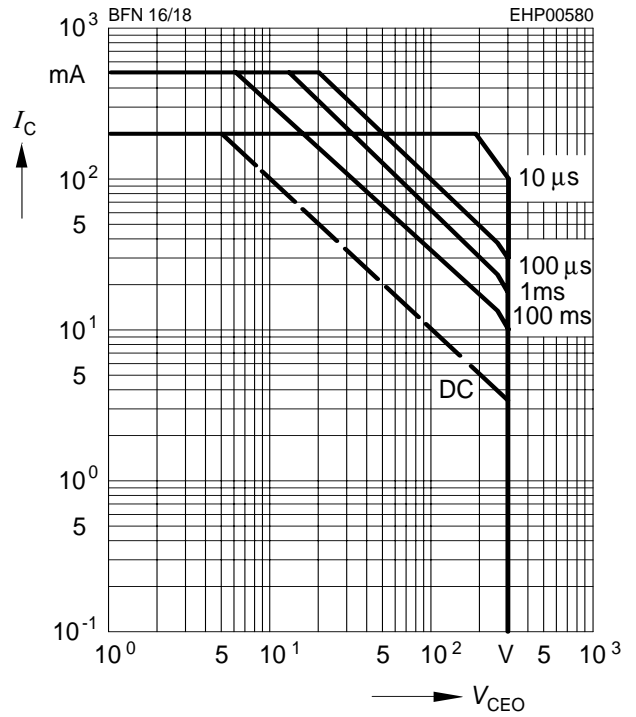

Permissible pulse load

$P_{totmax} / P_{totDC} = f(t_p)$

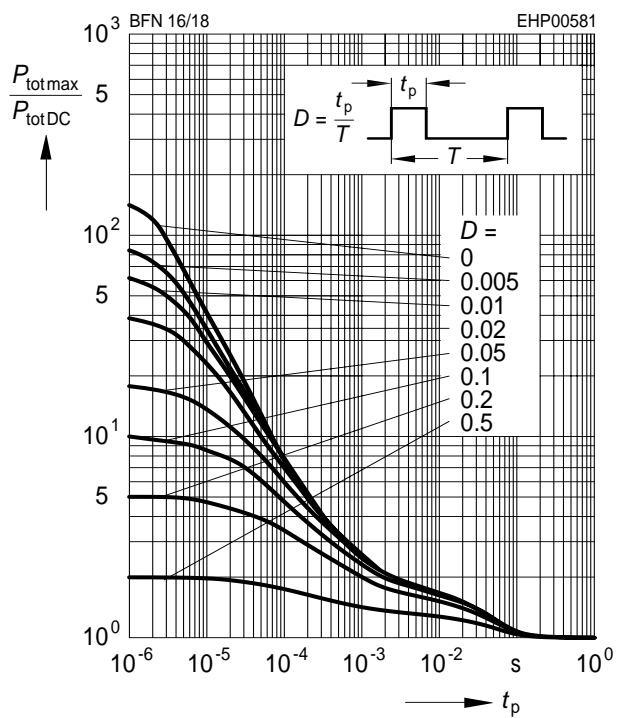

Collector current $I_C = f(V_{BE})$

$V_{CE} = 10\text{V}$

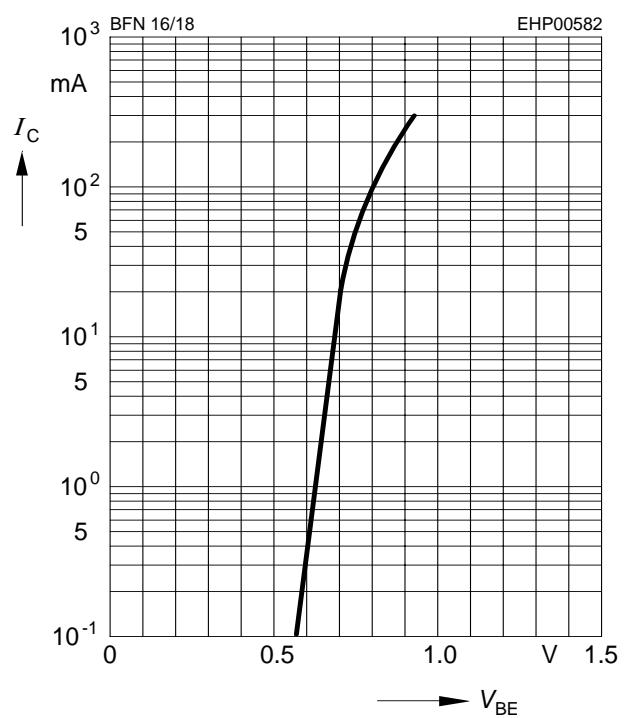

Transition frequency $f_T = f(I_C)$

$V_{CE} = 10V$

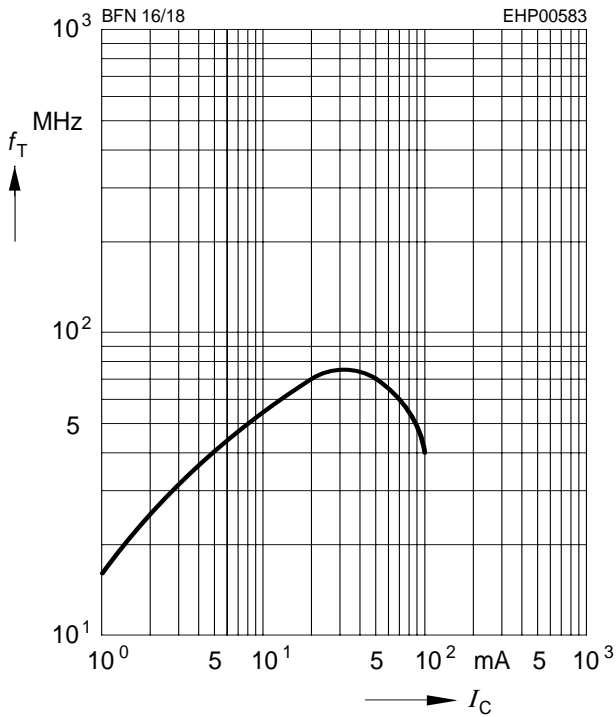

Collector cutoff current $I_{CBO} = f(T_A)$

$V_{CB} = 200V$

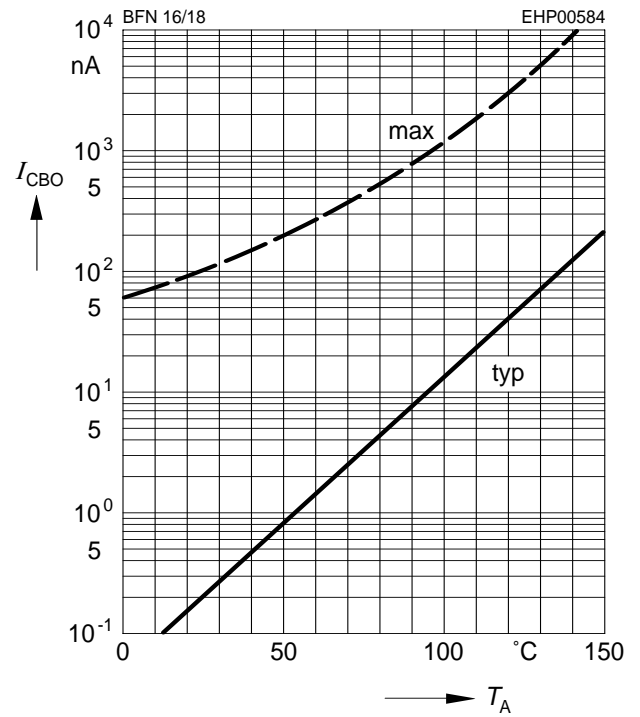

DC current gain $h_{FE} = f(I_C)$

$V_{CE} = 10V$

