

NPN Silicon RF Transistor

BFQ 70

- For low-noise IF and broadband amplifiers in antenna and telecommunications systems at collector currents from 2 mA to 20 mA.
- Hermetically sealed ceramic package
- HiRel/Mil screening available.

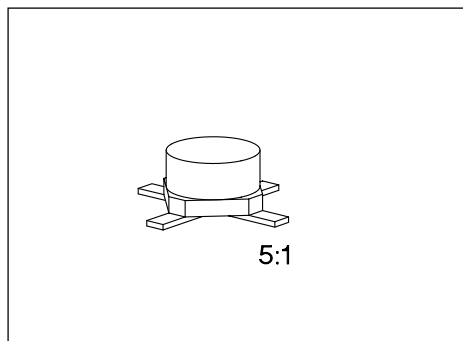

ESD: Electrostatic discharge sensitive device, observe handling precautions!

Type	Marking	Ordering Code (tape and reel)	Pin Configuration				Package ¹⁾
			1	2	3	4	
BFQ 70	70	Q62702-F774	B	E	C	E	Cerex-X

Maximum Ratings

Parameter	Symbol	Values	Unit
Collector-emitter voltage	V_{CE0}	15	V
Collector-emitter voltage, $V_{BE} = 0$	V_{CES}	20	
Collector-base voltage	V_{CB0}	20	
Emitter-base voltage	V_{EB0}	2.5	
Collector current	I_C	35	mA
Base current	I_B	4	
Total power dissipation, $T_s \leq 121\text{ °C}^3)$	P_{tot}	300	mW
Junction temperature	T_j	175	°C
Ambient temperature range	T_A	- 65 ... + 175	
Storage temperature range	T_{stg}	- 65 ... + 175	

Thermal Resistance

Junction - ambient ²⁾	$R_{th\ JA}$	≤ 260	K/W
Junction - soldering point ³⁾	$R_{th\ JS}$	≤ 180	

1) For detailed dimensions see chapter Package Outlines.

2) Package mounted on alumina 16 mm × 25 mm × 0.7 mm.

3) T_s is measured on the collector lead at the soldering point to the pcb.

Electrical Characteristics

at $T_A = 25\text{ °C}$, unless otherwise specified.

Parameter	Symbol	Values			Unit
		min.	typ.	max.	

DC Characteristics

Collector-emitter breakdown voltage $I_C = 1\text{ mA}, I_B = 0$	$V_{(BR)CE0}$	15	–	–	V
Collector-base cutoff current $V_{CB} = 10\text{ V}, I_E = 0$	I_{CB0}	–	–	50	nA
Emitter-base cutoff current $V_{EB} = 2\text{ V}, I_C = 0$	I_{EB0}	–	–	10	μA
DC current gain $I_C = 3\text{ mA}, V_{CE} = 6\text{ V}$ $I_C = 10\text{ mA}, V_{CE} = 6\text{ V}$	h_{FE}	50 50	– 130	250 –	–
Collector-emitter saturation voltage $I_C = 20\text{ mA}, I_B = 1\text{ mA}$	V_{CEsat}	–	0.1	0.4	V
Base-emitter voltage $I_C = 10\text{ mA}, V_{CE} = 6\text{ V}$	V_{BE}	–	0.78	–	

Electrical Characteristics

at $T_A = 25\text{ °C}$, unless otherwise specified.

Parameter	Symbol	Values			Unit
		min.	typ.	max.	

AC Characteristics

Transition frequency $I_C = 3\text{ mA}$, $V_{CE} = 6\text{ V}$, $f = 200\text{ MHz}$ $I_C = 20\text{ mA}$, $V_{CE} = 6\text{ V}$, $f = 200\text{ MHz}$	f_t	– 3.6	2.7 5	– –	GHz
Collector-base capacitance $V_{CB} = 6\text{ V}$, $V_{BE} = v_{be} = 0$, $f = 1\text{ MHz}$	C_{cb}	–	0.46	0.6	pF
Collector-emitter capacitance $V_{CE} = 6\text{ V}$, $V_{BE} = v_{be} = 0$, $f = 1\text{ MHz}$	C_{ce}	–	0.41	–	
Input capacitance $V_{EB} = 0.5\text{ V}$, $I_C = i_c = 0$, $f = 1\text{ MHz}$	C_{ibo}	–	2.2	–	
Output capacitance $V_{CE} = 6\text{ V}$, $V_{BE} = v_{be} = 0$, $f = 1\text{ MHz}$	C_{obs}	–	0.87	1.3	
Noise figure $I_C = 3\text{ mA}$, $V_{CE} = 6\text{ V}$, $f = 10\text{ MHz}$, $Z_S = 75\text{ }\Omega$ $I_C = 4\text{ mA}$, $V_{CE} = 6\text{ V}$, $f = 800\text{ MHz}$, $Z_S = 50\text{ }\Omega$	F	– –	0.9 1.5	1.2 –	dB
Power gain $I_C = 20\text{ mA}$, $V_{CE} = 6\text{ V}$, $f = 800\text{ MHz}$, $Z_S = Z_{Sopt}$, $Z_L = Z_{Lopt}$	G_{pe}	–	18	–	
Transducer gain $I_C = 10\text{ mA}$, $V_{CE} = 6\text{ V}$, $f = 1\text{ GHz}$, $Z_0 = 50\text{ }\Omega$	$ S_{21e} ^2$	–	13	–	
Linear output voltage two-tone intermodulation test $I_C = 20\text{ mA}$, $V_{CE} = 6\text{ V}$, $d_{IM} = 60\text{ dB}$, $f_1 = 806\text{ MHz}$, $f_2 = 810\text{ MHz}$, $Z_S = Z_L = 50\text{ }\Omega$	$V_{o1} = V_{o2}$	–	170	–	mV
Third order intercept point $I_C = 20\text{ mA}$, $V_{CE} = 6\text{ V}$, $f = 800\text{ MHz}$	IP_3	–	27.5	–	dBm

Total power dissipation $P_{tot} = f(T_A^*; T_S)$

*Package mounted on alumina

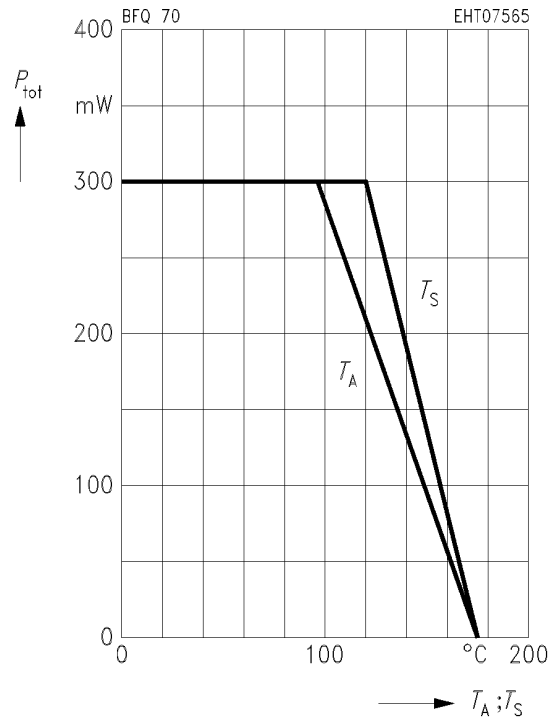

Transition frequency $f_T = f(I_C)$

$V_{CE} = 6\text{ V}, f = 200\text{ MHz}$

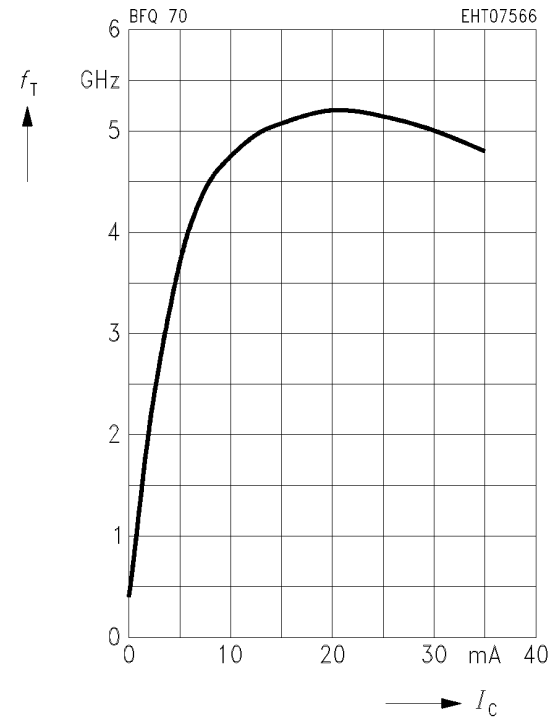

Collector-base capacitance $C_{cb} = f(V_{CB})$

$V_{BE} = v_{be} = 0, f = 1\text{ MHz}$

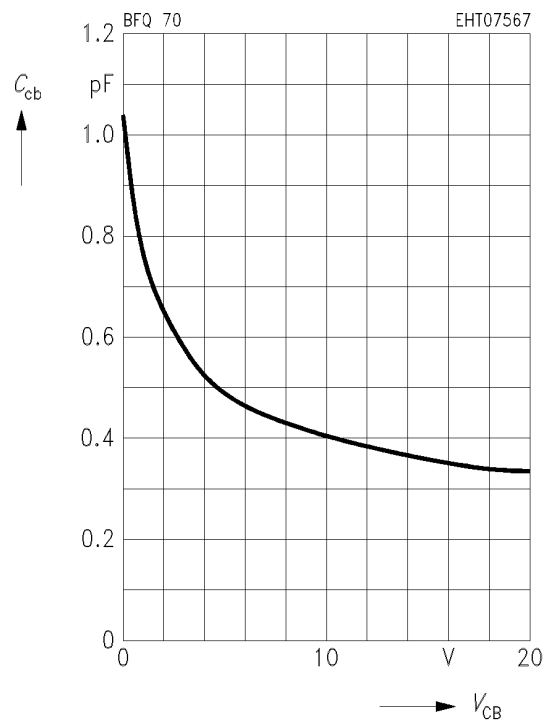

Common Emitter Noise Parameters

f	F_{min}	$G_p(F_{min})$	Γ_{opt}		R_N	N	$F_{50\Omega}$	$G_p(F_{50\Omega})$
GHz	dB	dB	MAG	ANG	Ω	—	dB	dB

$I_C = 3 \text{ mA}, V_{CE} = 6 \text{ V}, Z_0 = 50 \Omega$

0.01	0.8	—	(Z _s = 150 Ω)		—	—	1.2	—
------	-----	---	----------------------------------	--	---	---	-----	---

$I_C = 5 \text{ mA}, V_{CE} = 6 \text{ V}, Z_0 = 50 \Omega$

0.01	0.85	—	(Z _s = 100 Ω)		—	—	1.1	—
0.8	1.3	15.5	0.28	79	12	0.19	1.5	14.8

Noise figure $F = f(Z_s)$

$V_{CE} = 6 \text{ V}, f = 10 \text{ MHz}$

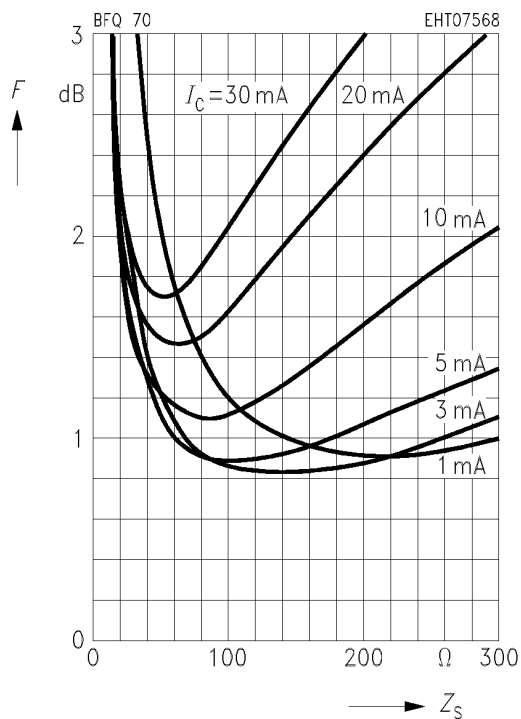

Circles of constant noise figure $F = f(Z_S)$
 in Z_S -plane, $I_C = 5 \text{ mA}$, $V_{CE} = 6 \text{ V}$, $f = 800 \text{ MHz}$

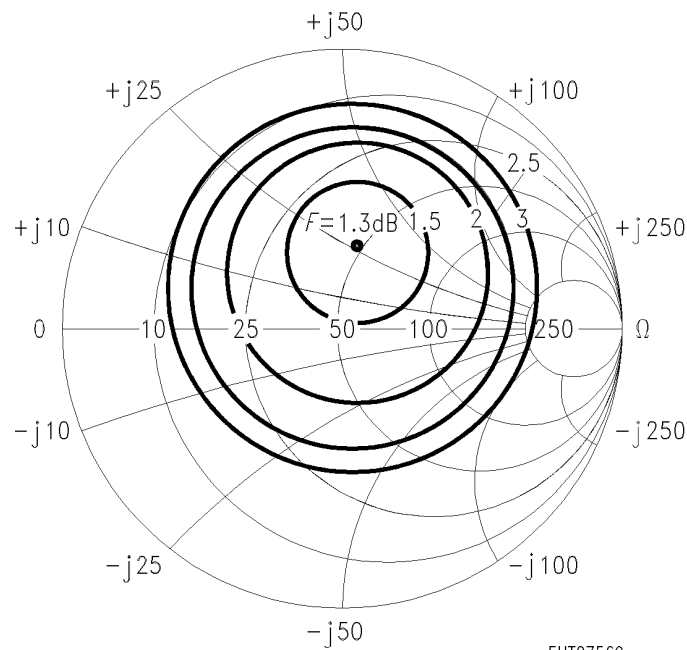

EHT07569

Noise figure $F = f(I_C)$
Power gain $G = f(I_C)$
 $V_{CE} = 6 \text{ V}$, $f = 800 \text{ MHz}$, $Z_{Lopt}(G)$

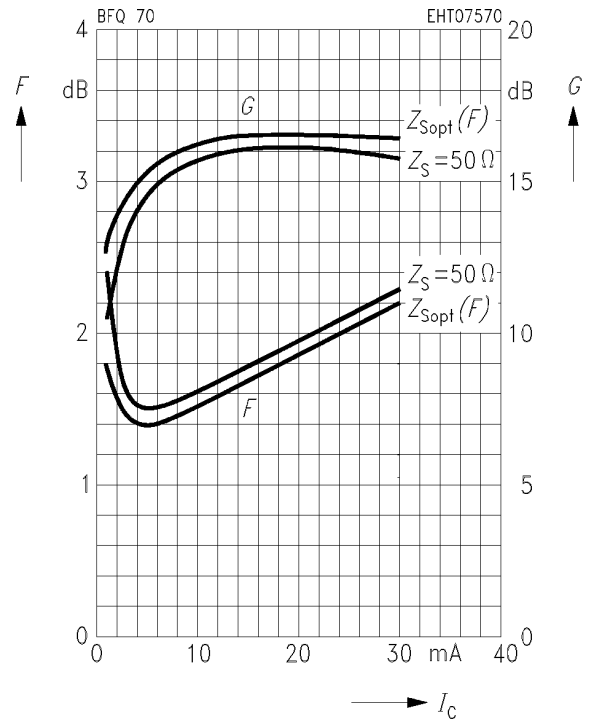

Common Emitter Power Gain

Power gain $G_{ms}, |S_{21e}|^2 = f(I_C)$

$V_{CE} = 6 \text{ V}, f = 200 \text{ MHz}, Z_0 = 50 \Omega$

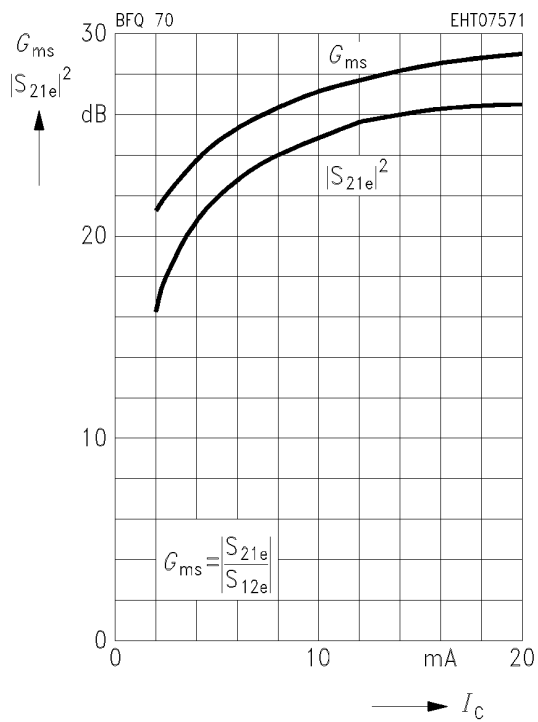

Power gain $G_{ms}, |S_{21e}|^2 = f(I_C)$

$V_{CE} = 6 \text{ V}, f = 500 \text{ MHz}, Z_0 = 50 \Omega$

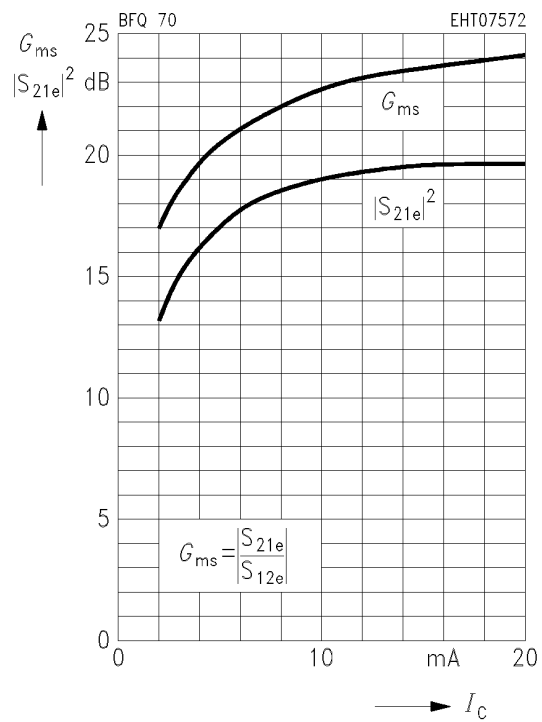

Power gain $G_{ms}, |S_{21e}|^2 = f(I_C)$

$V_{CE} = 6 \text{ V}, f = 800 \text{ MHz}, Z_0 = 50 \Omega$

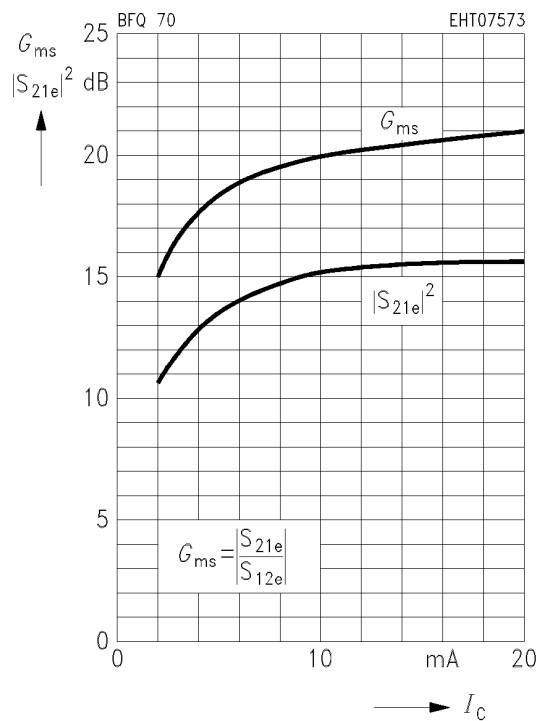

Power gain $G_{ma}, |S_{21e}|^2 = f(I_C)$

$V_{CE} = 6 \text{ V}, f = 1.5 \text{ GHz}, Z_0 = 50 \Omega$

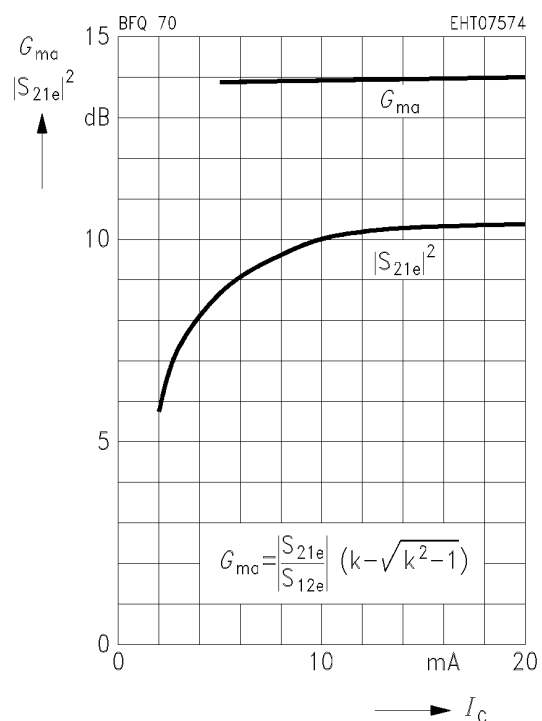

Power gain $G_{ms}, |S_{21e}|^2 = f(f)$

$I_C = 2 \text{ mA}, V_{CE} = 6 \text{ V}, Z_0 = 50 \Omega$

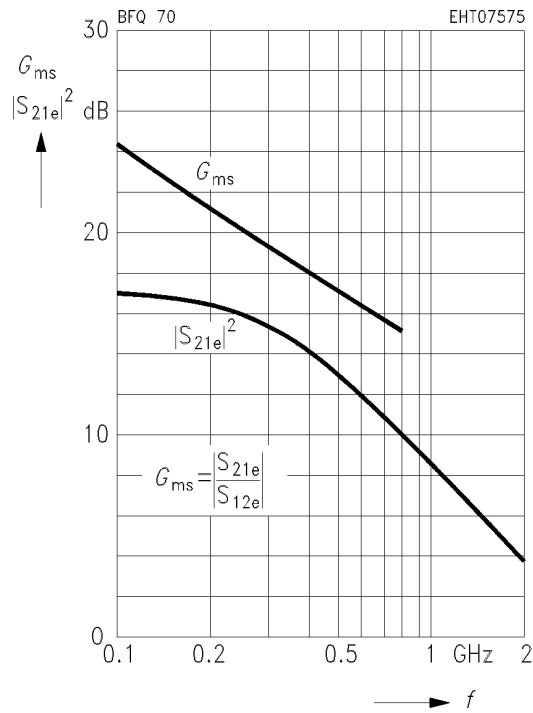

Power gain $G_{ma}, G_{ms}, |S_{21e}|^2 = f(f)$

$I_C = 5 \text{ mA}, V_{CE} = 6 \text{ V}, Z_0 = 50 \Omega$

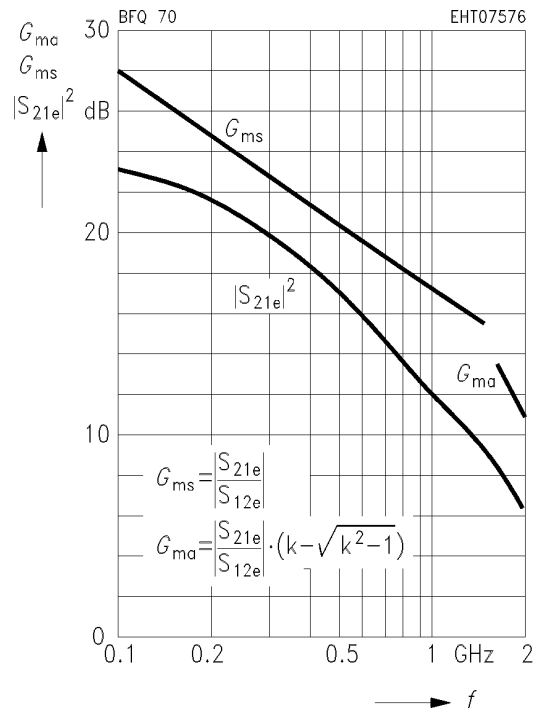

Power gain $G_{ma}, G_{ms}, |S_{21e}|^2 = f(f)$

$I_C = 10 \text{ mA}, V_{CE} = 6 \text{ V}, Z_0 = 50 \Omega$

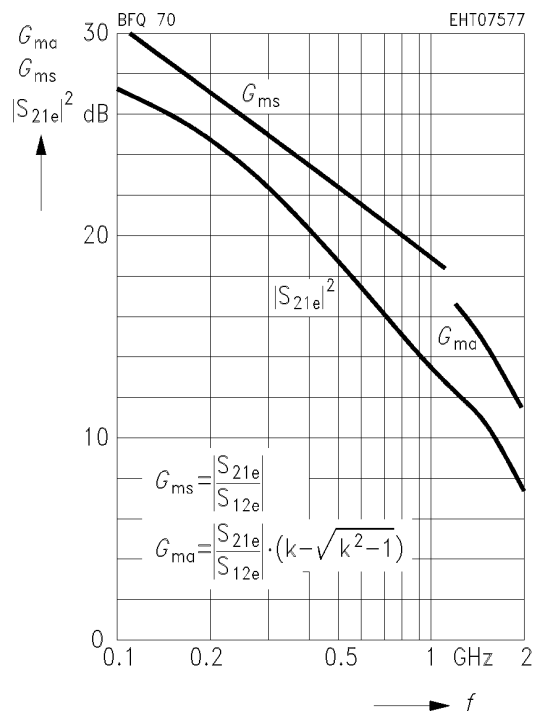

Power gain $G_{ma}, G_{ms}, |S_{21e}|^2 = f(f)$

$I_C = 20 \text{ mA}, V_{CE} = 6 \text{ V}, Z_0 = 50 \Omega$

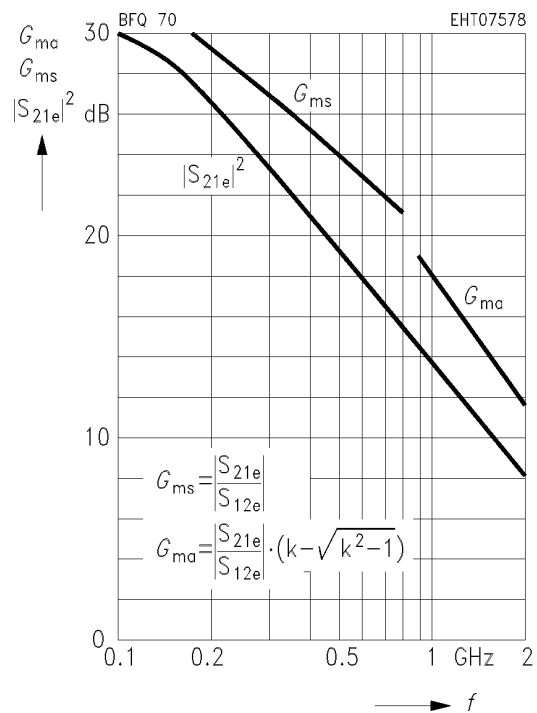

Common Emitter S Parameters

<i>f</i>	<i>S</i> ₁₁		<i>S</i> ₂₁		<i>S</i> ₁₂		<i>S</i> ₂₂	
	MAG	ANG	MAG	ANG	MAG	ANG	MAG	ANG
GHz								
<i>I</i> _C = 2 mA, <i>V</i> _{CE} = 6 V, <i>Z</i> ₀ = 50 Ω								
0.1	0.92	- 23	7.00	165	0.025	77	0.98	- 8
0.2	0.89	- 45	6.42	150	0.049	65	0.93	- 16
0.3	0.84	- 65	5.74	137	0.068	55	0.87	- 22
0.4	0.80	- 82	5.21	126	0.081	46	0.81	- 28
0.6	0.74	- 110	4.14	109	0.096	34	0.71	- 34
0.8	0.71	- 130	3.35	95	0.103	26	0.65	- 38
1.0	0.69	- 146	2.78	85	0.105	20	0.61	- 41
1.2	0.68	- 158	2.39	76	0.105	17	0.58	- 44
1.5	0.67	- 174	1.96	64	0.104	14	0.55	- 49
1.8	0.68	174	1.66	53	0.102	13	0.54	- 55
2.0	0.69	167	1.51	47	0.100	14	0.53	- 60
2.5	0.70	152	1.24	33	0.100	19	0.51	- 73
3.0	0.72	138	1.05	20	0.107	24	0.51	- 87

*S*₁₁, *S*₂₂ = *f* (*f*)

*I*_C = 2 mA, *V*_{CE} = 6 V, *Z*₀ = 50 Ω

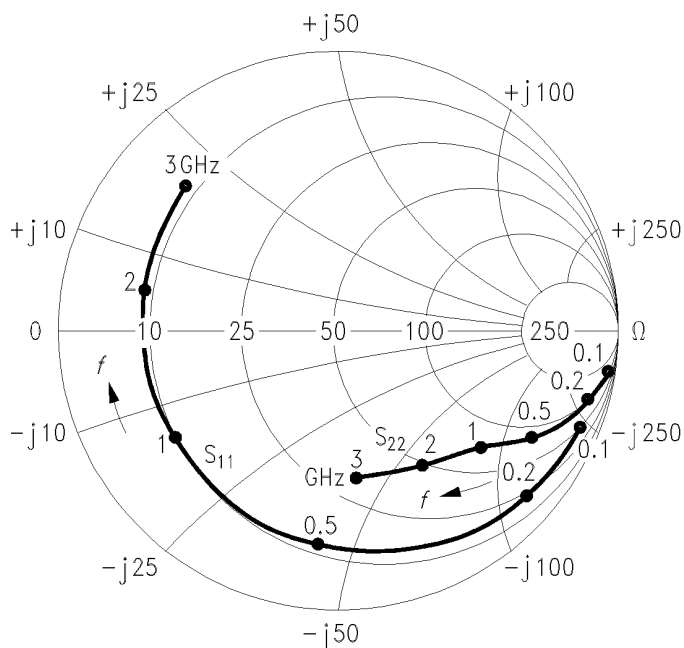

EHT07579

*S*₁₂, *S*₂₁ = *f* (*f*)

*I*_C = 2 mA, *V*_{CE} = 6 V, *Z*₀ = 50 Ω

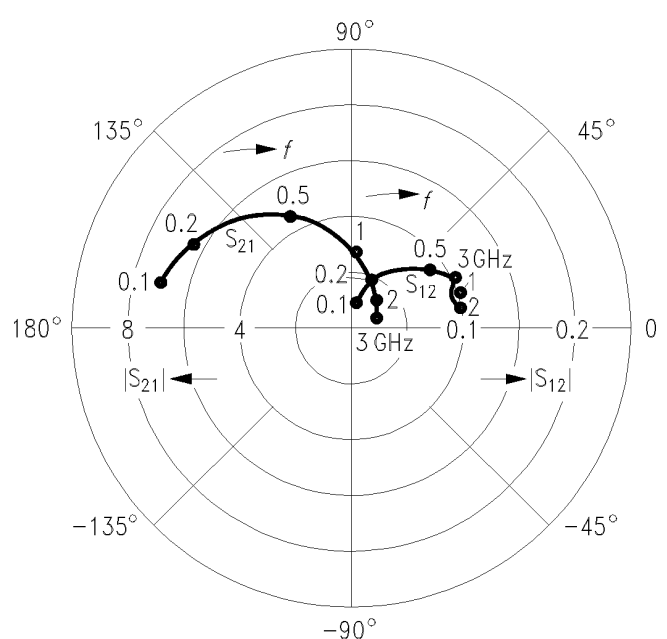

EHT07580

Common Emitter S Parameters (continued)

<i>f</i>	<i>S</i> ₁₁		<i>S</i> ₂₁		<i>S</i> ₁₂		<i>S</i> ₂₂	
	MAG	ANG	MAG	ANG	MAG	ANG	MAG	ANG
0.1	0.84	- 35	14.47	159	0.023	73	0.95	- 14
0.2	0.78	- 66	12.38	139	0.042	58	0.83	- 26
0.3	0.72	- 90	10.21	125	0.053	47	0.72	- 33
0.4	0.69	- 109	8.66	114	0.060	40	0.63	- 37
0.6	0.65	- 135	6.32	99	0.068	34	0.52	- 42
0.8	0.63	- 152	4.90	88	0.072	31	0.46	- 44
1.0	0.63	- 165	3.97	79	0.075	30	0.43	- 45
1.2	0.63	- 175	3.38	72	0.079	30	0.40	- 47
1.5	0.63	173	2.74	62	0.083	31	0.38	- 51
1.8	0.63	164	2.29	53	0.090	33	0.37	- 56
2.0	0.65	158	2.07	48	0.095	34	0.36	- 61
2.5	0.66	145	1.70	35	0.109	36	0.34	- 73
3.0	0.69	133	1.44	23	0.127	36	0.34	- 87

*I*_C = 5 mA, *V*_{CE} = 6 V, *Z*₀ = 50 Ω

*S*₁₁, *S*₂₂ = *f* (*f*)

*I*_C = 5 mA, *V*_{CE} = 6 V, *Z*₀ = 50 Ω

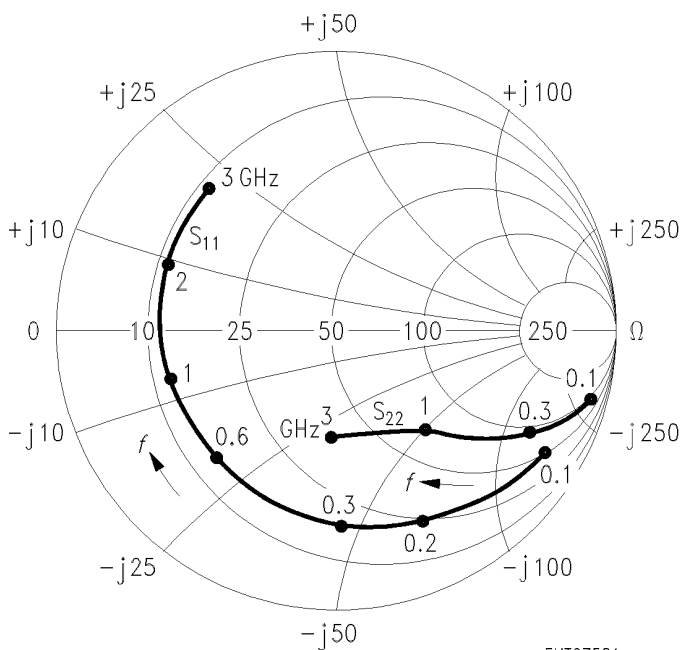

EHT07581

*S*₁₂, *S*₂₁ = *f* (*f*)

*I*_C = 5 mA, *V*_{CE} = 6 V, *Z*₀ = 50 Ω

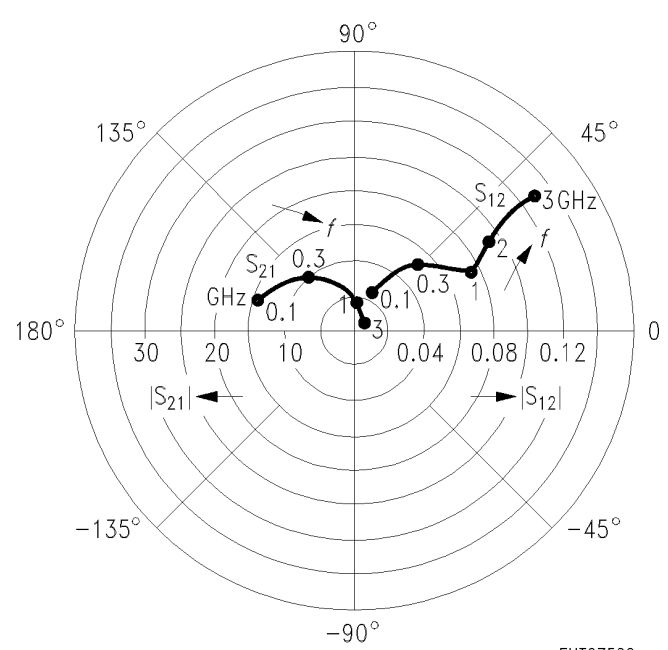

EHT07582

Common Emitter S Parameters (continued)

<i>f</i>	<i>S</i> ₁₁		<i>S</i> ₂₁		<i>S</i> ₁₂		<i>S</i> ₂₂		
	GHZ	MAG	ANG	MAG	ANG	MAG	ANG	MAG	ANG
<i>I</i> _C = 10 mA, <i>V</i> _{CE} = 6 V, <i>Z</i> ₀ = 50 Ω									
0.1	0.73	- 50	22.77	151	0.021	65	0.89	- 21	
0.2	0.67	- 89	17.57	129	0.034	52	0.71	- 34	
0.3	0.63	- 114	13.44	115	0.041	43	0.57	- 41	
0.4	0.62	- 132	10.84	105	0.045	41	0.49	- 44	
0.6	0.60	- 153	7.56	92	0.051	39	0.39	- 45	
0.8	0.60	- 167	5.75	83	0.057	40	0.35	- 46	
1.0	0.61	- 177	4.62	76	0.062	41	0.32	- 47	
1.2	0.61	175	3.90	70	0.068	43	0.30	- 48	
1.5	0.61	165	3.15	60	0.078	44	0.29	- 51	
1.8	0.62	157	2.62	52	0.089	44	0.28	- 56	
2.0	0.64	152	2.37	47	0.096	44	0.27	- 61	
2.5	0.65	141	1.94	35	0.117	44	0.25	- 73	
3.0	0.68	130	1.65	24	0.138	41	0.25	- 88	

*S*₁₁, *S*₂₂ = *f* (*f*)

*I*_C = 10 mA, *V*_{CE} = 6 V, *Z*₀ = 50 Ω

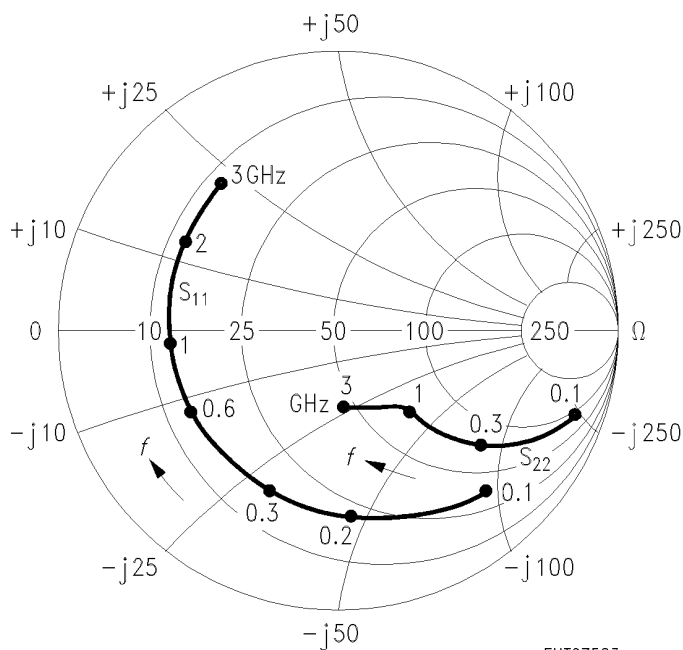

EHT07583

*S*₁₂, *S*₂₁ = *f* (*f*)

*I*_C = 10 mA, *V*_{CE} = 6 V, *Z*₀ = 50 Ω

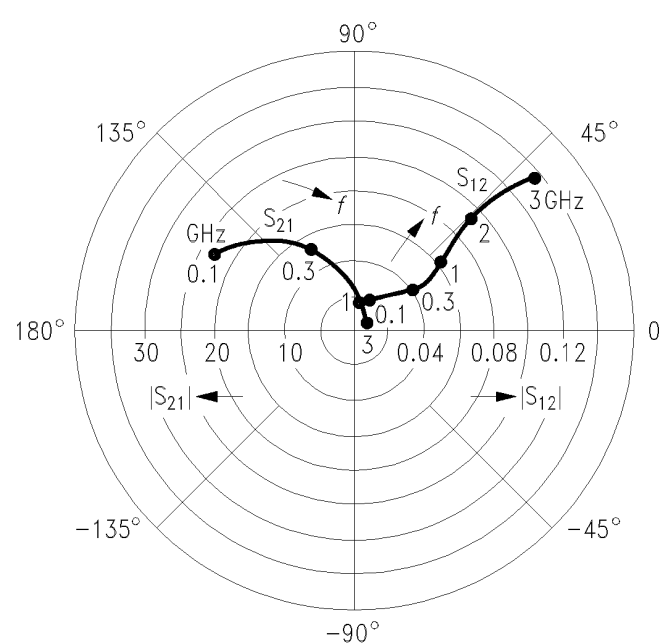

EHT07584

Common Emitter S Parameters (continued)

<i>f</i>	<i>S</i> ₁₁		<i>S</i> ₂₁		<i>S</i> ₁₂		<i>S</i> ₂₂		
	GHZ	MAG	ANG	MAG	ANG	MAG	ANG	MAG	ANG
<i>I</i> _C = 15 mA, <i>V</i> _{CE} = 6 V, <i>Z</i> ₀ = 50 Ω									
0.1	0.67	- 62	27.86	146	0.019	64	0.84	- 25	
0.2	0.62	- 104	20.01	123	0.029	49	0.63	- 38	
0.3	0.59	- 128	14.73	110	0.035	44	0.50	- 43	
0.4	0.60	- 143	11.63	101	0.038	43	0.42	- 44	
0.6	0.59	- 162	7.97	89	0.045	44	0.34	- 45	
0.8	0.59	- 173	6.02	81	0.051	46	0.30	- 45	
1.0	0.60	178	4.82	75	0.058	48	0.28	- 45	
1.2	0.60	171	4.07	68	0.065	49	0.27	- 47	
1.5	0.61	162	3.28	60	0.077	50	0.25	- 50	
1.8	0.62	154	2.73	52	0.090	49	0.25	- 55	
2.0	0.63	150	2.47	47	0.097	49	0.24	- 60	
2.5	0.65	139	2.02	35	0.120	47	0.22	- 72	
3.0	0.68	128	1.71	24	0.142	43	0.22	- 87	

*S*₁₁, *S*₂₂ = *f* (*f*)

*I*_C = 15 mA, *V*_{CE} = 6 V, *Z*₀ = 50 Ω

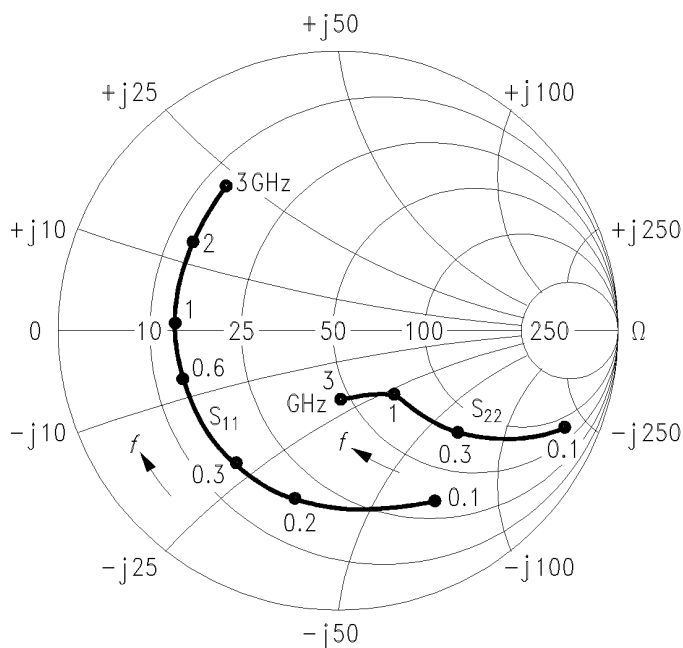

EHT07585

*S*₁₂, *S*₂₁ = *f* (*f*)

*I*_C = 15 mA, *V*_{CE} = 6 V, *Z*₀ = 50 Ω

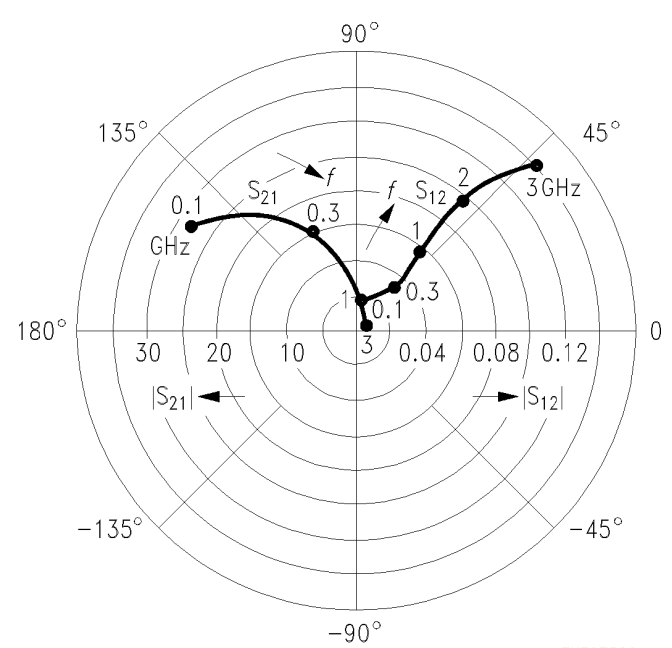

EHT07586

Common Emitter S Parameters (continued)

<i>f</i>	<i>S</i> ₁₁		<i>S</i> ₂₁		<i>S</i> ₁₂		<i>S</i> ₂₂	
	MAG	ANG	MAG	ANG	MAG	ANG	MAG	ANG
0.1	0.63	- 71	31.01	142	0.017	59	0.81	- 28
0.2	0.60	- 113	21.18	119	0.026	48	0.58	- 40
0.3	0.58	- 136	15.24	107	0.031	45	0.45	- 43
0.4	0.59	- 150	11.90	98	0.034	45	0.38	- 44
0.6	0.59	- 166	8.08	88	0.041	47	0.32	- 43
0.8	0.59	- 177	6.09	80	0.048	50	0.29	- 43
1.0	0.60	175	4.87	74	0.056	52	0.27	- 44
1.2	0.60	169	4.11	68	0.064	53	0.26	- 45
1.5	0.61	160	3.31	59	0.076	53	0.25	- 48
1.8	0.62	153	2.75	51	0.089	52	0.24	- 54
2.0	0.64	149	2.49	47	0.098	51	0.23	- 58
2.5	0.65	138	2.03	35	0.120	49	0.21	- 70
3.0	0.68	128	1.72	24	0.143	44	0.21	- 86

*I*_C = 20 mA, *V*_{CE} = 6 V, *Z*₀ = 50 Ω

*S*₁₁, *S*₂₂ = *f* (*f*)

*I*_C = 20 mA, *V*_{CE} = 6 V, *Z*₀ = 50 Ω

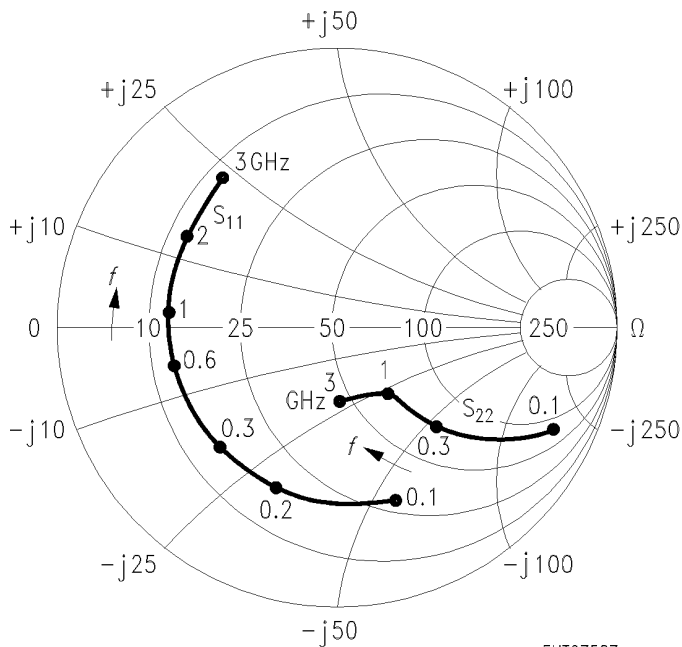

EHT07587

*S*₁₂, *S*₂₁ = *f* (*f*)

*I*_C = 20 mA, *V*_{CE} = 6 V, *Z*₀ = 50 Ω

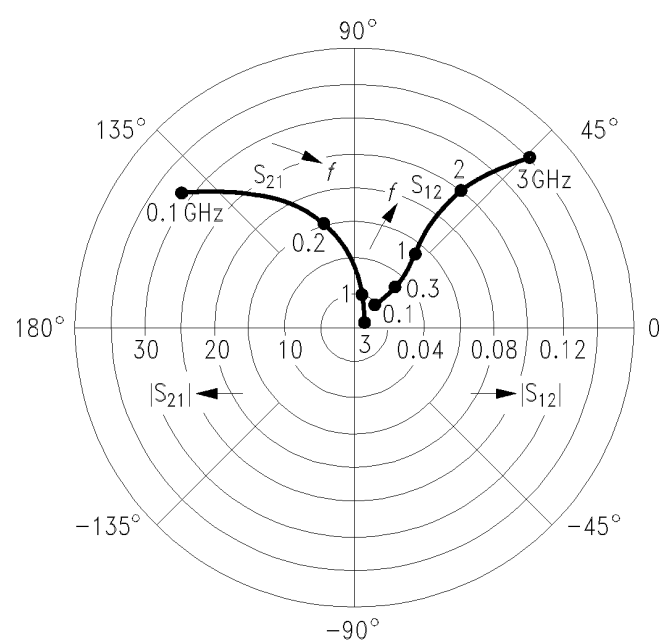

EHT07588

Common Emitter S Parameters (continued)

f	S_{11}		S_{21}		S_{12}		S_{22}	
	MAG	ANG	MAG	ANG	MAG	ANG	MAG	ANG
0.1	0.75	- 45	22.64	153	0.018	67	0.91	- 18
0.2	0.69	- 83	17.84	131	0.030	53	0.75	- 29
0.3	0.63	- 109	13.82	117	0.037	45	0.63	- 34
0.4	0.62	- 127	11.23	107	0.041	42	0.55	- 36
0.6	0.59	- 149	7.88	93	0.046	40	0.46	- 37
0.8	0.59	- 164	6.01	84	0.051	41	0.42	- 37
1.0	0.59	- 174	4.83	77	0.056	43	0.40	- 38
1.2	0.59	178	4.09	70	0.061	44	0.38	- 40
1.5	0.59	167	3.29	61	0.070	46	0.37	- 43
1.8	0.60	159	2.75	53	0.080	47	0.37	- 48
2.0	0.62	153	2.49	48	0.087	47	0.36	- 52
2.5	0.63	142	2.03	36	0.106	47	0.34	- 62
3.0	0.66	131	1.73	25	0.126	45	0.33	- 75

$I_C = 10 \text{ mA}$, $V_{CE} = 10 \text{ V}$, $Z_0 = 50 \Omega$

$S_{11}, S_{22} = f(f)$

$I_C = 10 \text{ mA}$, $V_{CE} = 10 \text{ V}$, $Z_0 = 50 \Omega$

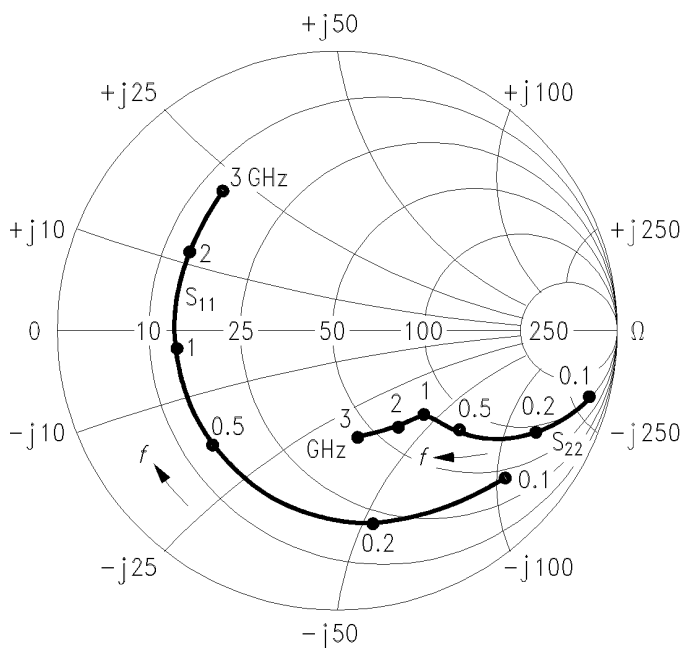

EHT07589

$S_{12}, S_{21} = f(f)$

$I_C = 10 \text{ mA}$, $V_{CE} = 10 \text{ V}$, $Z_0 = 50 \Omega$

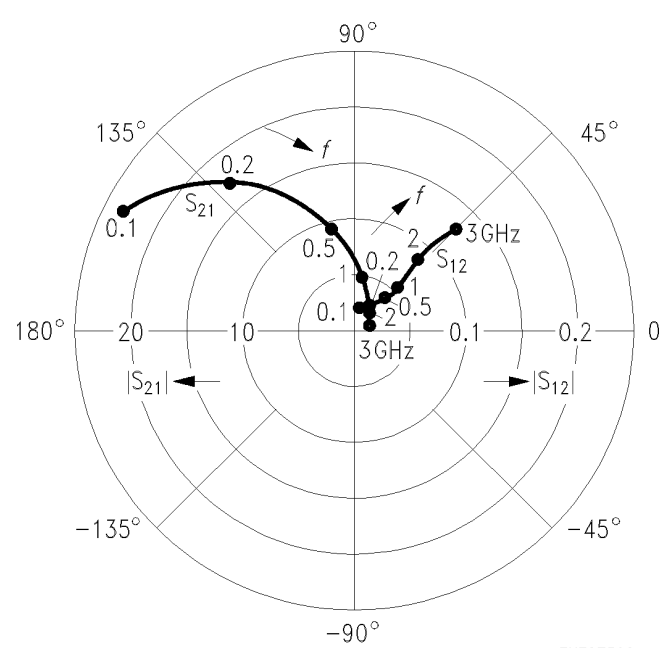

EHT07590