

## NPN Silicon RF Transistor

**BFQ 73S**

- For low-noise, low-distortion broadband amplifiers in antenna and telecommunications systems up to 2 GHz at collector currents from 10 mA to 70 mA.
- Hermetically sealed ceramic package.
- HiRel/Mil screening available.
- CECC-type available: CECC 50002/261.

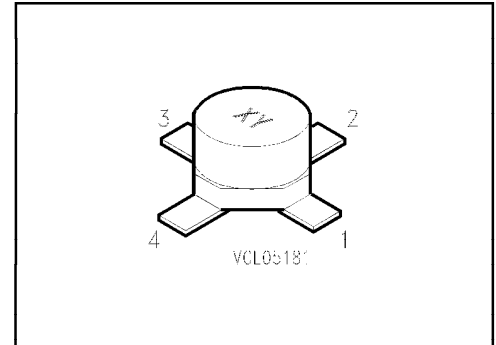

**ESD: Electrostatic discharge sensitive device, observe handling precautions!**

Type	Marking	Ordering Code (tape and reel)	Pin Configuration				Package <sup>1)</sup>
			1	2	3	4	
BFQ 73S	73S	Q62702-F1104	B	E	C	E	Cerrec-X

### Maximum Ratings

Parameter	Symbol	Values	Unit
Collector-emitter voltage	$V_{CE0}$	15	V
Collector-base voltage	$V_{CB0}$	20	
Emitter-base voltage	$V_{EB0}$	3	
Collector current	$I_C$	100	mA
Total power dissipation, $T_s \leq 110\text{ °C}^3)$	$P_{tot}$	500	mW
Junction temperature	$T_j$	175	°C
Ambient temperature range	$T_A$	- 65 ... + 175	
Storage temperature range	$T_{stg}$	- 65 ... + 175	

### Thermal Resistance

Junction - ambient <sup>2)</sup>	$R_{th\ JA}$	$\leq 210$	K/W
Junction - soldering point <sup>3)</sup>	$R_{th\ JS}$	$\leq 130$	

1) For detailed information see chapter Package Outlines.

2) Package mounted on alumina  $15\text{ mm} \times 16.7\text{ mm} \times 0.7\text{ mm}$ .

3)  $T_s$  is measured on the collector lead at the soldering point to the pcb.

**Electrical Characteristics**at  $T_A = 25\text{ °C}$ , unless otherwise specified.

Parameter	Symbol	Values			Unit
		min.	typ.	max.	

**DC Characteristics**

Collector-emitter breakdown voltage $I_C = 1\text{ mA}$ , $I_B = 0$	$V_{(BR)CE0}$	15	–	–	V
Collector-base cutoff current $V_{CB} = 10\text{ V}$ , $I_E = 0$	$I_{CB0}$	–	–	100	nA
Emitter-base cutoff current $V_{EB} = 2\text{ V}$ , $I_C = 0$	$I_{EB0}$	–	–	10	$\mu\text{A}$
DC current gain $I_C = 50\text{ mA}$ , $V_{CE} = 5\text{ V}$	$h_{FE}$	30	90	250	–
Collector-emitter saturation voltage $I_C = 75\text{ mA}$ , $I_B = 7.5\text{ mA}$	$V_{CEsat}$	–	0.2	0.5	V

## Electrical Characteristics

at  $T_A = 25\text{ }^\circ\text{C}$ , unless otherwise specified.

Parameter	Symbol	Values			Unit
		min.	typ.	max.	

## AC Characteristics

Transition frequency $I_C = 50\text{ mA}$ , $V_{CE} = 5\text{ V}$ , $f = 200\text{ MHz}$ $I_C = 75\text{ mA}$ , $V_{CE} = 5\text{ V}$ , $f = 200\text{ MHz}$	$f$	–	5.3 5.4	–	GHz
Collector-base capacitance $V_{CB} = 10\text{ V}$ , $V_{BE} = v_{be} = 0$ , $f = 1\text{ MHz}$	$C_{cb}$	–	0.9	–	pF
Collector-emitter capacitance $V_{CE} = 10\text{ V}$ , $V_{BE} = v_{be} = 0$ , $f = 1\text{ MHz}$	$C_{ce}$	–	0.4	–	
Input capacitance $V_{EB} = 0.5\text{ V}$ , $I_C = i_c = 0$ , $f = 1\text{ MHz}$	$C_{ibo}$	–	5	–	
Output capacitance $V_{CE} = 10\text{ V}$ , $V_{BE} = v_{be} = 0$ , $f = 1\text{ MHz}$	$C_{obs}$	–	1.3	–	
Noise figure $I_C = 5\text{ mA}$ , $V_{CE} = 10\text{ V}$ , $f = 10\text{ MHz}$ , $Z_S = 50\text{ }\Omega$ $I_C = 50\text{ mA}$ , $V_{CE} = 5\text{ V}$ , $f = 800\text{ MHz}$ , $Z_S = Z_{Sopt}$	$F$	–	0.9 2.5	–	dB
Power gain $I_C = 50\text{ mA}$ , $V_{CE} = 5\text{ V}$ , $f = 800\text{ MHz}$ , $Z_S = Z_{Sopt}$ , $Z_L = Z_{Lopt}$	$G_{pe}$	–	15	–	
Transducer gain $I_C = 50\text{ mA}$ , $V_{CE} = 5\text{ V}$ , $f = 1\text{ GHz}$ , $Z_0 = 50\text{ }\Omega$	$ S_{21e} ^2$	–	10.5	–	
Linear output voltage two-tone intermodulation test $I_C = 50\text{ mA}$ , $V_{CE} = 10\text{ V}$ , $d_{IM} = 60\text{ dB}$ $f_1 = 806\text{ MHz}$ , $f_2 = 810\text{ MHz}$ , $Z_S = Z_L = 50\text{ }\Omega$	$V_{o1} = V_{o2}$	–	400	–	mV
Third order intercept point $I_C = 50\text{ mA}$ , $V_{CE} = 10\text{ V}$ , $f = 800\text{ MHz}$	$IP_3$	–	35	–	dBm

### Total power dissipation $P_{tot} = f(T_A^*; T_S)$

\* Package mounted on alumina

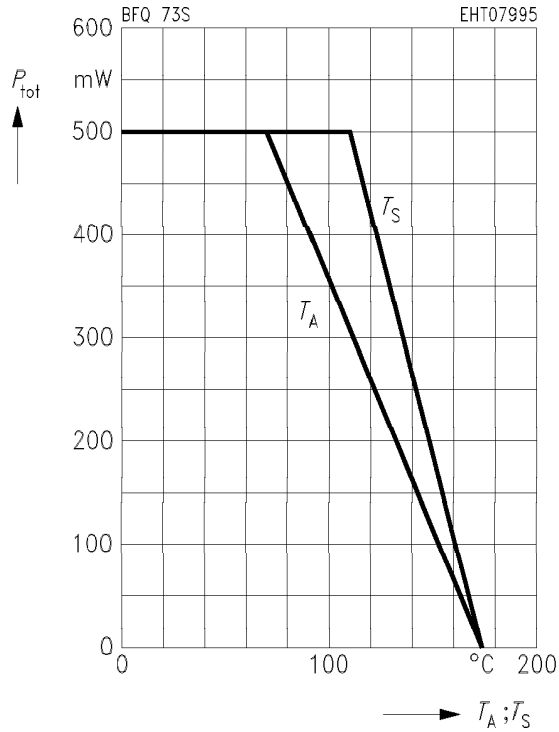

### Transition frequency $f_T = f(I_C)$

$V_{CE} = 5\text{ V}, f = 200\text{ MHz}$

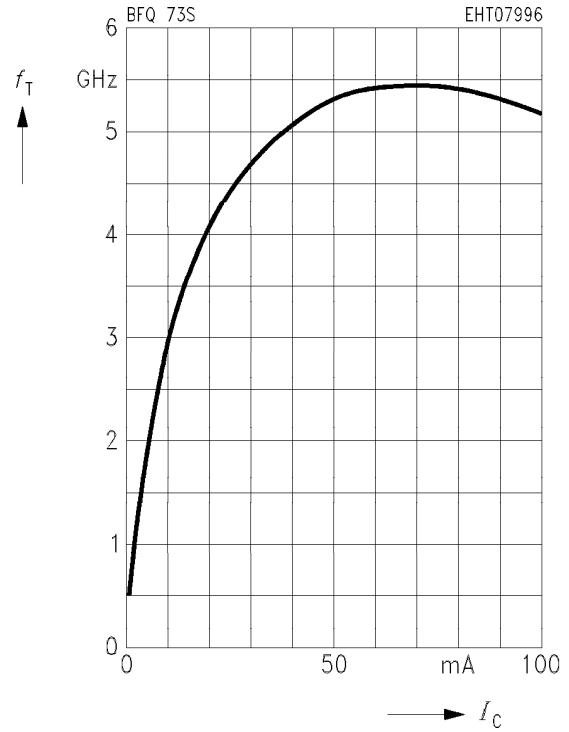

### Collector-base capacitance $C_{cb} = f(V_{CB})$

$V_{BE} = v_{be} = 0, f = 1\text{ MHz}$

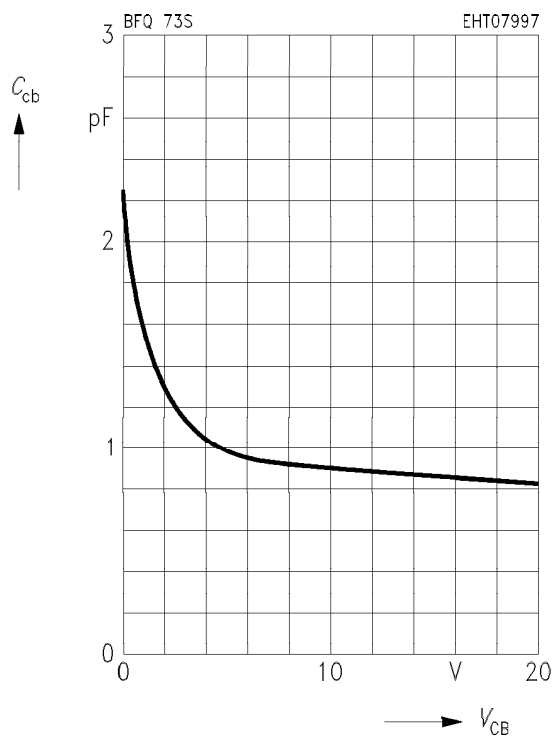

### Common Emitter Noise Parameters

$f$	$F_{min}$	$G_p(F_{min})$	$\Gamma_{opt}$		$R_N$	$N$	$F_{50\Omega}$	$G_p(F_{50\Omega})$
GHz	dB	dB	MAG	ANG	$\Omega$	—	dB	dB

$I_C = 5 \text{ mA}, V_{CE} = 5 \text{ V}, Z_0 = 50 \Omega$

0.01	0.9	—	(Z <sub>s</sub> = 50 Ω)		—	—	—	—
------	-----	---	-------------------------	--	---	---	---	---

$I_C = 50 \text{ mA}, V_{CE} = 5 \text{ V}, Z_0 = 50 \Omega$

0.01	2.0	—	(Z <sub>s</sub> = 50 Ω)		—	—	—	—
0.8	2.5	14	0.41	163	9	0.39	3.8	—

### Noise figure $F = f(I_C)$

$V_{CE} = 10 \text{ V}, f = 10 \text{ MHz}, Z_S = 50 \Omega$

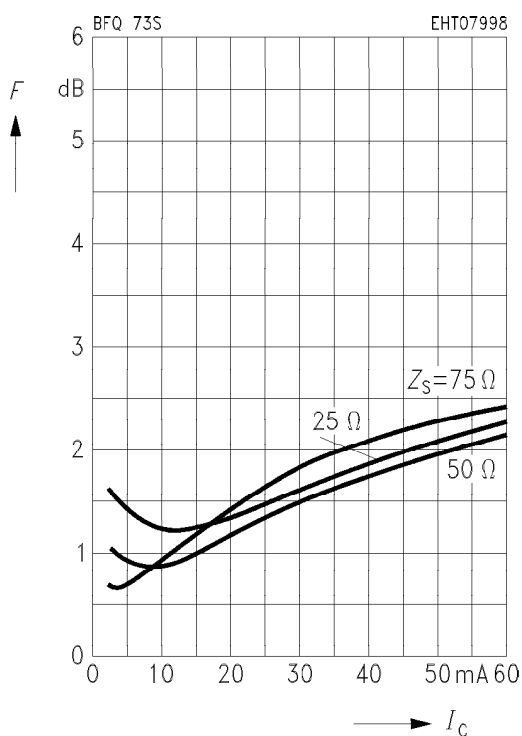

### Noise figure $F = f(I_C)$

$V_{CE} = 5 \text{ V}, f = 800 \text{ MHz}$

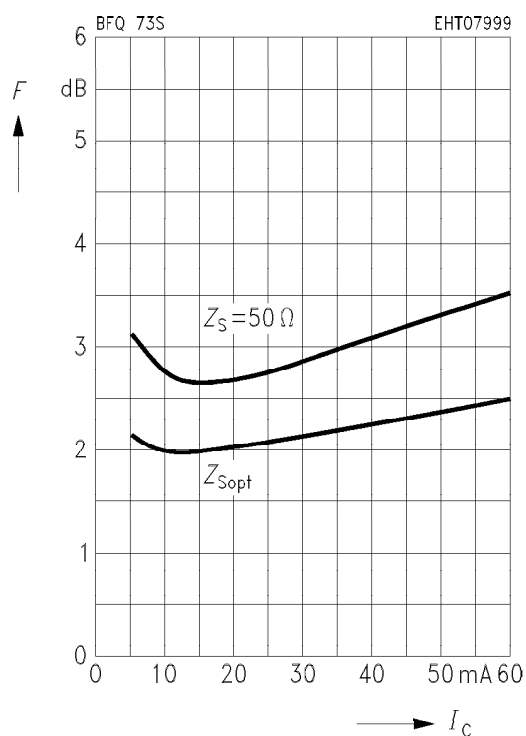

**Circles of constant noise figure  $F = f(Z_s)$   
and available power gain  $G_{av} = f(Z_s)$**

$I_C = 50 \text{ mA}$ ,  $V_{CE} = 5 \text{ V}$ ,  $f = 800 \text{ MHz}$ ,

$Z_0 = 50 \Omega$

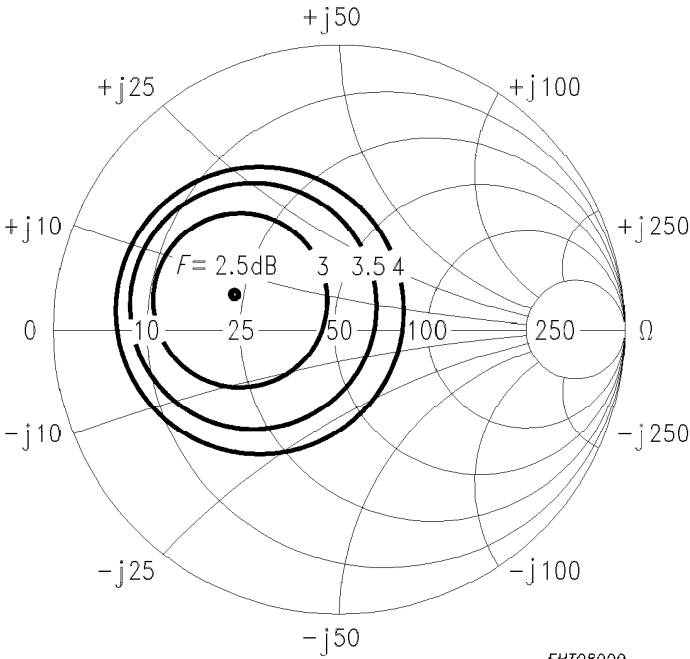

**Common Emitter Power Gain**

**Power gain  $G_{ms}$ ,  $|S_{21e}|^2 = f(I_c)$**   
 $V_{CE} = 5\text{ V}$ ,  $f = 200\text{ MHz}$ ,  $Z_0 = 50\ \Omega$

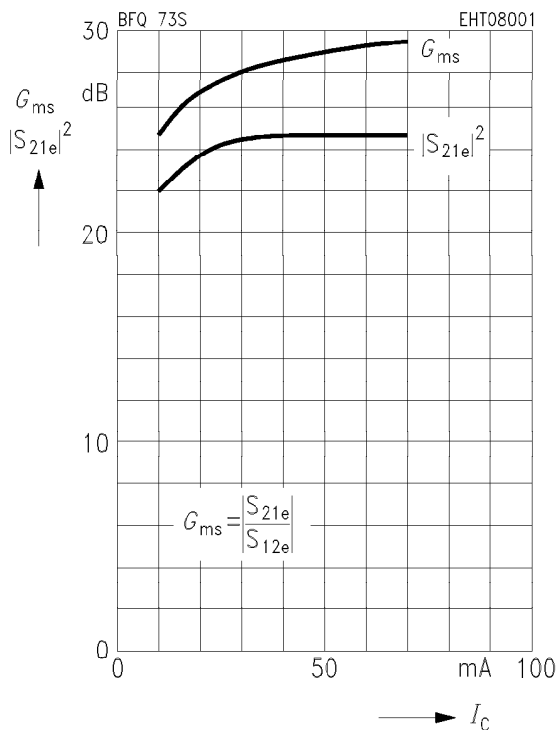

**Power gain  $G_{ms}$ ,  $|S_{21e}|^2 = f(I_c)$**   
 $V_{CE} = 5\text{ V}$ ,  $f = 500\text{ MHz}$ ,  $Z_0 = 50\ \Omega$

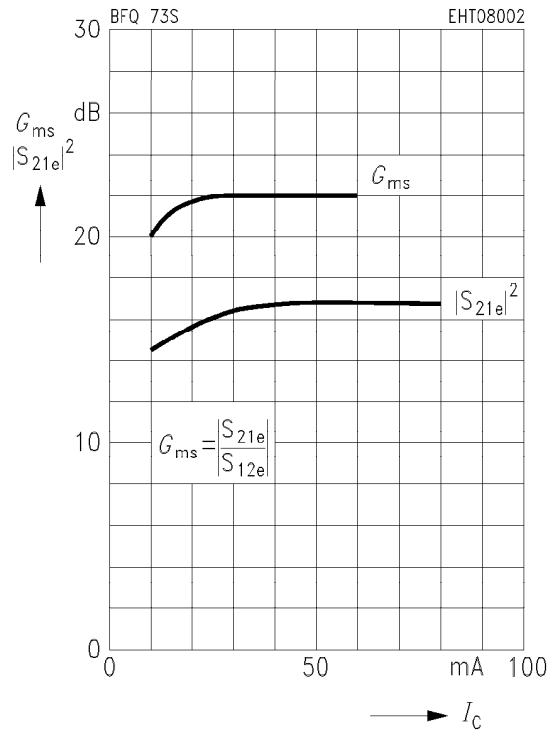

**Power gain  $G_{ma}$ ,  $|S_{21e}|^2 = f(I_c)$**   
 $V_{CE} = 5\text{ V}$ ,  $f = 800\text{ MHz}$ ,  $Z_0 = 50\ \Omega$

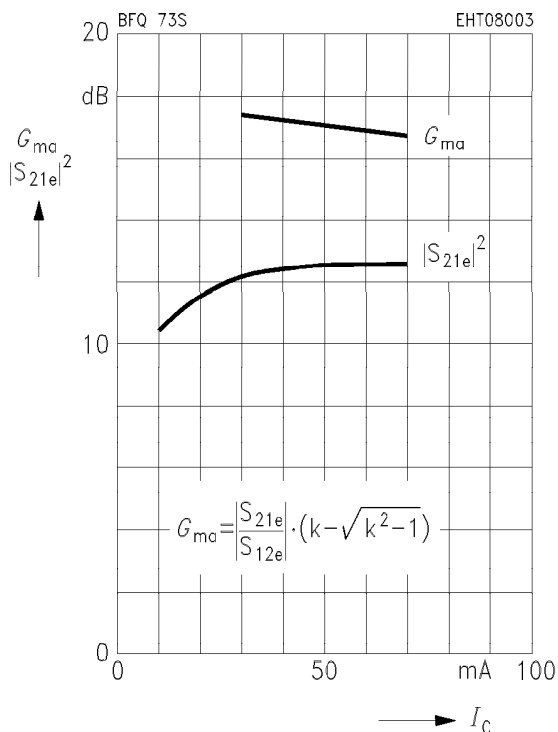

**Power gain  $G_{ma}$ ,  $|S_{21e}|^2 = f(I_c)$**   
 $V_{CE} = 5\text{ V}$ ,  $f = 1.5\text{ GHz}$ ,  $Z_0 = 50\ \Omega$

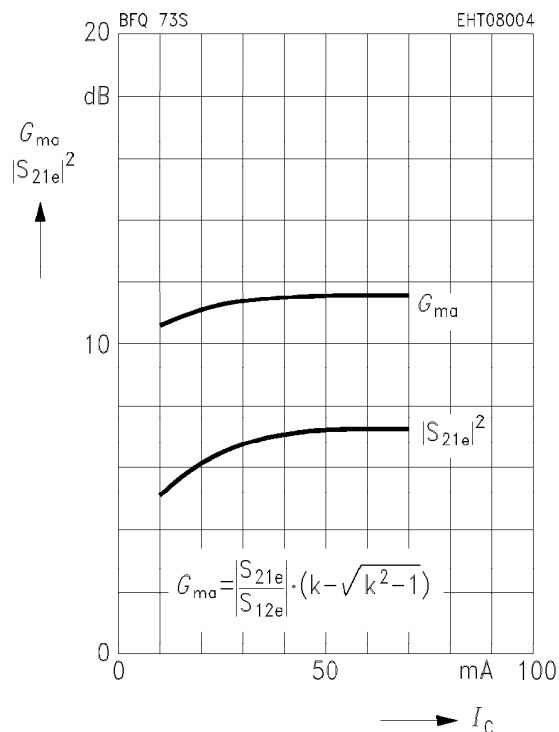

**Power gain  $G_{ma}$ ,  $G_{ms}$ ,  $|S_{21e}|^2 = f(f)$**   
 $I_C = 10 \text{ mA}$ ,  $V_{CE} = 5 \text{ V}$ ,  $Z_0 = 50 \Omega$

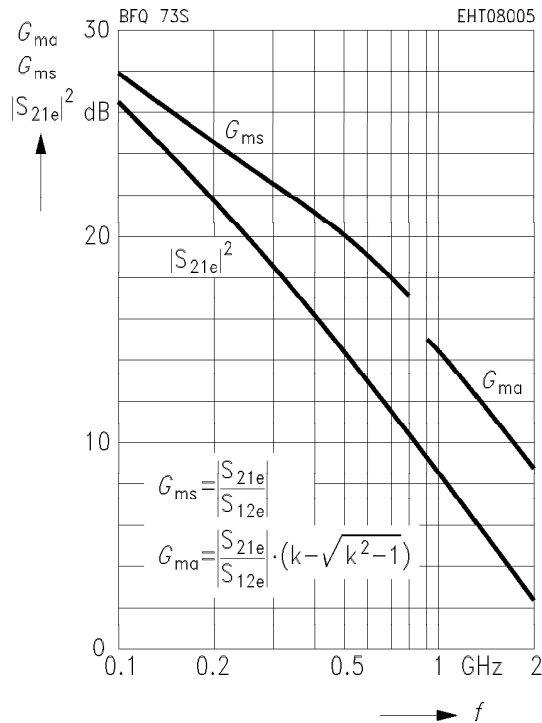

**Power gain  $G_{ma}$ ,  $G_{ms}$ ,  $|S_{21e}|^2 = f(f)$**   
 $I_C = 30 \text{ mA}$ ,  $V_{CE} = 5 \text{ V}$ ,  $Z_0 = 50 \Omega$

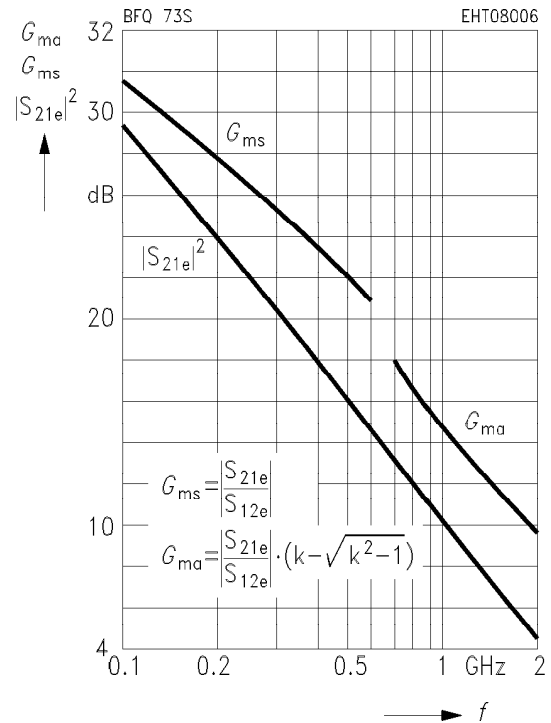

**Power gain  $G_{ma}$ ,  $G_{ms}$ ,  $|S_{21e}|^2 = f(f)$**   
 $I_C = 50 \text{ mA}$ ,  $V_{CE} = 5 \text{ V}$ ,  $Z_0 = 50 \Omega$

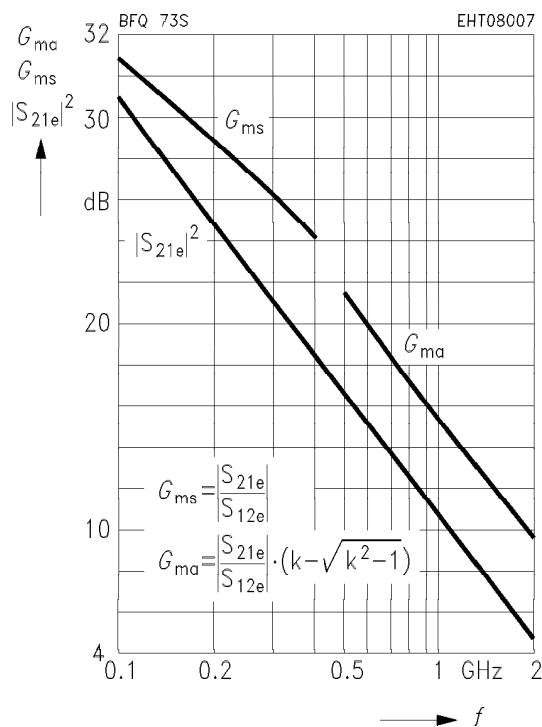

**Power gain  $G_{ma}$ ,  $G_{ms}$ ,  $|S_{21e}|^2 = f(f)$**   
 $I_C = 70 \text{ mA}$ ,  $V_{CE} = 5 \text{ V}$ ,  $Z_0 = 50 \Omega$

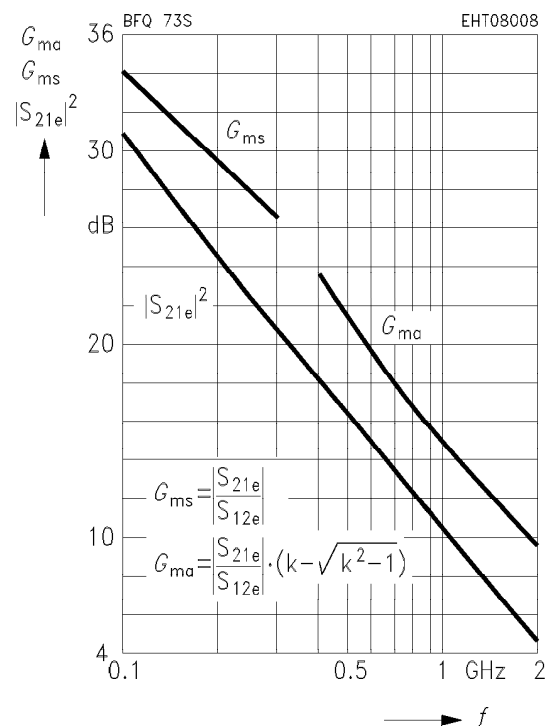



### Common Emitter S Parameters

$f$	$S_{11}$		$S_{21}$		$S_{12}$		$S_{22}$	
GHz	MAG	ANG	MAG	ANG	MAG	ANG	MAG	ANG
$I_C = 10 \text{ mA}, V_{CE} = 5 \text{ V}, Z_0 = 50 \Omega$								
0.1	0.78	- 92	20.39	132	0.034	48	0.71	- 39
0.3	0.75	- 152	8.63	97	0.047	30	0.34	- 57
0.5	0.75	- 169	5.27	84	0.053	31	0.26	- 61
0.8	0.75	177	3.29	71	0.060	35	0.23	- 68
1.0	0.76	171	2.63	63	0.066	39	0.22	- 73
1.2	0.77	165	2.21	57	0.073	42	0.22	- 79
1.4	0.77	159	1.91	50	0.081	43	0.23	- 84
1.6	0.77	155	1.68	44	0.089	45	0.24	- 91
1.8	0.78	151	1.49	38	0.098	45	0.25	- 98
2.0	0.79	147	1.34	32	0.107	46	0.26	- 106

$S_{11}, S_{22} = f(f)$

$I_C = 10 \text{ mA}, V_{CE} = 5 \text{ V}, Z_0 = 50 \Omega$

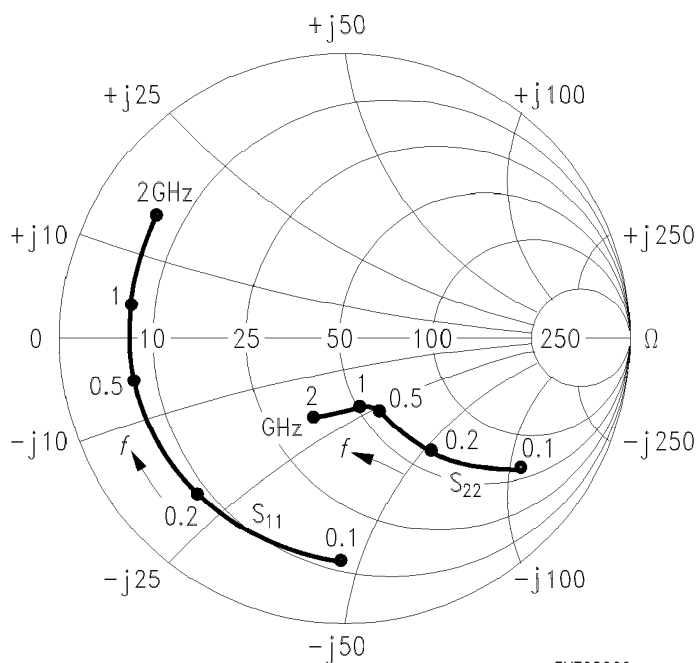

EHT08009

$S_{12}, S_{21} = f(f)$

$I_C = 10 \text{ mA}, V_{CE} = 5 \text{ V}, Z_0 = 50 \Omega$

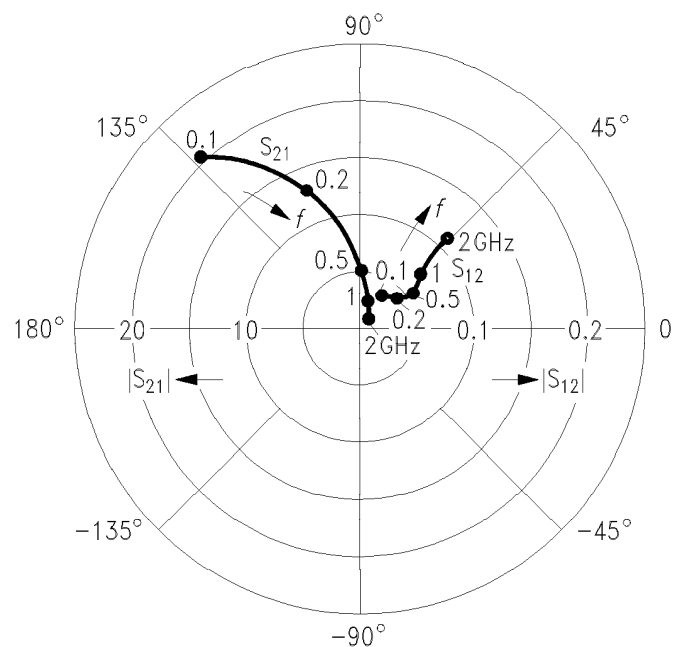

EHT08010

Common Emitter S Parameters (continued)

$f$	$S_{11}$		$S_{21}$		$S_{12}$		$S_{22}$	
GHz	MAG	ANG	MAG	ANG	MAG	ANG	MAG	ANG
$I_C = 30 \text{ mA}, V_{CE} = 5 \text{ V}, Z_0 = 50 \Omega$								
0.1	0.72	- 30	31.12	117	0.022	44	0.49	- 66
0.3	0.73	- 168	11.01	91	0.029	45	0.20	- 103
0.5	0.74	- 179	6.61	82	0.040	51	0.15	- 119
0.8	0.73	170	4.10	71	0.056	55	0.14	- 132
1.0	0.75	166	3.27	64	0.067	56	0.13	- 139
1.2	0.75	161	2.75	59	0.079	56	0.13	- 144
1.4	0.76	156	2.38	53	0.090	55	0.14	- 146
1.6	0.75	152	2.09	47	0.102	54	0.14	- 148
1.8	0.76	149	1.85	41	0.113	52	0.16	- 152
2.0	0.78	145	1.67	36	0.123	51	0.17	- 157

$S_{11}, S_{22} = f(f)$   
 $I_C = 30 \text{ mA}, V_{CE} = 5 \text{ V}, Z_0 = 50 \Omega$

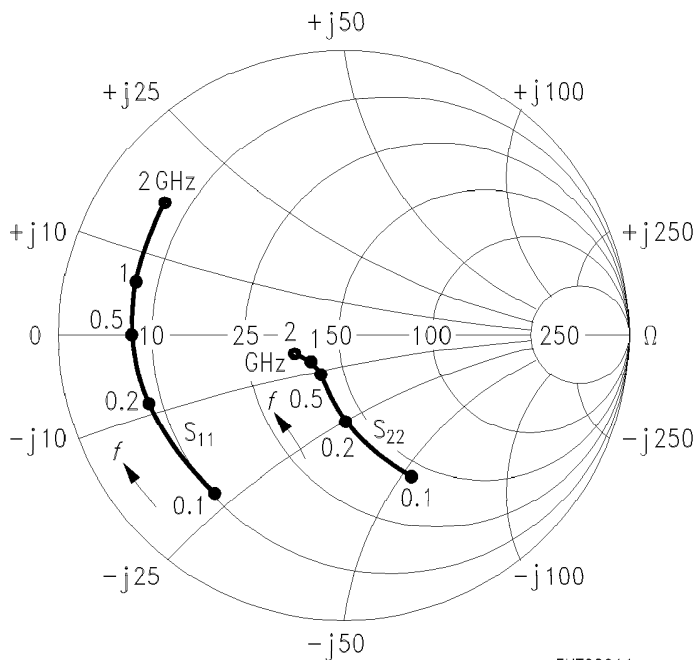

EHT08011

$S_{12}, S_{21} = f(f)$   
 $I_C = 30 \text{ mA}, V_{CE} = 5 \text{ V}, Z_0 = 50 \Omega$

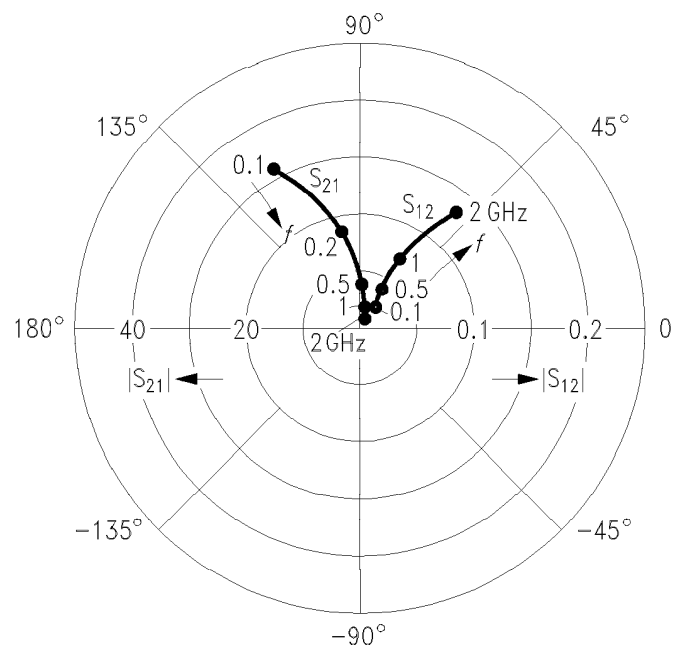

EHT08012

### Common Emitter S Parameters (continued)

$f$	$S_{11}$		$S_{21}$		$S_{12}$		$S_{22}$	
	MAG	ANG	MAG	ANG	MAG	ANG	MAG	ANG
0.1	0.72	-142	33.86	111	0.018	43	0.42	-79
0.3	0.73	-173	11.49	90	0.027	52	0.19	-122
0.5	0.73	177	6.87	81	0.038	58	0.16	-139
0.8	0.73	169	4.25	70	0.056	60	0.15	-152
1.0	0.75	165	3.39	64	0.068	60	0.15	-158
1.2	0.75	160	2.85	59	0.080	59	0.15	-162
1.4	0.75	155	2.46	53	0.092	58	0.15	-165
1.6	0.75	152	2.16	48	0.105	56	0.16	-166
1.8	0.75	148	1.92	42	0.116	53	0.17	-169
2.0	0.78	144	1.72	37	0.126	52	0.18	-172

$I_C = 50 \text{ mA}, V_{CE} = 5 \text{ V}, Z_0 = 50 \Omega$

$S_{11}, S_{22} = f(f)$   
 $I_C = 50 \text{ mA}, V_{CE} = 5 \text{ V}, Z_0 = 50 \Omega$

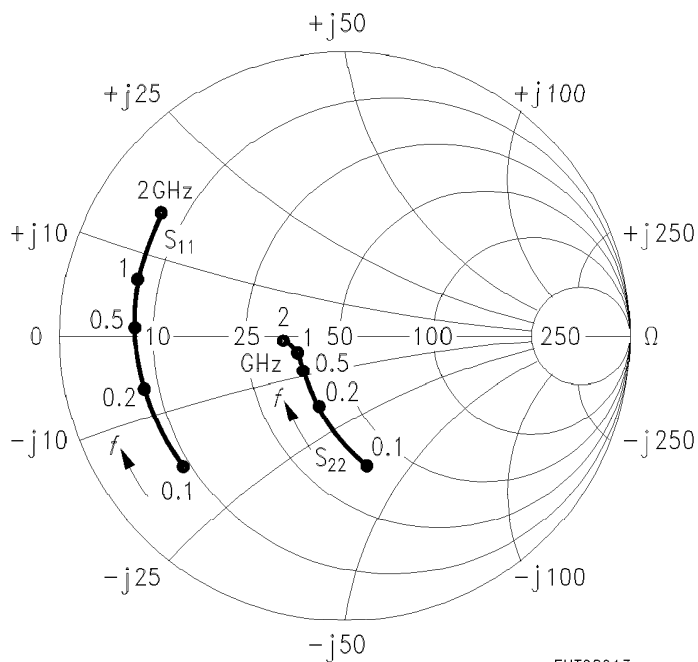

EHT08013

$S_{12}, S_{21} = f(f)$   
 $I_C = 50 \text{ mA}, V_{CE} = 5 \text{ V}, Z_0 = 50 \Omega$

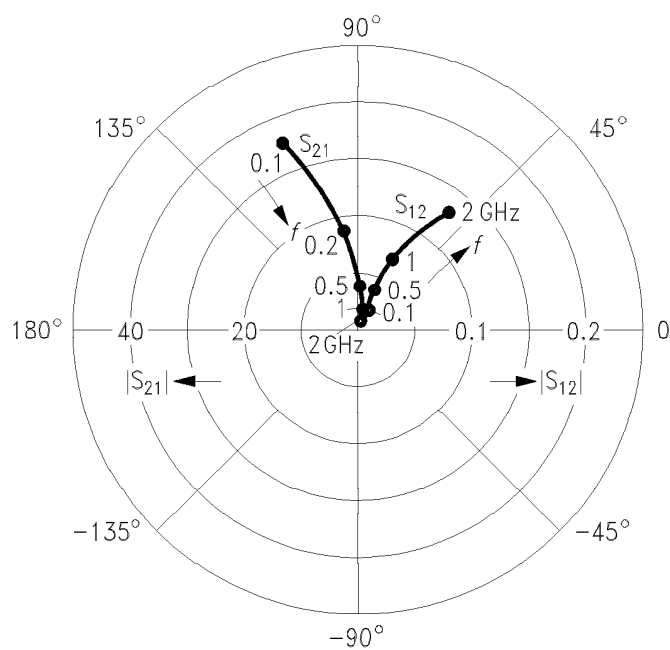

EHT08014

### Common Emitter S Parameters (continued)

$f$	$S_{11}$		$S_{21}$		$S_{12}$		$S_{22}$	
	MAG	ANG	MAG	ANG	MAG	ANG	MAG	ANG
$I_C = 70 \text{ mA}, V_{CE} = 5 \text{ V}, Z_0 = 50 \Omega$								
0.1	0.72	-149	34.51	108	0.014	42	0.37	-87
0.3	0.73	-175	11.47	89	0.025	56	0.18	-130
0.5	0.73	176	6.84	80	0.037	62	0.16	-146
0.8	0.74	168	4.24	70	0.056	63	0.16	-157
1.0	0.75	164	3.38	64	0.069	62	0.16	-163
1.2	0.75	159	2.84	59	0.081	61	0.16	-167
1.4	0.76	155	2.45	53	0.093	59	0.16	-170
1.6	0.75	151	2.15	48	0.105	57	0.16	-171
1.8	0.77	148	1.91	42	0.177	54	0.17	-173
2.0	0.78	144	1.71	38	0.127	52	0.18	-177

$S_{11}, S_{22} = f(f)$   
 $I_C = 70 \text{ mA}, V_{CE} = 5 \text{ V}, Z_0 = 50 \Omega$

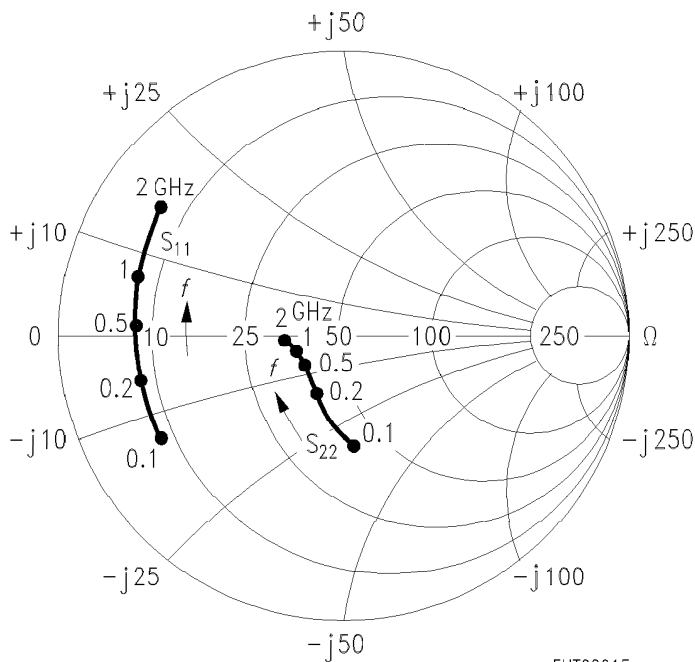

EHT08015

$S_{12}, S_{21} = f(f)$   
 $I_C = 70 \text{ mA}, V_{CE} = 5 \text{ V}, Z_0 = 50 \Omega$

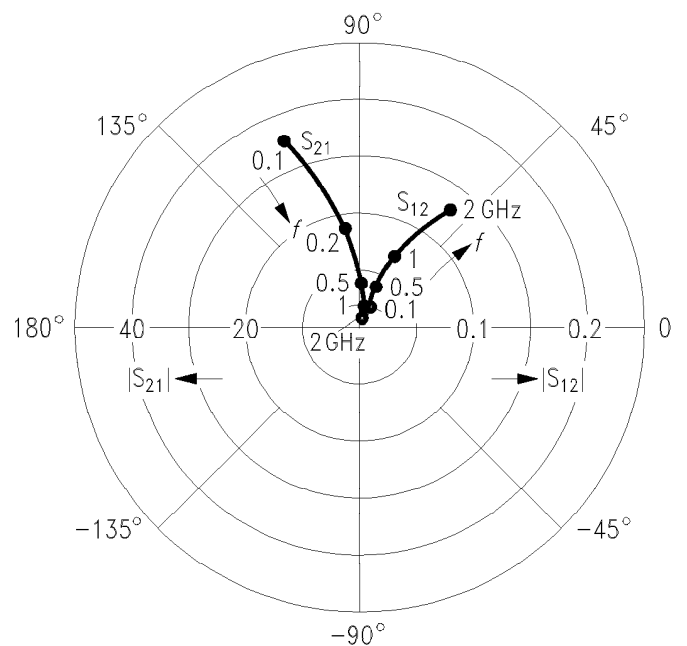

EHT08016

## Common Emitter Large Signal Parameters

### Linear output voltage $V_o = f(I_c)$

$d_{IM} = 60$  dB,  $f_1 = 806$  MHz,

$f_2 = 810$  MHz,  $Z_s = Z_L = 50 \Omega$

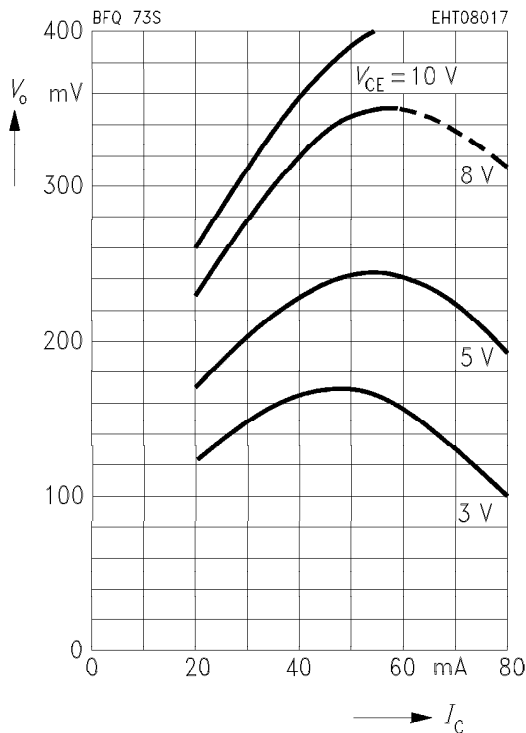

### Note:

The transistor is driven by 2 adjacent signals  $f_1, f_2$  with equal output power levels  $P_o$  for each carrier.

The distance  $d_{IM}$  between  $P_o$  and the third order intermodulation products  $P_{IM}$  ( $2f_1 - f_2$  or  $2f_2 - f_1$ ) is:

$$d_{IM} = P_o - P_{IM}$$

where  $P_o = 10 \log (V_o^2 / (50 \Omega \cdot 1 \text{mW}))$  (dBm)

and  $V_o =$  linear output voltage of each carrier.

The 3rd order intercept point  $IP_3$  will be found by extrapolation to the point where  $P_{IM}$  would be identical to  $P_o$ :

$$IP_3 (\text{output}) = P_o + d_{IM}/2.$$

Linear output voltages for other  $d_{IM}$  (e.g. 50 dB) can be calculated thereby.