

## NPN Silicon RF Transistor

- For low noise, high-gain amplifiers up to 2GHz
- For linear broadband amplifiers
- $f_T = 8\text{GHz}$   
 $F = 1.3\text{dB at } 900\text{MHz}$



**ESD: Electrostatic discharge sensitive device, observe handling precaution!**

Type	Marking	Ordering Code	Pin Configuration			Package
BFR 193	RCs	Q62702-F1218	1 = B	2 = E	3 = C	SOT-23

### Maximum Ratings

Parameter	Symbol	Values	Unit
Collector-emitter voltage	$V_{CEO}$	12	V
Collector-emitter voltage	$V_{CES}$	20	
Collector-base voltage	$V_{CBO}$	20	
Emitter-base voltage	$V_{EBO}$	2	
Collector current	$I_C$	80	mA
Base current	$I_B$	10	
Total power dissipation $T_S \leq 69\text{ }^\circ\text{C}$	$P_{tot}$	580	mW
Junction temperature	$T_j$	150	$^\circ\text{C}$
Ambient temperature	$T_A$	- 65 ... + 150	
Storage temperature	$T_{stg}$	- 65 ... + 150	

### Thermal Resistance

Junction - soldering point <sup>1)</sup>	$R_{thJS}$	$\leq 140$	K/W
--	------------	------------	-----

1)  $T_S$  is measured on the collector lead at the soldering point to the pcb.

**Electrical Characteristics** at  $T_A = 25^\circ\text{C}$ , unless otherwise specified.

Parameter	Symbol	Values			Unit
		min.	typ.	max.	
<b>DC Characteristics</b>					
Collector-emitter breakdown voltage $I_C = 1 \text{ mA}, I_B = 0$	$V_{(BR)CEO}$	12	-	-	V
Collector-emitter cutoff current $V_{CE} = 20 \text{ V}, V_{BE} = 0$	$I_{CES}$	-	-	100	$\mu\text{A}$
Collector-base cutoff current $V_{CB} = 10 \text{ V}, I_E = 0$	$I_{CBO}$	-	-	100	nA
Emitter-base cutoff current $V_{EB} = 1 \text{ V}, I_C = 0$	$I_{EBO}$	-	-	1	$\mu\text{A}$
DC current gain $I_C = 30 \text{ mA}, V_{CE} = 8 \text{ V}$	$h_{FE}$	50	100	200	-

**Electrical Characteristics** at  $T_A = 25^\circ\text{C}$ , unless otherwise specified.

Parameter	Symbol	Values			Unit
		min.	typ.	max.	
<b>AC Characteristics</b>					
Transition frequency $I_C = 50 \text{ mA}$ , $V_{CE} = 8 \text{ V}$ , $f = 500 \text{ MHz}$	$f_T$	6	8	-	GHz
Collector-base capacitance $V_{CB} = 10 \text{ V}$ , $f = 1 \text{ MHz}$	$C_{cb}$	-	0.68	1	pF
Collector-emitter capacitance $V_{CE} = 10 \text{ V}$ , $f = 1 \text{ MHz}$	$C_{ce}$	-	0.24	-	
Emitter-base capacitance $V_{EB} = 0.5 \text{ V}$ , $f = 1 \text{ MHz}$	$C_{eb}$	-	1.8	-	
Noise figure $I_C = 10 \text{ mA}$ , $V_{CE} = 8 \text{ V}$ , $Z_S = Z_{\text{Sopt}}$ $f = 900 \text{ MHz}$ $f = 1.8 \text{ GHz}$	$F$	-	1.3 2.1	-	dB
Power gain <sup>2)</sup> $I_C = 30 \text{ mA}$ , $V_{CE} = 8 \text{ V}$ , $Z_S = Z_{\text{Sopt}}$ $Z_L = Z_{\text{Lopt}}$ $f = 900 \text{ MHz}$ $f = 1.8 \text{ GHz}$	$G_{\text{ma}}$	-	14.5 9	-	
Transducer gain $I_C = 30 \text{ mA}$ , $V_{CE} = 8 \text{ V}$ , $Z_S = Z_L = 50 \Omega$ $f = 900 \text{ MHz}$ $f = 1.8 \text{ GHz}$	$ S_{21e} ^2$	-	12.5 7	-	

2)  $G_{\text{ma}} = |S_{21}/S_{12}| (k - (k^2 - 1)^{1/2})$

## SPICE Parameters (Gummel-Poon Model, Berkeley-SPICE 2G.6 Syntax) :

### Transistor Chip Data

IS =	0.2738	fA	BF =	125	-	NF =	0.95341	-
VAF =	24	V	IKF =	0.26949	A	ISE =	10.627	fA
NE =	1.935	-	BR =	14.267	-	NR =	1.4289	-
VAR =	3.8742	V	IKR =	0.037925	A	ISC =	0.037409	fA
NC =	0.94371	-	RB =	1	$\Omega$	IRB =	0.91763	mA
RBM =	1.8368	$\Omega$	RE =	0.76534	$\Omega$	RC =	0.11938	$\Omega$
CJE =	1.1824	fF	VJE =	0.70276	V	MJE =	0.48654	-
TF =	18.828	ps	XTF =	0.69477	-	VTF =	0.8	V
ITF =	0.96893	mA	PTF =	0	deg	CJC =	935.03	fF
VJC =	1.1828	V	MJC =	0.30002	-	XCJC =	0.053563	-
TR =	1.0037	ns	CJS =	0	fF	VJS =	0.75	V
MJS =	0	-	XTB =	0	-	EG =	1.11	eV
XTI =	3	-	FC =	0.72063	-	TNOM	300	K

All parameters are ready to use, no scaling is necessary.

Extracted on behalf of SIEMENS Small Signal Semiconductors by:  
 Institut für Mobil-und Satellitenfunktechnik (IMST)

© 1996 SIEMENS AG

### Package Equivalent Circuit:

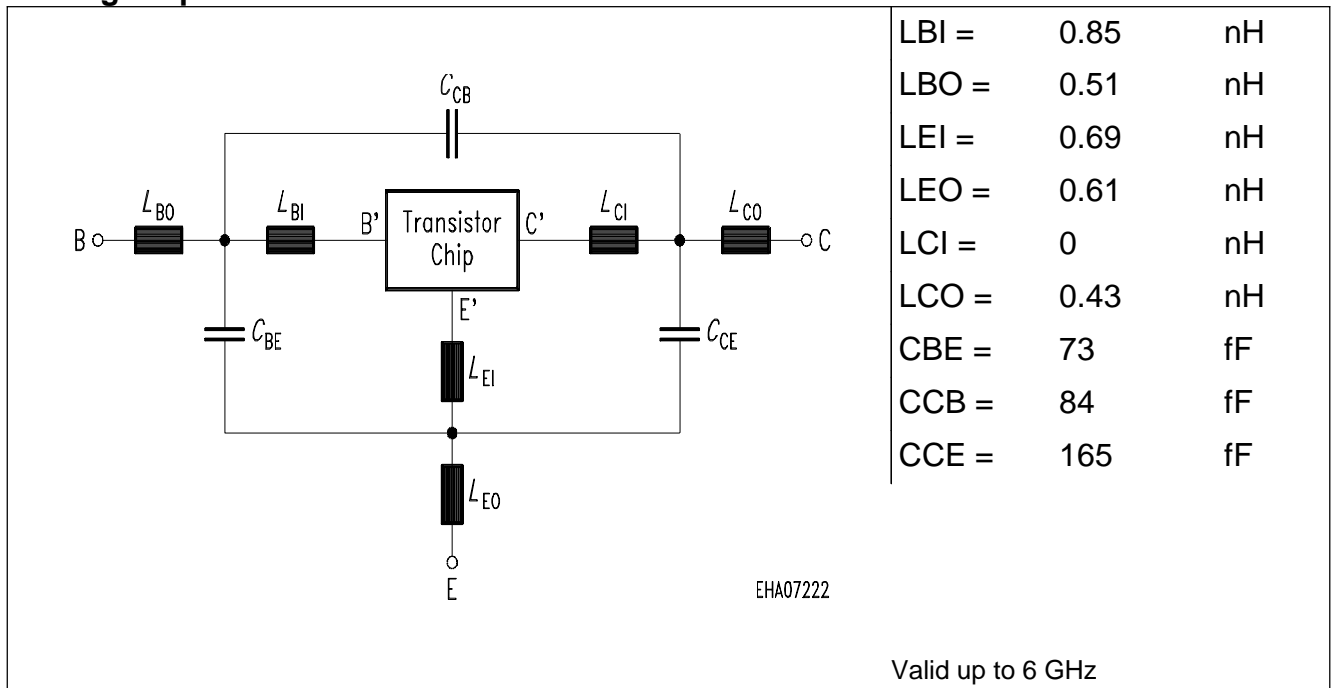

For examples and ready to use parameters please contact your local Siemens distributor or sales office to obtain a Siemens CD-ROM or see Internet: <http://www.siemens.de/Semiconductor/products/35/35.htm>

### Total power dissipation $P_{tot} = f(T_A^*, T_S)$

\* Package mounted on epoxy

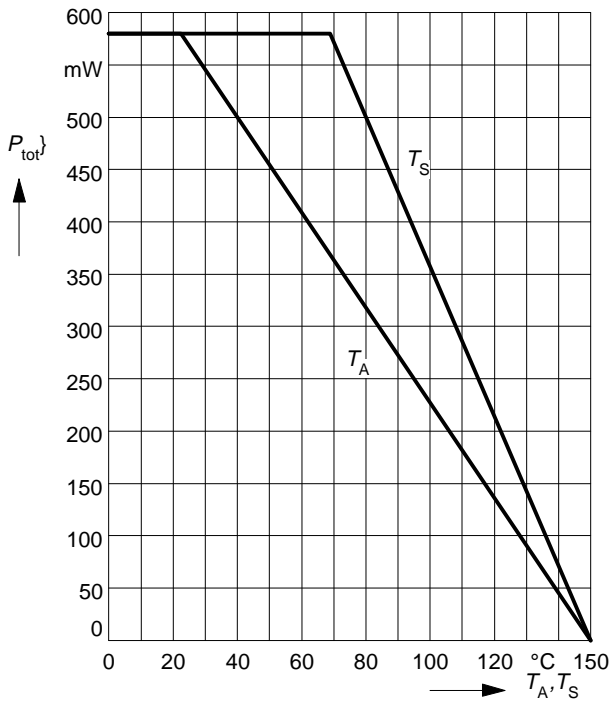

### Permissible Pulse Load $R_{thJS} = f(t_p)$

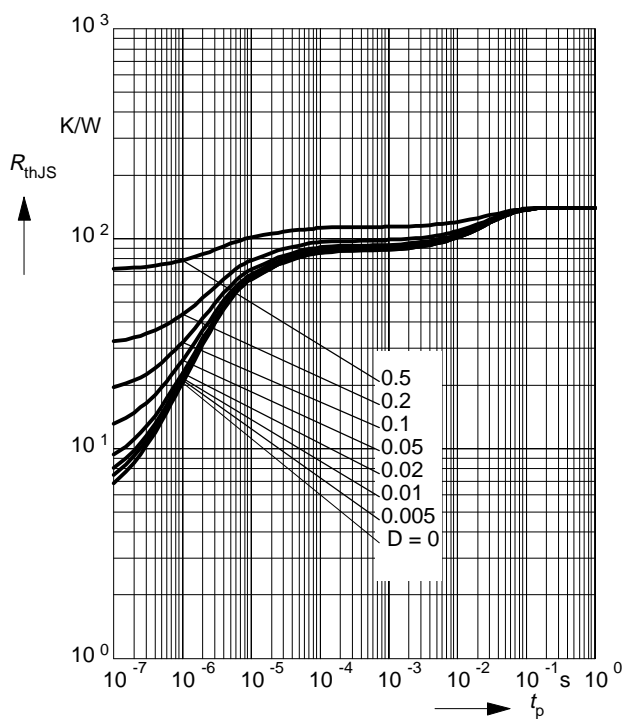

### Permissible Pulse Load $P_{totmax}/P_{totDC} = f(t_p)$

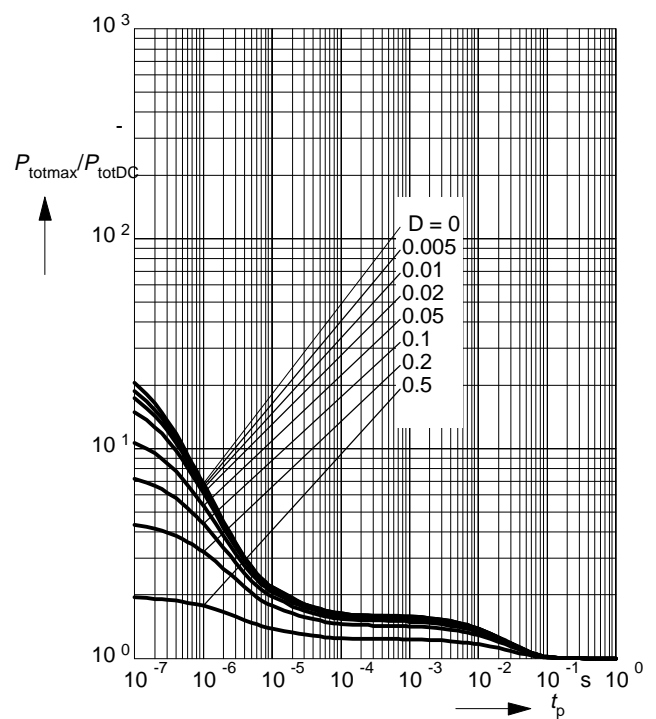

### Collector-base capacitance $C_{cb} = f(V_{CB})$

$V_{BE} = v_{be} = 0, f = 1\text{MHz}$

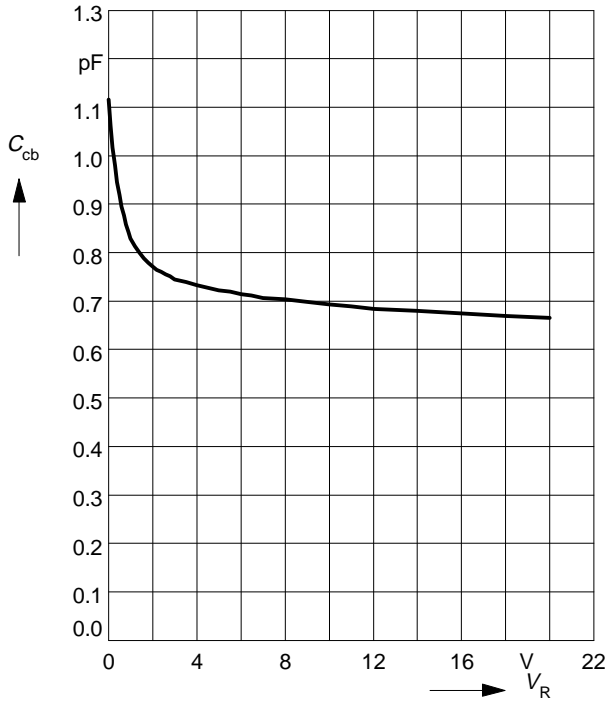

### Transition frequency $f_T = f(I_C)$

$V_{CE} = \text{Parameter}$

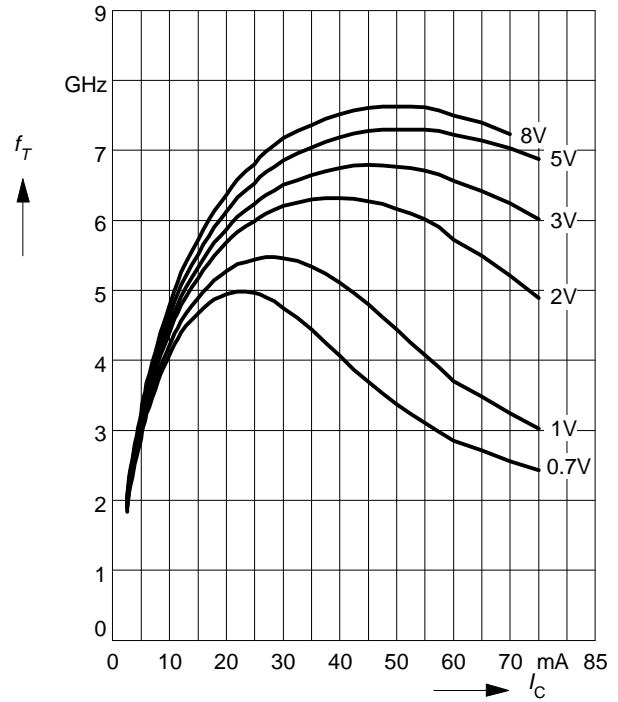

### Power Gain $G_{ma}, G_{ms} = f(I_C)$

$f = 0.9\text{GHz}$

$V_{CE} = \text{Parameter}$

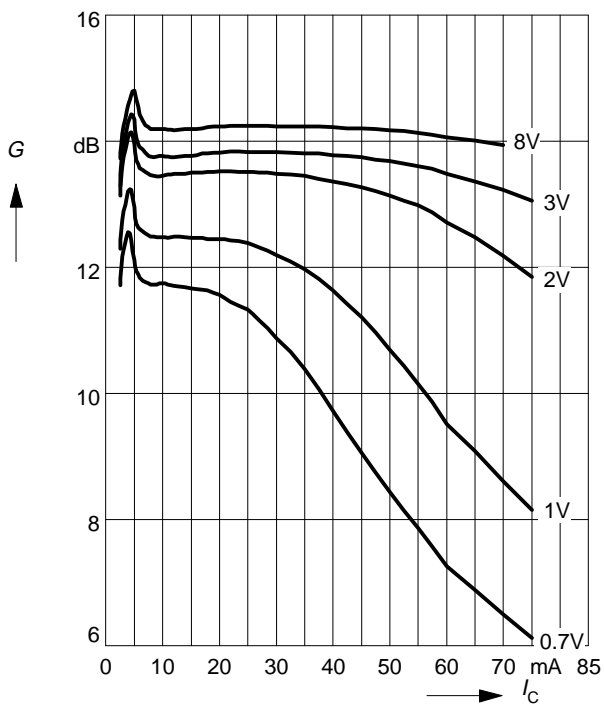

### Power Gain $G_{ma}, G_{ms} = f(I_C)$

$f = 1.8\text{GHz}$

$V_{CE} = \text{Parameter}$

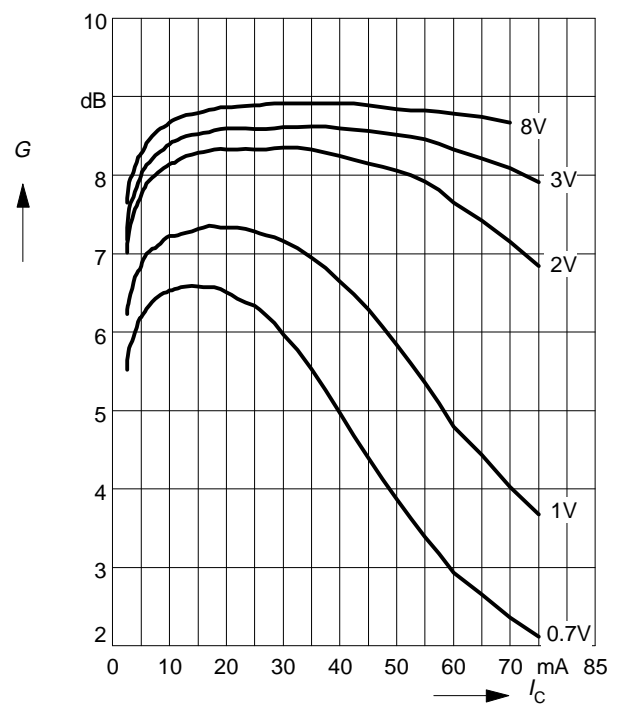

**Power Gain**  $G_{ma}, G_{ms} = f(V_{CE})$ : \_\_\_\_\_  
 $|S_{21}|^2 = f(V_{CE})$ : - - - - -

$f =$  Parameter

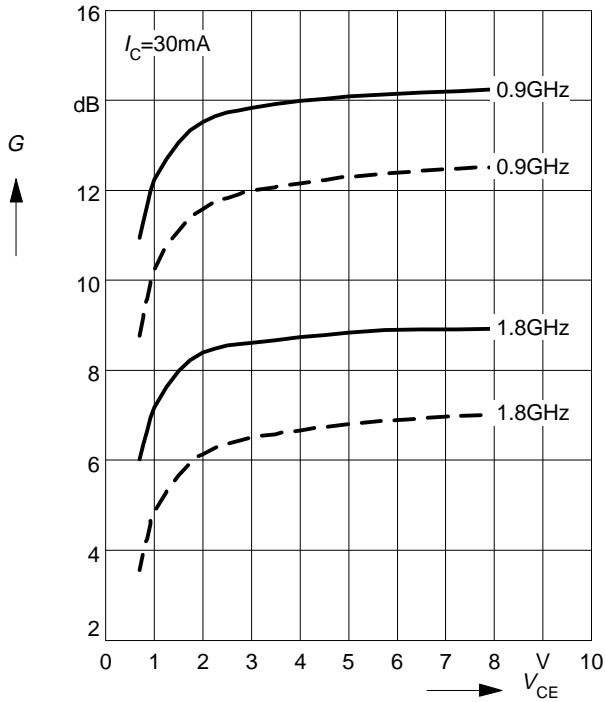

**Intermodulation Intercept Point**  $IP_3 = f(I_C)$   
 (3rd order, Output,  $Z_S = Z_L = 50\Omega$ )

$V_{CE} =$  Parameter,  $f = 900\text{MHz}$

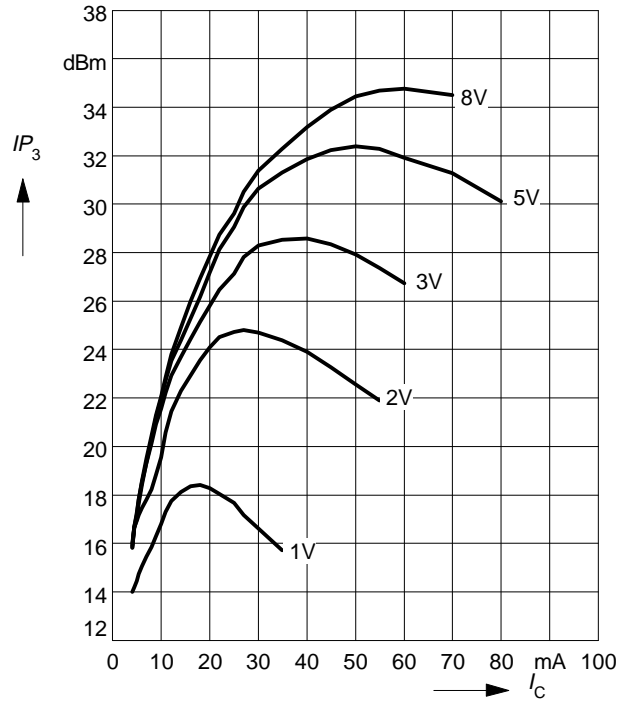

**Power Gain**  $G_{ma}, G_{ms} = f(f)$

$V_{CE} =$  Parameter

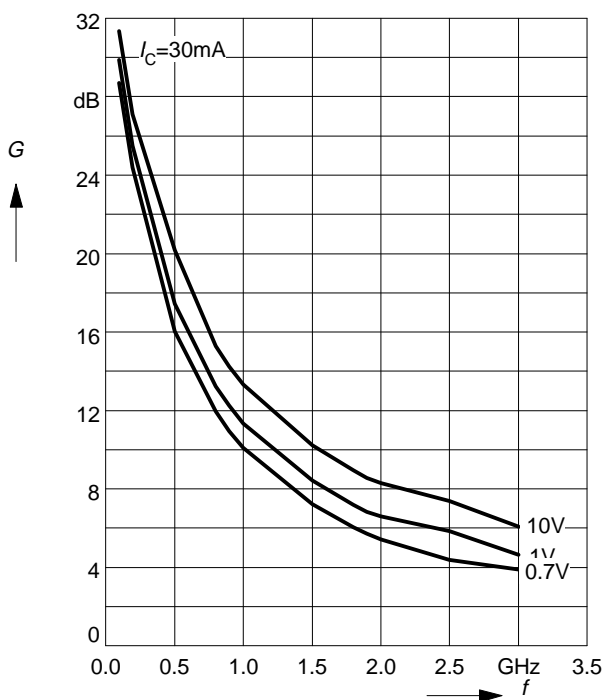

**Power Gain**  $|S_{21}|^2 = f(f)$

$V_{CE} =$  Parameter

