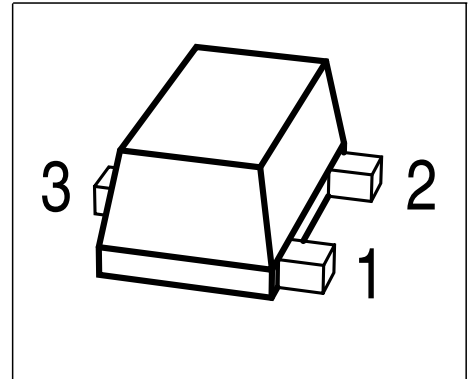

**NPN Silicon RF Transistor**

Preliminary data

- High current capability and low figure for wide dynamic range application
- Low voltage operation
- Ideal for low phase noise oscillators up to 3.5 GHz
- Low noise figure: 1.1 dB at 1.8 GHz

**ESD: Electrostatic discharge sensitive device, observe handling precaution!**

Type	Marking	Pin Configuration			Package
BFR380F	FCs	1 = B	2 = E	3 = C	TSFP-3

**Maximum Ratings**

Parameter	Symbol	Value	Unit
Collector-emitter voltage	$V_{CEO}$	6	V
Collector-emitter voltage	$V_{CES}$	15	
Collector-base voltage	$V_{CBO}$	15	
Emitter-base voltage	$V_{EBO}$	2	
Collector current	$I_C$	80	mA
Base current	$I_B$	14	
Total power dissipation <sup>1)</sup> $T_S \leq 95^\circ\text{C}$	$P_{tot}$	380	mW
Junction temperature	$T_j$	150	°C
Ambient temperature	$T_A$	-65 ... 150	
Storage temperature	$T_{stg}$	-65 ... 150	

**Thermal Resistance**

Parameter	Symbol	Value	Unit
Junction - soldering point <sup>2)</sup>	$R_{thJS}$	$\leq 145$	K/W

<sup>1)</sup> $T_S$  is measured on the collector lead at the soldering point to the pcb

<sup>2)</sup>For calculation of  $R_{thJA}$  please refer to Application Note Thermal Resistance

**Electrical Characteristics** at  $T_A = 25^\circ\text{C}$ , unless otherwise specified

Parameter	Symbol	Values			Unit
		min.	typ.	max.	
<b>Characteristics</b>					
Collector-emitter breakdown voltage $I_C = 1 \text{ mA}, I_B = 0$	$V_{(BR)CEO}$	6	9	-	V
Collector-base cutoff current $V_{CB} = 5 \text{ V}, I_E = 0$	$I_{CBO}$	-	-	100	nA
Emitter-base cutoff current $V_{EB} = 1 \text{ V}, I_C = 0$	$I_{EBO}$	-	-	1	$\mu\text{A}$
DC current gain- $I_C = 40 \text{ mA}, V_{CE} = 3 \text{ V}$	$h_{FE}$	60	100	200	-

**Electrical Characteristics** at  $T_A = 25^\circ\text{C}$ , unless otherwise specified

Parameter	Symbol	Values			Unit
		min.	typ.	max.	
<b>AC Characteristics</b> (verified by random sampling)					
Transition frequency $I_C = 40\text{ mA}$ , $V_{CE} = 3\text{ V}$ , $f = 1\text{ GHz}$	$f_T$	11	14	-	GHz
Collector-base capacitance $V_{CB} = 5\text{ V}$ , $f = 1\text{ MHz}$ , emitter grounded	$C_{cb}$	-	0.47	0.7	pF
Collector emitter capacitance $V_{CE} = 5\text{ V}$ , $f = 1\text{ MHz}$ , base grounded	$C_{ce}$	-	0.2	-	
Emitter-base capacitance $V_{EB} = 0.5\text{ V}$ , $f = 1\text{ MHz}$ , collector grounded	$C_{eb}$	-	1	-	
Noise figure $I_C = 8\text{ mA}$ , $V_{CE} = 3\text{ V}$ , $Z_S = Z_{Sopt}$ , $f = 1.8\text{ GHz}$	$F_{min}$	-	1.1	-	dB
Power gain, maximum available <sup>1)</sup> $I_C = 40\text{ mA}$ , $V_{CE} = 3\text{ V}$ , $Z_S = Z_{Sopt}$ , $Z_L = Z_{Lopt}$ , $f = 1.8\text{ GHz}$	$G_{ma}$	-	13.5	-	
$I_C = 40\text{ mA}$ , $V_{CE} = 3\text{ V}$ , $Z_S = Z_{Sopt}$ , $Z_L = Z_{Lopt}$ , $f = 3\text{ GHz}$		-	9	-	
Insertion power gain $V_{CE} = 3\text{ V}$ , $I_C = 40\text{ mA}$ , $f = 1.8\text{ GHz}$ , $Z_S = Z_L = 50\Omega$	$ S_{21} ^2$	-	11	-	dB
$V_{CE} = 3\text{ V}$ , $I_C = 40\text{ mA}$ , $f = 3\text{ GHz}$ , $Z_S = Z_L = 50\Omega$		-	6.5	-	
Third order intercept point at output <sup>2)</sup> $V_{CE} = 3\text{ V}$ , $I_C = 40\text{ mA}$ , $f = 1.8\text{ GHz}$ , $Z_S = Z_L = 50\Omega$	$IP_3$	-	29	-	dBm
1dB Compression point at output <sup>3)</sup> $I_C = 40\text{ mA}$ , $V_{CE} = 3\text{ V}$ , $Z_S = Z_L = 50\Omega$ , $f = 1.8\text{ GHz}$	$P_{-1dB}$	-	16	-	

$$^1G_{ma} = |S_{21} / S_{12}| (k - (k^2 - 1)^{1/2})$$

<sup>2</sup>IP3 value depends on termination of all intermodulation frequency components.  
Termination used for this measurement is 50Ω from 0.1 MHz to 6 GHz

<sup>3</sup>DC current at no input power

**SPICE Parameter (Gummel-Poon Model, Berkley-SPICE 2G.6 Syntax):**

**Transistor Chip Data:**

IS =	9.965	fA	BF =	116.376	-	NF =	1.107	-
VAF =	27.69	V	IKF =	736	mA	ISE =	0.2676	fA
NE =	1.64	-	BR =	22.802	-	NR =	1.056	-
VAR =	30	V	IKR =	0.011	A	ISC =	6.9739	pA
NC =	1.678	-	RB =	9.71	$\Omega$	IRB =	0.2564	mA
RBM =	1.322	$\Omega$	RE =	221	m $\Omega$	RC =	0.101	$\Omega$
CJE =	116.7	fF	VJE =	0.782	V	MJE =	0.5	-
TF =	8.789	ps	XTF =	0.496	-	VTF =	0.338	V
ITF =	1.529	mA	PTF =	0	deg	CJC =	840	fF
VJC =	6.949	V	MJC =	0.472	-	XCJC =	0.202	-
TR =	6.949	ns	CJS =	0	fF	VJS =	0.75	V
MJS =	0	-	NK =	0.5	-	EG =	1.11	eV
XTI =	0	-	FC =	0.975	-	TNOM	300	K

All parameters are ready to use, no scaling is necessary. Extracted on behalf of Infineon Technologies AG by: Institut für Mobil- und Satellitentechnik (IMST)

**Package Equivalent Circuit:**

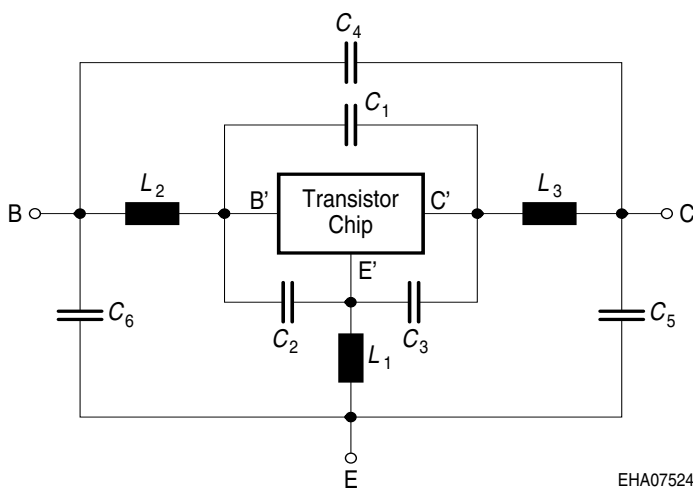

$L_1 =$	0.556	nH
$L_2 =$	0.675	nH
$L_3 =$	0.381	nH
$C_1 =$	43	fF
$C_2 =$	123	fF
$C_3 =$	66	fF
$C_4 =$	10	fF
$C_5 =$	36	fF
$C_6 =$	47	fF

Valid up to 6GHz

For examples and ready to use parameters please contact your local Infineon Technologies distributor or sales office to obtain a Infineon Technologies CD-ROM or see Internet: <http://www.infineon.com/silicondiscretres>

**Total power dissipation  $P_{tot} = f(T_S)$**

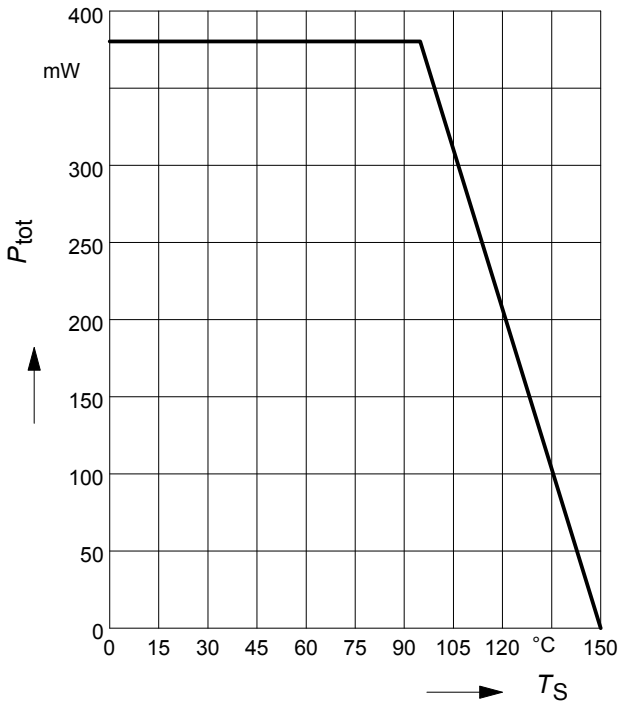

**Permissible Pulse Load  $R_{thJS} = f(t_p)$**

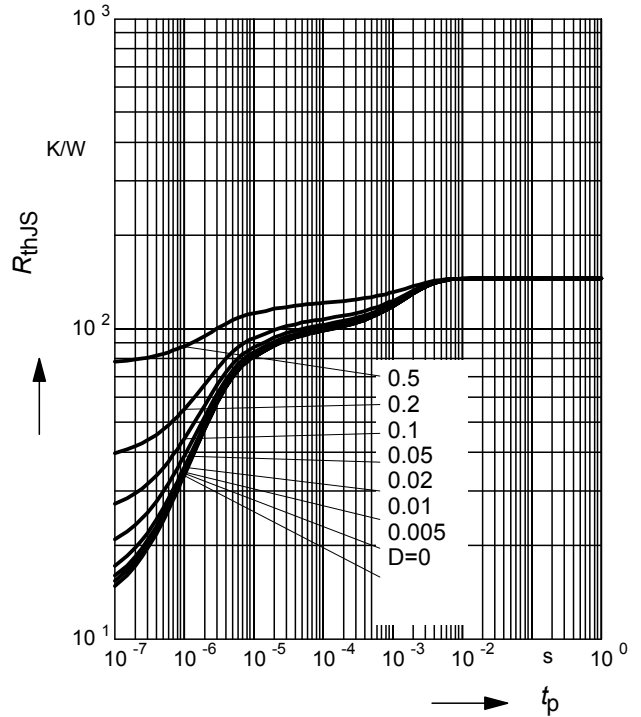

**Permissible Pulse Load**

$P_{totmax}/P_{totDC} = f(t_p)$

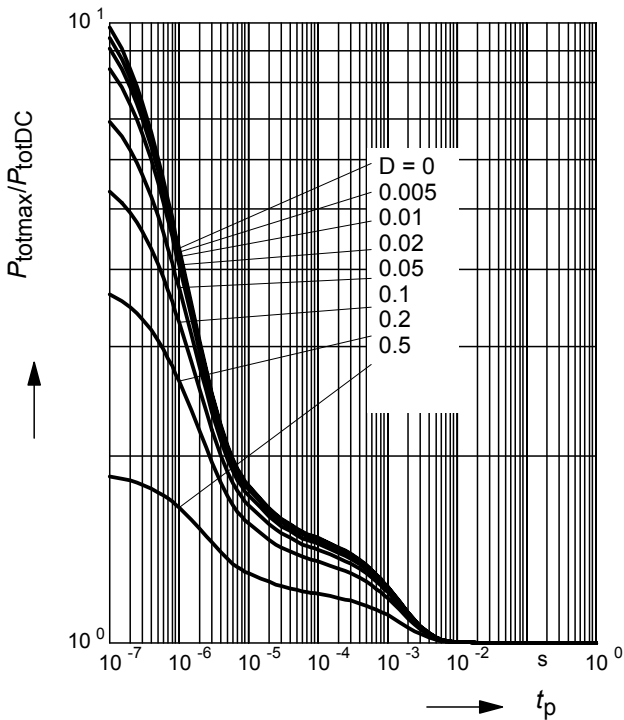

**Collector-base capacitance  $C_{cb} = f(V_{CB})$**

$f = 1\text{MHz}$

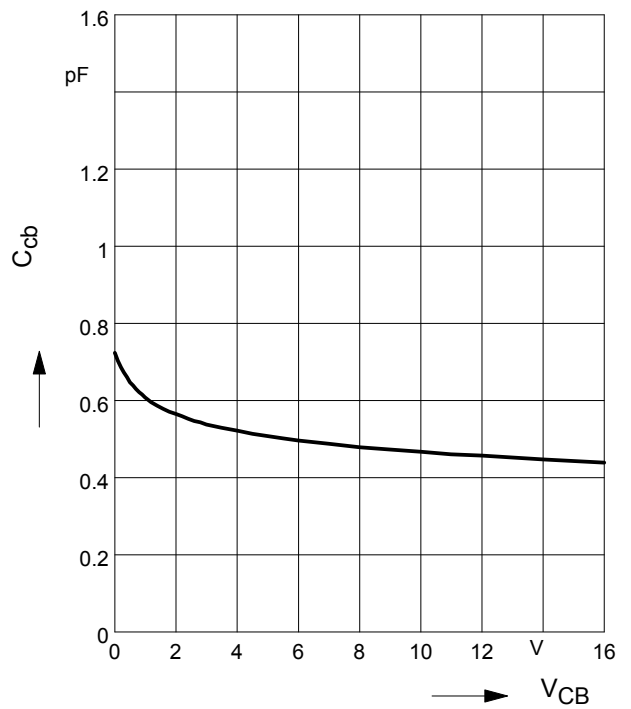

**Third order Intercept Point  $IP_3 = f(I_C)$**

(Output,  $Z_S = Z_L = 50\Omega$ )

$V_{CE} = \text{parameter}$ ,  $f = 1.8\text{GHz}$

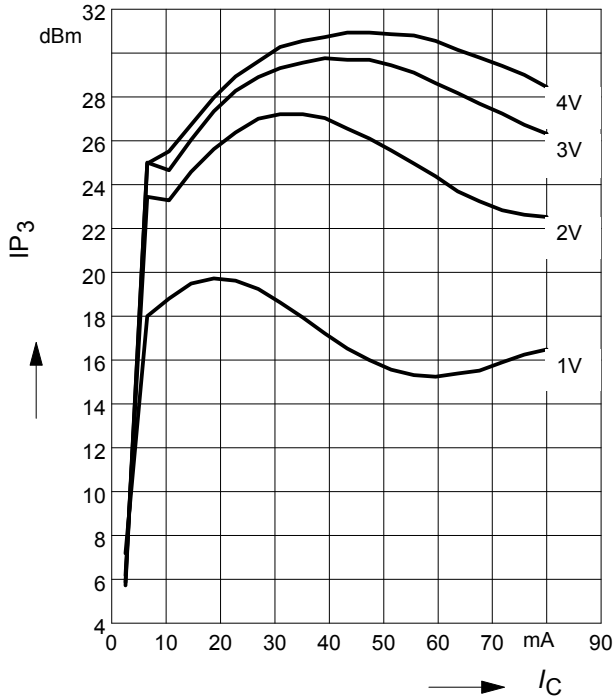

**Transition frequency  $f_T = f(I_C)$**

$f = 1\text{GHz}$

$V_{CE} = \text{parameter}$

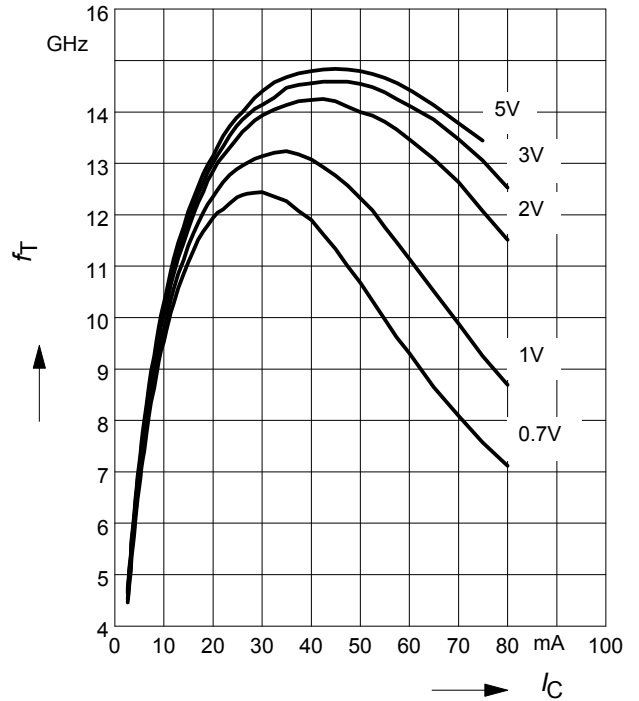

**Power gain  $G_{ma}, G_{ms} = f(I_C)$**

$f = 0.9\text{GHz}$

$V_{CE} = \text{parameter}$

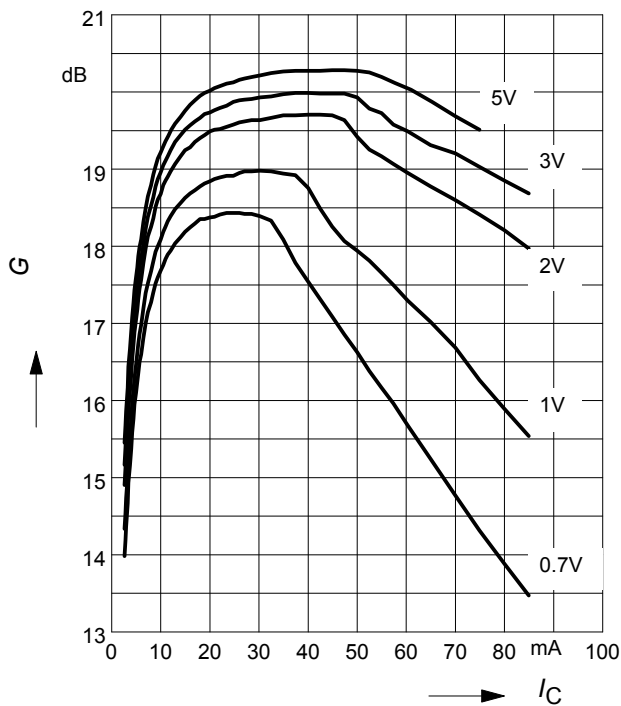

**Power gain  $G_{ma}, G_{ms} = f(I_C)$**

$f = 1.8\text{GHz}$

$V_{CE} = \text{parameter}$

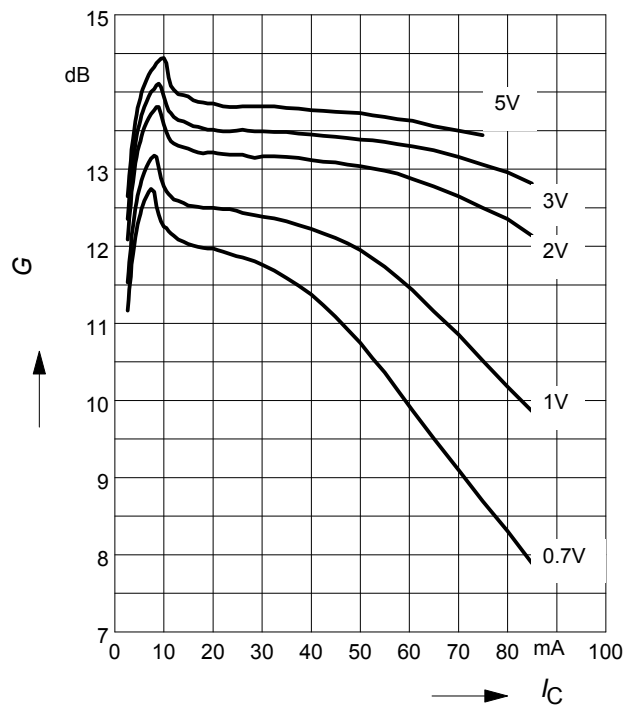

**Power Gain  $G_{ma}$ ,  $G_{ms} = f(f)$**

$V_{CE} = \text{parameter}$

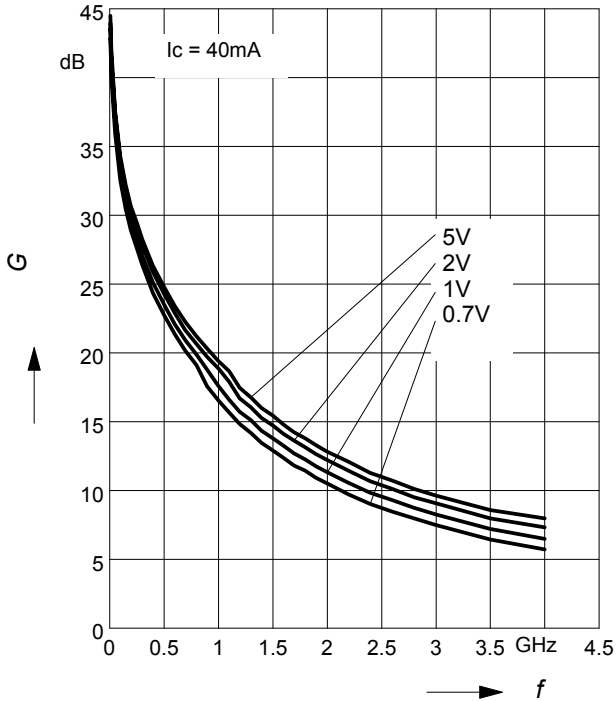

**Power Gain  $|S_{21}|^2 = f(f)$**

$V_{CE} = \text{parameter}$

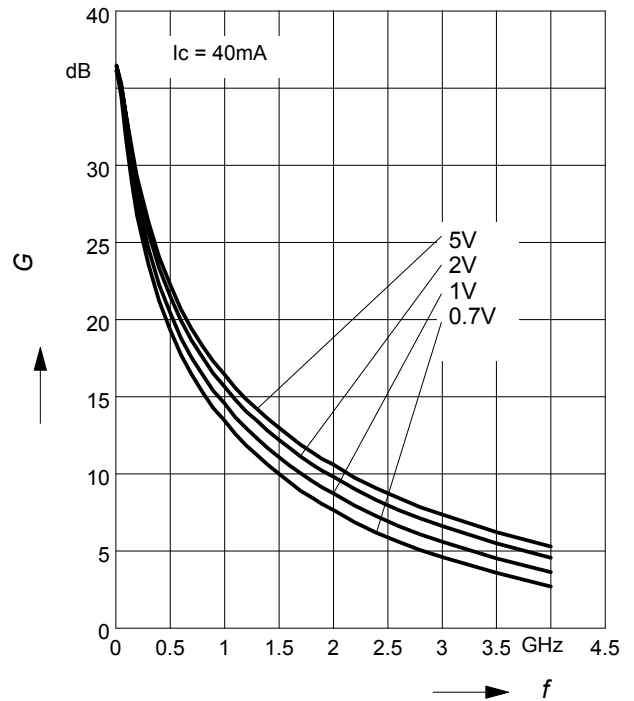

**Power Gain  $G_{ma}$ ,  $G_{ms} = f(V_{CE})$ : —**

$|S_{21}|^2 = f(V_{CE})$ : - - - -

$f = \text{parameter}$

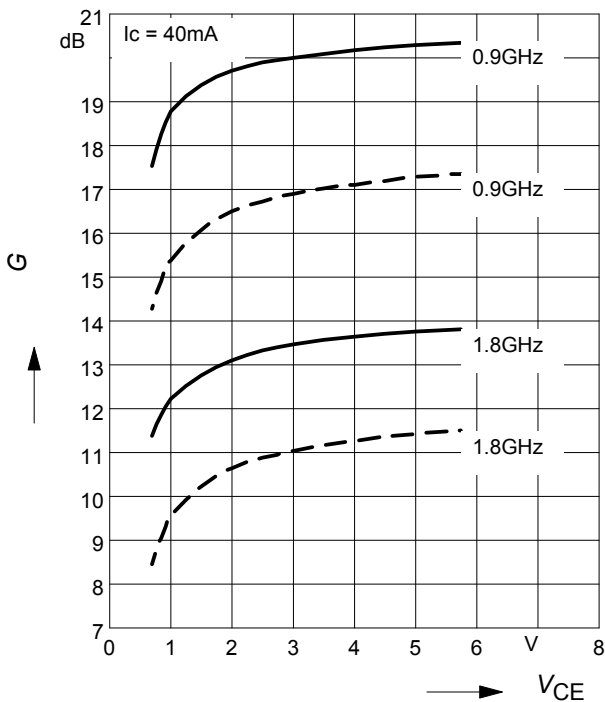

**Power gain  $G_{ma}$ ,  $G_{ms} = f(I_C)$**

$V_{CE} = 2V$

$f = \text{parameter}$

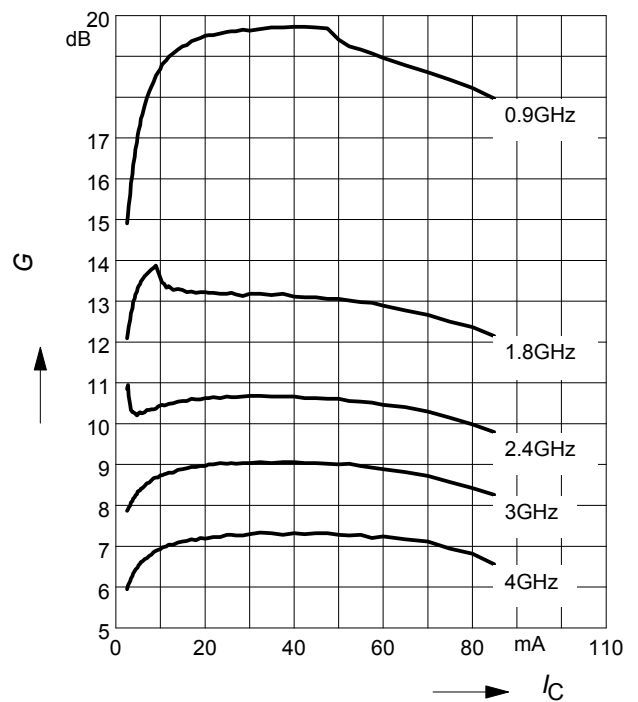

**Noise figure  $NF = f(I_C)$**

$V_{CE} = 3V, f = 1,8 \text{ GHz}$

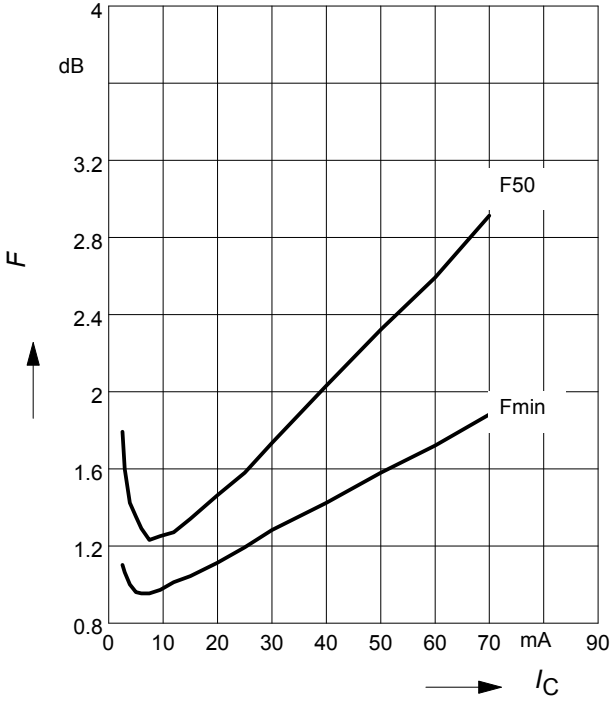

**Source impedance for min.**

**noise figure vs. frequency**

$V_{CE} = 3 \text{ V}$

