

NPN Silicon RF Transistor

- For low noise, high-gain broadband amplifiers at collector current from 2mA to 30mA
- CECC.type available: CECC 50 002/256



ESD: Electrostatic discharge sensitive device, observe handling precaution!

Type	Marking	Ordering Code	Pin Configuration			Package
BFR 93A	R2s	Q62702-F1086	1 = B	2 = E	3 = C	SOT-23

Maximum Ratings

Parameter	Symbol	Values	Unit
Collector-emitter voltage	V_{CEO}	12	V
Collector-emitter voltage	V_{CES}	20	
Collector-base voltage	V_{CBO}	20	
Emitter-base voltage	V_{EBO}	2	
Collector current	I_C	50	mA
Base current	I_B	6	
Total power dissipation $T_S \leq 63 \text{ }^\circ\text{C}$	P_{tot}	300	mW
Junction temperature	T_j	150	$^\circ\text{C}$
Ambient temperature	T_A	- 65 ... + 150	
Storage temperature	T_{stg}	- 65 ... + 150	

Thermal Resistance

Junction - soldering point ¹⁾	R_{thJS}	≤ 290	K/W
--	------------	------------	-----

1) T_S is measured on the collector lead at the soldering point to the pcb.

Electrical Characteristics at $T_A = 25^\circ\text{C}$, unless otherwise specified.

Parameter	Symbol	Values			Unit
		min.	typ.	max.	
DC Characteristics					
Collector-emitter breakdown voltage $I_C = 1 \text{ mA}, I_B = 0$	$V_{(BR)CEO}$	12	-	-	V
Collector-emitter cutoff current $V_{CE} = 20 \text{ V}, V_{BE} = 0$	I_{CES}	-	-	100	μA
Collector-base cutoff current $V_{CB} = 10 \text{ V}, I_E = 0$	I_{CBO}	-	-	100	nA
Emitter-base cutoff current $V_{EB} = 2 \text{ V}, I_C = 0$	I_{EBO}	-	-	10	μA
DC current gain $I_C = 30 \text{ mA}, V_{CE} = 8 \text{ V}$	h_{FE}	50	100	200	-

Electrical Characteristics at $T_A = 25^\circ\text{C}$, unless otherwise specified.

Parameter	Symbol	Values			Unit
		min.	typ.	max.	
AC Characteristics					
Transition frequency $I_C = 30\text{ mA}$, $V_{CE} = 8\text{ V}$, $f = 500\text{ MHz}$	f_T	4.5	6	-	GHz
Collector-base capacitance $V_{CB} = 10\text{ V}$, $f = 1\text{ MHz}$	C_{cb}	-	0.58	0.9	pF
Collector-emitter capacitance $V_{CE} = 10\text{ V}$, $f = 1\text{ MHz}$	C_{ce}	-	0.23	-	
Emitter-base capacitance $V_{EB} = 0.5\text{ V}$, $f = 1\text{ MHz}$	C_{eb}	-	1.7	-	
Noise figure $I_C = 5\text{ mA}$, $V_{CE} = 8\text{ V}$, $Z_S = Z_{Sopt}$ $f = 900\text{ MHz}$ $f = 1.8\text{ GHz}$	F	-	2 3.3	-	dB
Power gain ²⁾ $I_C = 30\text{ mA}$, $V_{CE} = 8\text{ V}$, $Z_S = Z_{Sopt}$ $Z_L = Z_{Lopt}$ $f = 900\text{ MHz}$ $f = 1.8\text{ GHz}$	G_{ma}	-	13.5 8.5	-	
Transducer gain $I_C = 30\text{ mA}$, $V_{CE} = 8\text{ V}$, $Z_S = Z_L = 50\ \Omega$ $f = 900\text{ MHz}$ $f = 1.8\text{ GHz}$	$ S_{21e} ^2$	-	12 6.5	-	

2) $G_{ma} = |S_{21}/S_{12}| (k - (k^2 - 1)^{1/2})$

SPICE Parameters (Gummel-Poon Model, Berkeley-SPICE 2G.6 Syntax) :

Transistor Chip Data

IS =	8.6752	fA	BF =	137.63	-	NF =	0.93633	-
VAF =	20.011	V	IKF =	0.33395	A	ISE =	2619.3	fA
NE =	1.5466	-	BR =	59	-	NR =	0.88761	-
VAR =	26.834	V	IKR =	0.015129	A	ISC =	0.70823	fA
NC =	1.95	-	RB =	7.2326	Ω	IRB =	0.043806	mA
RBM =	3.4649	Ω	RE =	1.0075	Ω	RC =	0.13193	Ω
CJE =	3.1538	fF	VJE =	0.70393	V	MJE =	0.5071	-
TF =	33.388	ps	XTF =	0.28319	-	VTF =	0.17765	V
ITF =	2.5184	mA	PTF =	0	deg	CJC =	1039.5	fF
VJC =	0.72744	V	MJC =	0.34565	-	XCJC =	0.21422	-
TR =	1.1061	ns	CJS =	0	fF	VJS =	0.75	V
MJS =	0	-	XTB =	0	-	EG =	1.11	eV
XTI =	3	-	FC =	0.75935	-	TNOM	300	K

All parameters are ready to use, no scaling is necessary.

Extracted on behalf of SIEMENS Small Signal Semiconductors by:
Institut für Mobil-und Satellitenfunktechnik (IMST)

© 1996 SIEMENS AG

Package Equivalent Circuit:

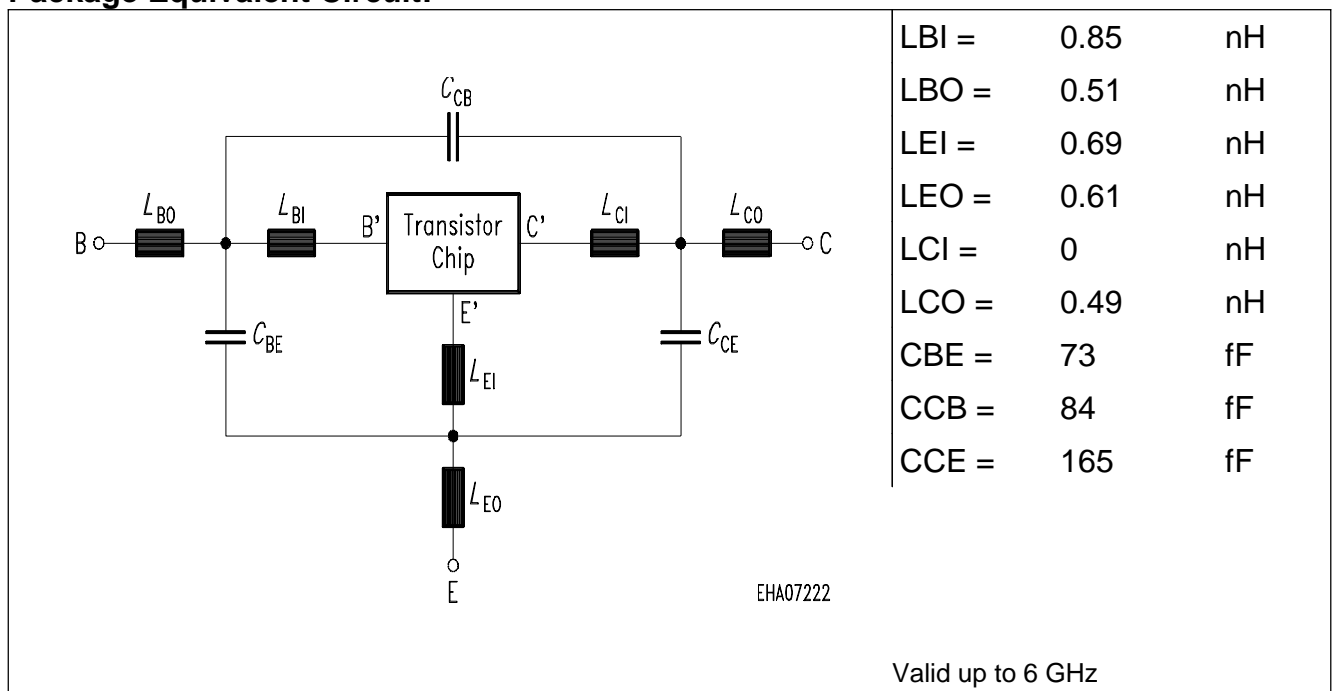

For examples and ready to use parameters please contact your local Siemens distributor or sales office to obtain a Siemens CD-ROM or see Internet: <http://www.siemens.de/Semiconductor/products/35/35.htm>

Total power dissipation $P_{tot} = f(T_A^*, T_S)$

* Package mounted on epoxy

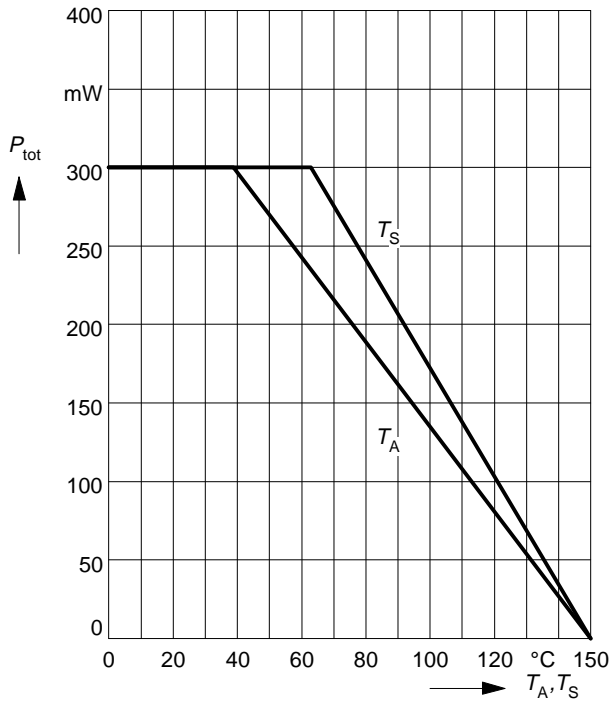

Permissible Pulse Load $R_{thJS} = f(t_p)$

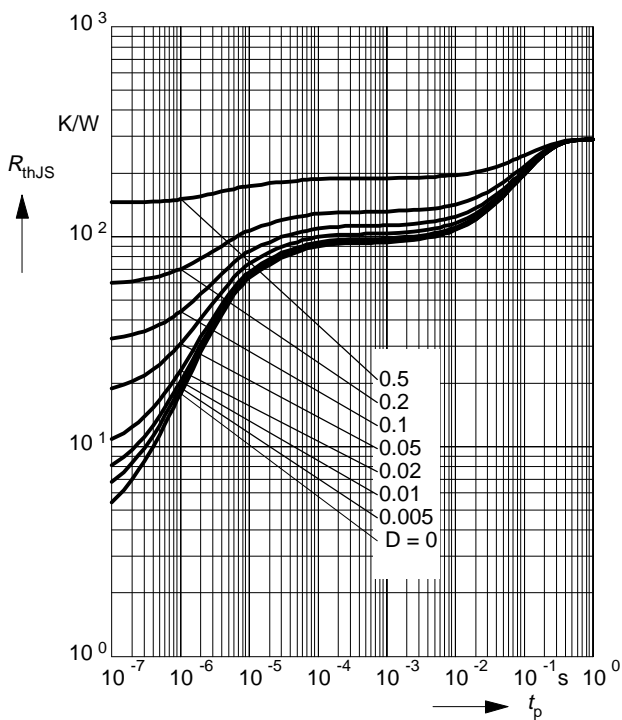

Permissible Pulse Load $P_{totmax}/P_{totDC} = f(t_p)$

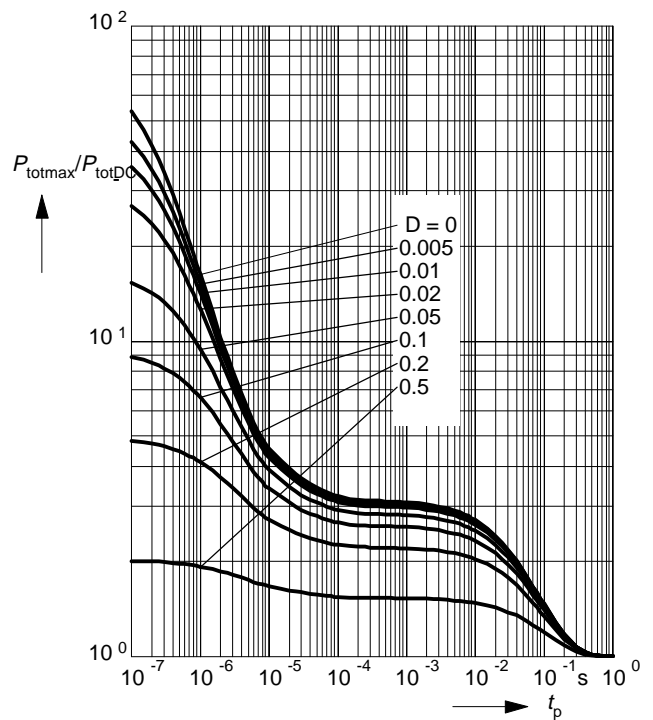

Collector-base capacitance $C_{cb} = f(V_{CB})$

$V_{BE} = v_{be} = 0, f = 1\text{MHz}$

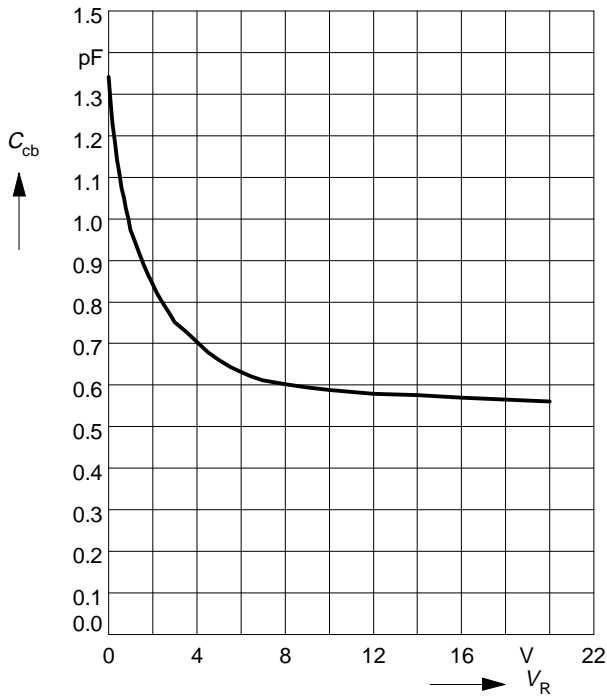

Transition frequency $f_T = f(I_C)$

$V_{CE} = \text{Parameter}$

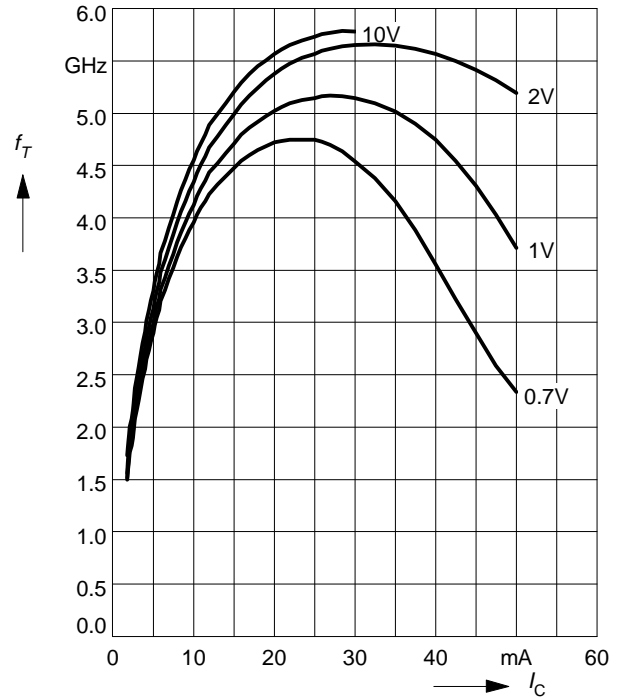

Power Gain $G_{ma}, G_{ms} = f(I_C)$

$f = 0.9\text{GHz}$

$V_{CE} = \text{Parameter}$

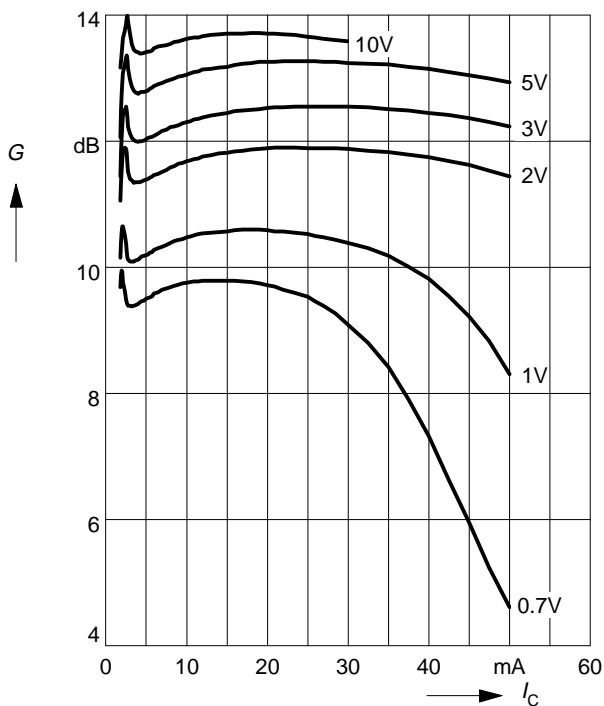

Power Gain $G_{ma}, G_{ms} = f(I_C)$

$f = 1.8\text{GHz}$

$V_{CE} = \text{Parameter}$

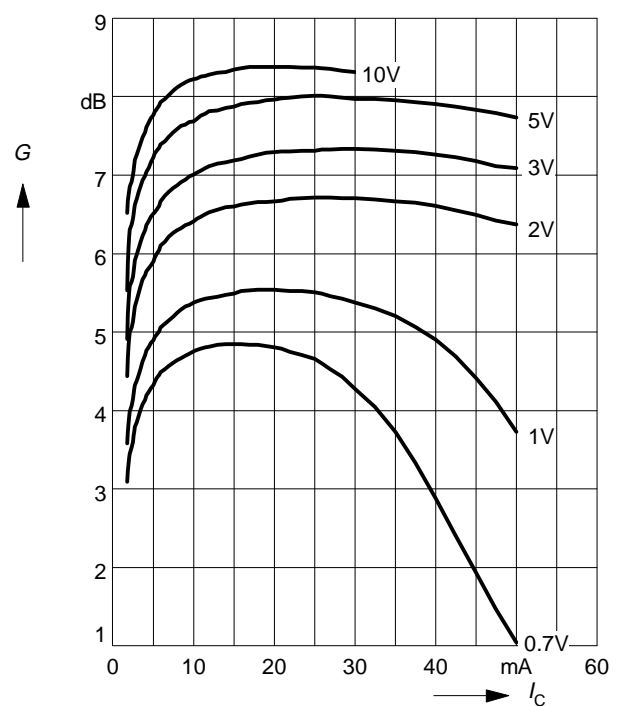

Power Gain $G_{ma}, G_{ms} = f(V_{CE})$: _____
 $|S_{21}|^2 = f(V_{CE})$: - - - - -

$f =$ Parameter

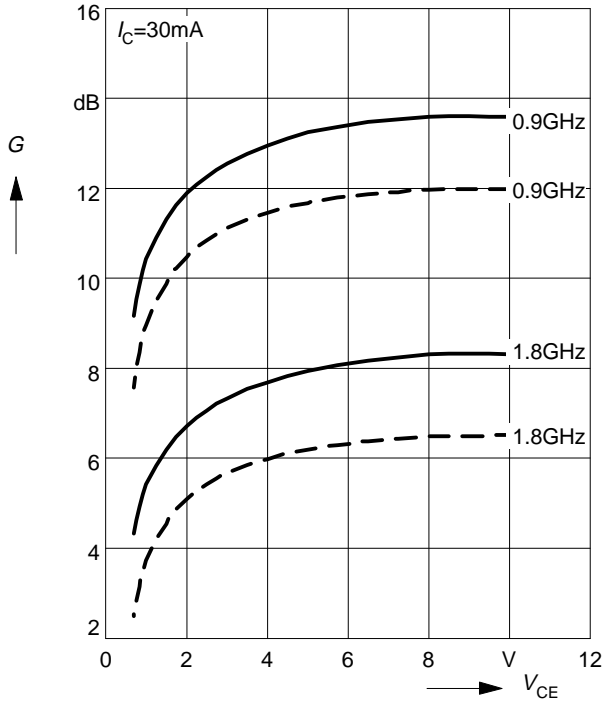

Intermodulation Intercept Point $IP_3 = f(I_C)$
 (3rd order, Output, $Z_S = Z_L = 50\Omega$)

$V_{CE} =$ Parameter, $f = 900\text{MHz}$

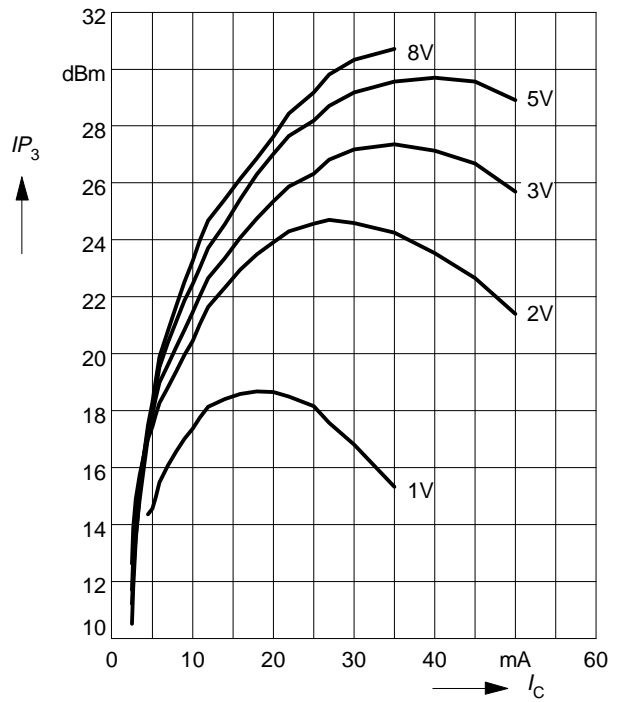

Power Gain $G_{ma}, G_{ms} = f(f)$

$V_{CE} =$ Parameter

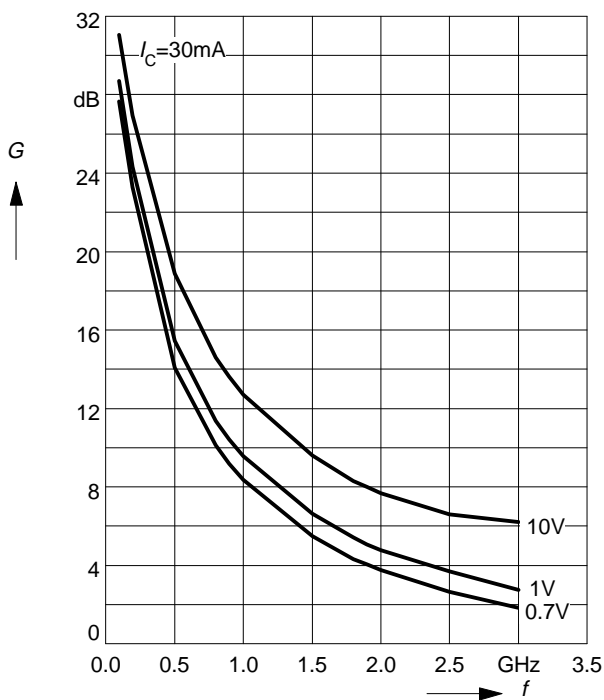

Power Gain $|S_{21}|^2 = f(f)$

$V_{CE} =$ Parameter

