

## WIDE BAND VHF/UHF AMPLIFIER

- SILICON PLANAR EPITAXIAL TRANSISTORS
- TO-72 METAL CASE
- VERY LOW NOISE

### APPLICATIONS :

- TELECOMMUNICATIONS
- WIDE BAND UHF AMPLIFIER
- RADIO COMMUNICATIONS

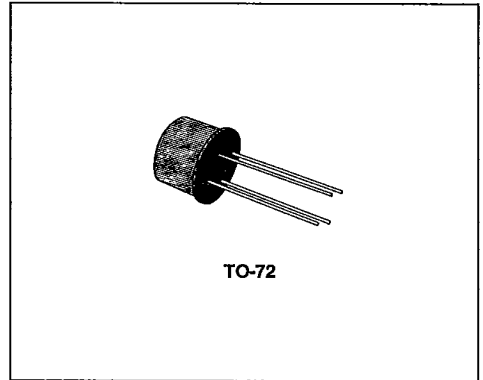

### DESCRIPTION

The BFX89 and BFY90 are silicon planar epitaxial NPN transistors produced using interdigitated base emitter geometry. They are particularly designed for use in wide band common-emitter linear amplifiers up to 1 GHz. They feature very high  $f_T$ , low reverse capacitance, excellent cross modulation properties and very low noise performance. The BFY90 is complementary to the BFR99A. Typical applications include telecommunication and radio communication equipment.

### INTERNAL SCHEMATIC DIAGRAM

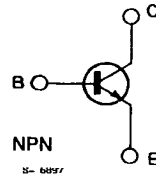

### ABSOLUTE MAXIMUM RATINGS

Symbol	Parameter	Value	Unit
$V_{CBO}$	Collector-base Voltage ( $I_E = 0$ )	30	V
$V_{CER}$	Collector-emitter Voltage ( $R_{BE} \leq 50 \Omega$ )	30	V
$V_{CEO}$	Collector-emitter Voltage ( $I_B = 0$ )	15	V
$V_{EBO}$	Emitter-base Voltage ( $I_C = 0$ )	2.5	V
$I_C$	Collector Current	25	mA
$I_{CM}$	Collector Peak Current ( $f \geq 1$ MHz)	50	mA
$P_{tot}$	Total Power Dissipation at $T_{amb} \leq 25^\circ C$	200	mW
$T_{stg}, T_j$	Storage and Junction Temperature	- 65 to 200	$^\circ C$

**THERMAL DATA**

$R_{th\ j-case}$	Thermal Resistance Junction-case	Max	580	°C/W
$R_{th\ j-amb}$	Thermal Resistance Junction-ambient	Max	880	°C/W

**ELECTRICAL CHARACTERISTICS** ( $T_{amb} = 25\ ^\circ C$  unless otherwise specified)

Symbol	Parameter	Test Conditions	Min.	Typ.	Max.	Unit
$I_{CBO}$	Collector Cutoff Current ( $I_E = 0$ )	$V_{CB} = 15\ V$			10	nA
$V_{CEK}^*$	Collector-emitter Knee Voltage	$I_C = 20\ mA$			0.75	V
$h_{FE}$	DC Current Gain	$I_C = 2\ mA$ $V_{CE} = 1\ V$ for <b>BFX89</b> for <b>BFY90</b>	20 25		150 150	
		$I_C = 25\ mA$ $V_{CE} = 1\ V$	20		125	
$f_T$	Transition Frequency	$V_{CE} = 5\ V$ $f = 500\ MHz$ $I_C = 2\ mA$  for <b>BFX89</b> for <b>BFY90</b>	1	1 1.1		GHz GHz
		$I_C = 25\ mA$  for <b>BFX89</b> for <b>BFY90</b>	1.3	1.2 1.4		GHz GHz
$C_{CBO}^{(1)}$	Collector-base Capacitance	$I_E = 0$ $V_{CB} = 10\ V$ $f = 1\ MHz$ for <b>BFX89</b> for <b>BFY90</b>			1.7 1.5	pF pF
$C_{re}^{(2)}$	Reverse Capacitance	$I_C = 2\ mA$ $V_{CE} = 5\ V$ $f = 1\ MHz$ for <b>BFX89</b> for <b>BFY90</b>		0.6 0.6	0.8	pF pF
$NF^{(2)}$	Noise Figure	$I_C = 2\ mA$ $V_{CE} = 5\ V$ $R_g = \text{Optimized}$ $f = 100\ kHz$ for <b>BFY90</b> Only $f = 200\ MHz$  $R_g = \text{Optimized}$ for <b>BFX89</b> for <b>BFY90</b> $f = 500\ MHz$  $R_g = 50\ \Omega$ for <b>BFX89</b> for <b>BFY90</b> $f = 800\ MHz$  $R_g = \text{Optimized}$ for <b>BFX89</b> for <b>BFY90</b> $f = 800\ MHz$			4  3.3 2.5 3.5  6.5 5  7 5.5	dB  dB dB  dB dB  dB dB
$G_{pe}^{(2)}$	Power Gain (not neutralized)	for <b>BFX89</b> $I_C = 8\ mA$ $V_{CE} = 10\ V$ $f = 200\ MHz$ $f = 800\ MHz$  for <b>BFY90</b> $I_C = 14\ mA$ $V_{CE} = 10\ V$ $f = 200\ MHz$ $f = 800\ MHz$	19  21	22 7  23 8		dB dB  dB dB

\*  $I_B$  = value for which  $I_C = 22\ mA$  at  $V_{CE} = 1\ V$

(1) Shield lead not grounded

(2) Shield lead grounded

(3)  $f_p = 202\ MHz$ ,  $f_q = 205\ MHz$ ,  $f_{(2q,p)} = 208\ MHz$

(4)  $f_p = 798\ MHz$ ,  $f_q = 802\ MHz$ ,  $f_{(2q,p)} = 806\ MHz$

SGS-THOMSON

T-31-15

ELECTRICAL CHARACTERISTICS (continued)

Symbol	Parameter	Test Conditions	Min.	Typ.	Max.	Unit
P <sub>o</sub>	Output Power	for <b>BFX89</b> I <sub>C</sub> = 8 mA      V <sub>CE</sub> = 10 V d <sub>m</sub> = -30 dB (3) Channel 9 (4) Channel 62		6		mW
		for <b>BFY90</b> I <sub>C</sub> = 14 mA      V <sub>CE</sub> = 10 V d <sub>m</sub> = -30 dB (3) Channel 9 (4) Channel 62	10	12	12	mW

\* I<sub>b</sub> = value for which I<sub>C</sub> = 22 mA at V<sub>CE</sub> = 1 V

- (1) Shield lead not grounded
- (2) Shield lead grounded

- (3) f<sub>p</sub> = 202 MHz, f<sub>q</sub> = 205 MHz, f<sub>2qP</sub> = 208 MHz
- (4) f<sub>p</sub> = 798 MHz, f<sub>q</sub> = 802 MHz, f<sub>2qP</sub> = 806 MHz

Power Rating Chart.

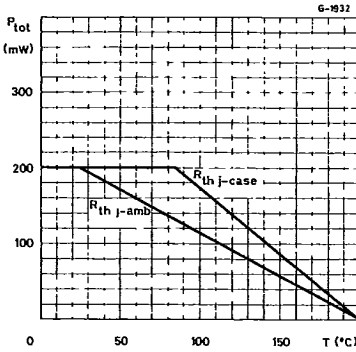

Transition Frequency.

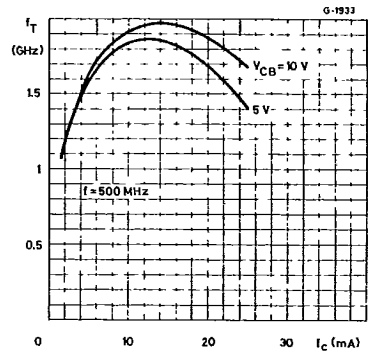

Collector-base Capacitance.

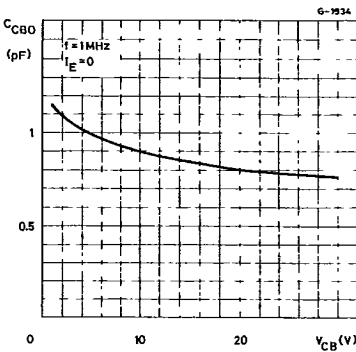

Noise Figure vs. Collector Current.

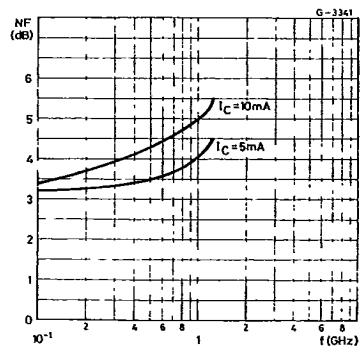

Noise Figure vs. Frequency.

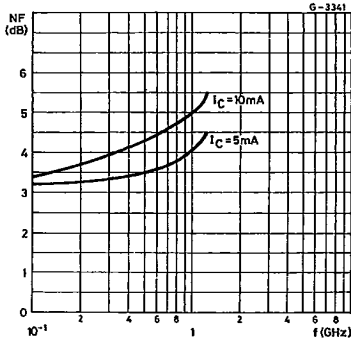

Forward Transmission Gain vs. Frequency.

