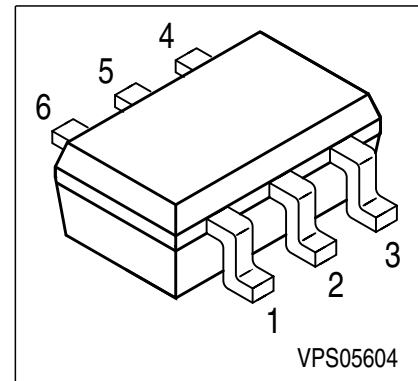
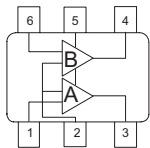
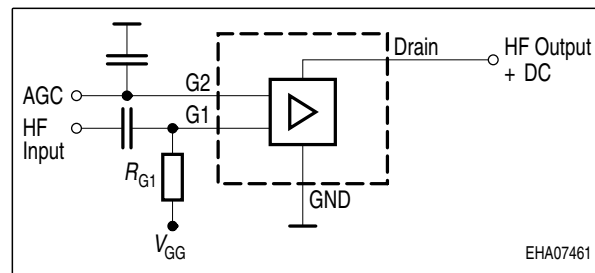
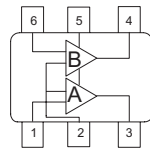

DUAL N-Channel MOSFET Tetrode

- Two gain controlled input stages for UHF and VHF -tuners e.g. (NTSC, PAL)
- Optimized for UHF (amp. B) and VHF (amp. A)
- Integrated gate protection diodes
- High AGC-range, low noise figure, high gain
- Improved cross modulation at gain reduction

BG3123

BG3123R

ESD: Electrostatic discharge sensitive device, observe handling precaution!

Type	Package	Pin Configuration						Marking
BG3123	SOT363	1=G1*	2=G2	3=D*	4=D**	5=S	6=G1**	KOs
BG3123R***	SOT363	1=G1**	2=S	3=D**	4=D*	5=G2	6=G1*	KRs

* For amp. A; ** for amp. B

*** Target Data

180° rotated tape loading orientation available

Maximum Ratings

Parameter	Symbol	Value	Unit
Drain-source voltage	V_{DS}	8	V
Continuous drain current	I_D		mA
amp. A		25	
amp. B		20	
Gate 1/ gate 2-source current	$\pm I_{G1/2SM}$	1	
Gate 1/ gate 2-source voltage	$\pm V_{G1/G2S}$	6	V
Total power dissipation	P_{tot}	200	mW
Storage temperature	T_{stg}	-55 ... 150	°C
Channel temperature	T_{ch}	150	

Thermal Resistance

Parameter	Symbol	Value	Unit
Channel - soldering point ¹⁾	R_{thchs}	≤ 150	K/W

Electrical Characteristics

Parameter	Symbol	Values			Unit
		min.	typ.	max.	

DC Characteristics

Drain-source breakdown voltage $I_D = 10 \mu A, V_{G1S} = 0 V, V_{G2S} = 0 V$	$V_{(BR)DS}$	12	-	-	V
Gate1-source breakdown voltage $+I_{G1S} = 10 mA, V_{G2S} = 0 V, V_{DS} = 0 V$	$+V_{(BR)G1SS}$	6	-	15	
Gate2-source breakdown voltage $+I_{G2S} = 10 mA, V_{G1S} = 0 V, V_{DS} = 0 V$	$+V_{(BR)G2SS}$	6	-	15	
Gate1-source leakage current $V_{G1S} = 6 V, V_{G2S} = 0 V$	$+I_{G1SS}$	-	-	50	μA
Gate2-source leakage current $V_{G2S} = 8 V, V_{G1S} = 0 V, V_{DS} = 0 V$	$+I_{G2SS}$	-	-	50	nA
Drain current $V_{DS} = 5 V, V_{G1S} = 0 V, V_{G2S} = 4.5 V$	I_{DSS}	-	-	10	μA
Drain-source current $V_{DS} = 5 V, V_{G2S} = 4 V, R_{G1} = 60 k\Omega,$ amp. A $V_{DS} = 5 V, V_{G2S} = 4 V, R_{G1} = 50 k\Omega,$ amp. B	I_{DSX}	-	14	-	mA
Gate1-source pinch-off voltage $V_{DS} = 5 V, V_{G2S} = 4 V, I_D = 20 \mu A$	$V_{G1S(p)}$	-	0.7	-	V
Gate2-source pinch-off voltage $V_{DS} = 5 V, I_D = 20 \mu A$	$V_{G2S(p)}$	-	0.6	-	

¹⁾For calculation of R_{thJA} please refer to Application Note Thermal Resistance

Electrical Characteristics

Parameter	Symbol	Values			Unit
		min.	typ.	max.	
AC Characteristics $V_{DS} = 5V$, $V_{G2S} = 4V$, ($I_D = 14$ mA) (verified by random sampling)					
Forward transconductance amp. A amp. B	g_{fs}	- - -	30 25	- - -	mS
Gate1 input capacitance $f = 10$ MHz, amp. A $f = 10$ MHz, amp. B	C_{g1ss}	- -	1.9 1.5	- -	pF
Output capacitance $f = 10$ MHz, amp. A $f = 10$ MHz, amp. B	C_{dss}	- -	1.3 1.1	- -	
Power gain $f = 800$ MHz, amp. A $f = 800$ MHz, amp. B $f = 45$ MHz, amp. A $f = 45$ MHz, amp. B	G_p	- - - -	25 24 32 30	- - - -	dB
Noise figure $f = 800$ MHz, amp. A $f = 800$ MHz, amp. B $f = 45$ MHz, amp. A $f = 45$ MHz, amp. B	F	- - - -	1.8 1.8 1.4 1.6	- - - -	dB
Gain control range $V_{G2S} = 4 \dots 0$ V, $f = 800$ MHz	ΔG_p	45	-	-	
Cross-modulation $k=1\%$, $f_w=50$ MHz, $f_{unw}=60$ MHz amp.A, AGC = 0 dB amp. B, AGC = 0 dB amp. A, AGC = 10 dB amp. B, AGC = 10 dB amp. A, AGC = 40 dB amp. B, AGC = 40 dB	X_{mod}	90 90 - - 98 98	96 97 91 94 103 104	- - - - - -	-

Total power dissipation $P_{tot} = f(T_S)$

amp. A

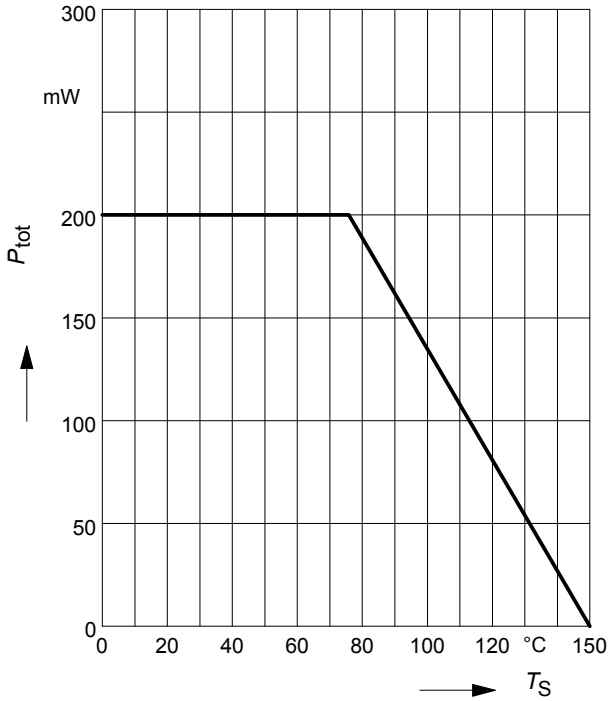

Total power dissipation $P_{tot} = f(T_S)$

amp. B

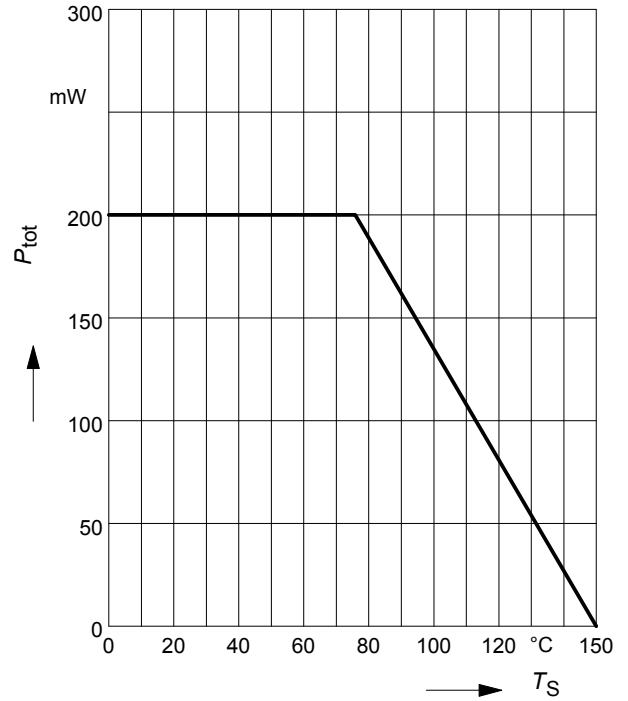

Drain current $I_D = f(I_{G1})$

$V_{G2S} = 4V$

amp. A

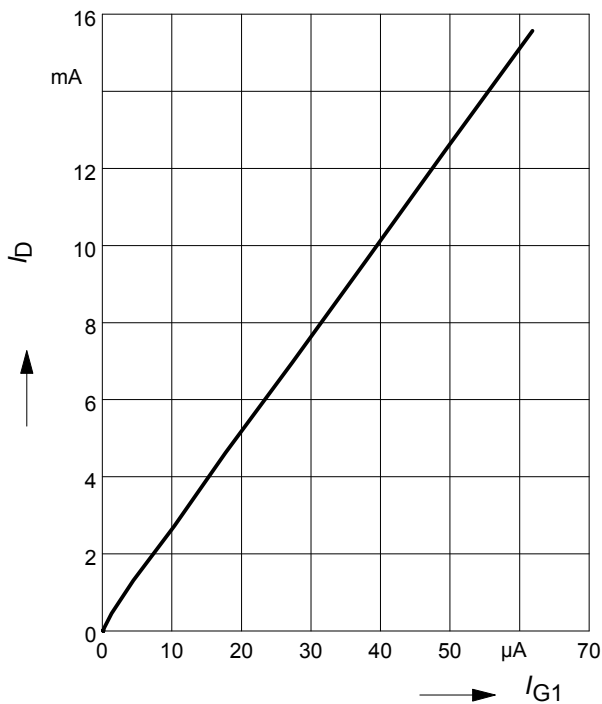

Drain current $I_D = f(I_{G1})$

$V_{G2S} = 4V$

amp. B

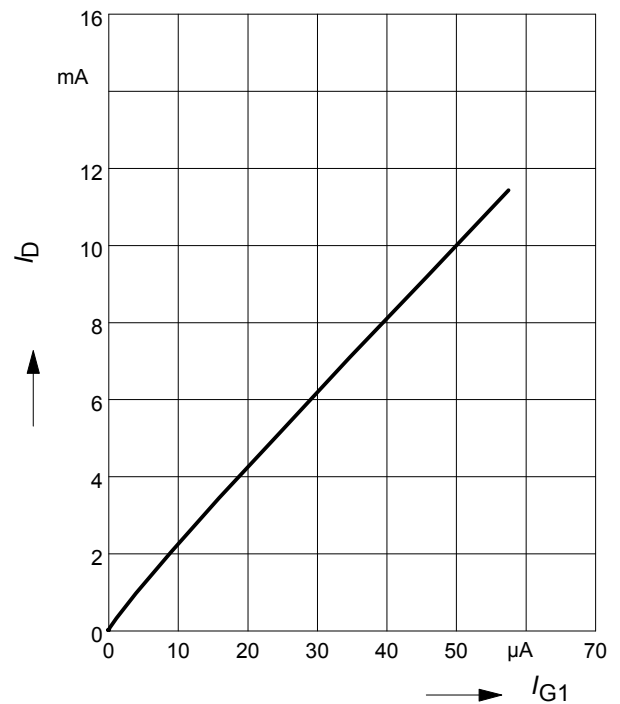

Output characteristics $I_D = f(V_{DS})$

$V_{G2S} = 4V$, $V_{G1S} = \text{Parameter in V}$
amp. A

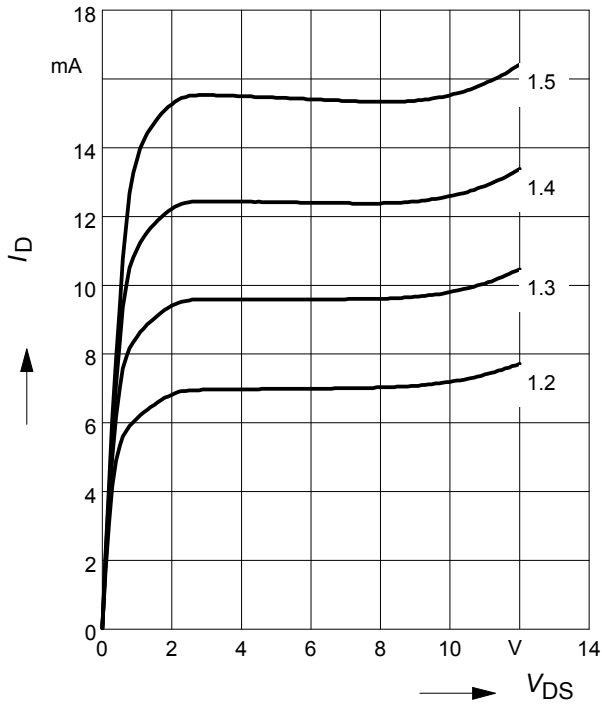

Output characteristics $I_D = f(V_{DS})$

$V_{G2S} = 4V$, $V_{G1S} = \text{Parameter in V}$
amp. B

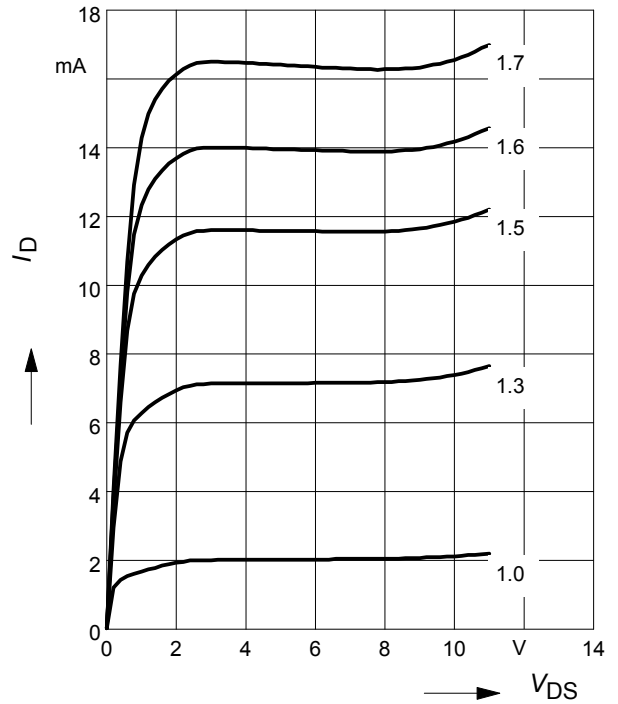

Gate 1 current $I_{G1} = f(V_{G1S})$

$V_{DS} = 5V$, $V_{G2S} = \text{Parameter in V}$
amp. A

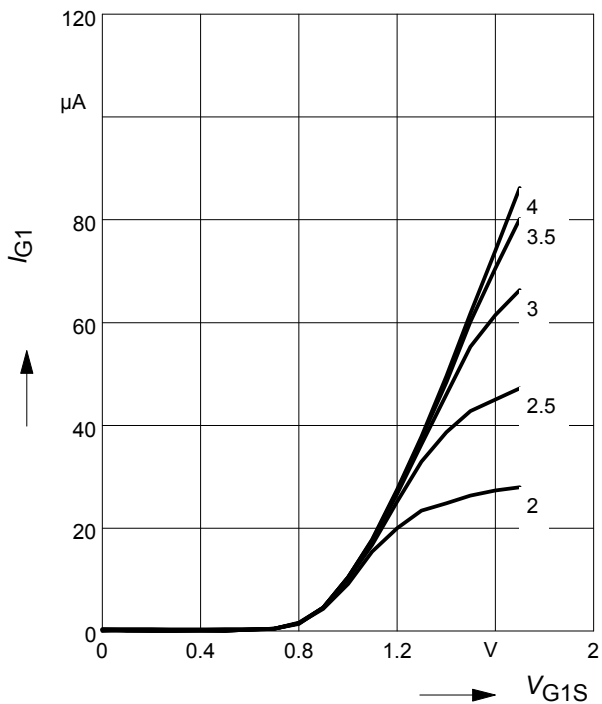

Gate 1 current $I_{G1} = f(V_{G1S})$

$V_{DS} = 5V$, $V_{G2S} = \text{Parameter in V}$
amp. B

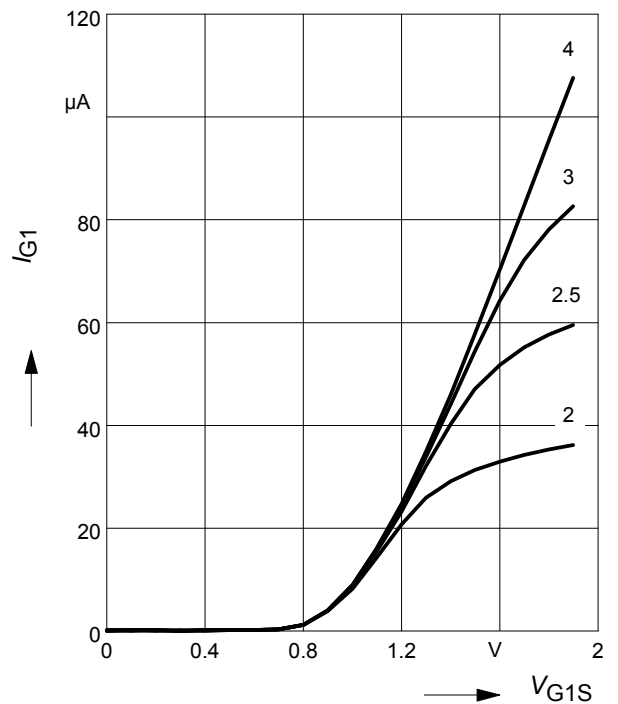

Gate 1 forward transconductance

$g_{fs} = f(I_D)$, $V_{DS} = 5V$, $V_{G2S} = \text{Parameter}$
amp. A

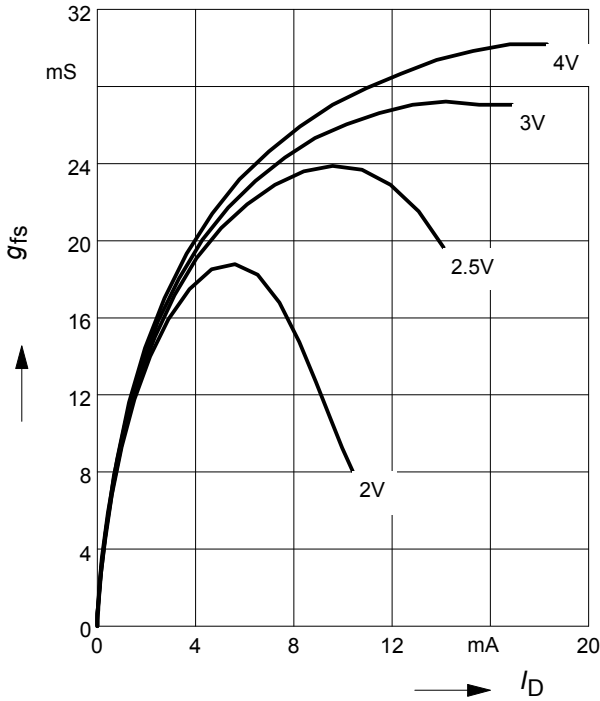

Gate 1 forward transconductance

$g_{fs} = f(I_D)$, $V_{DS} = 5V$, $V_{G2S} = \text{Parameter}$
amp. B

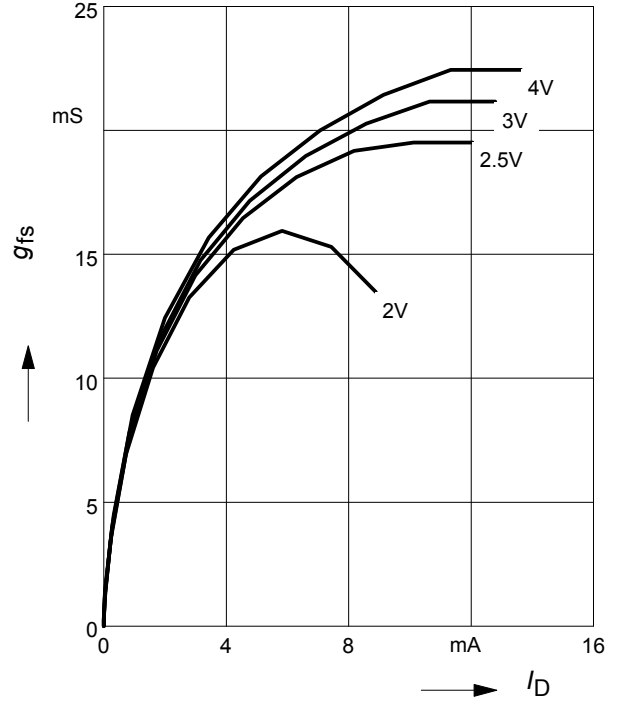

Drain current $I_D = f(V_{G1S})$

$V_{DS} = 5V$, $V_{G2S} = \text{Parameter}$
amp. A

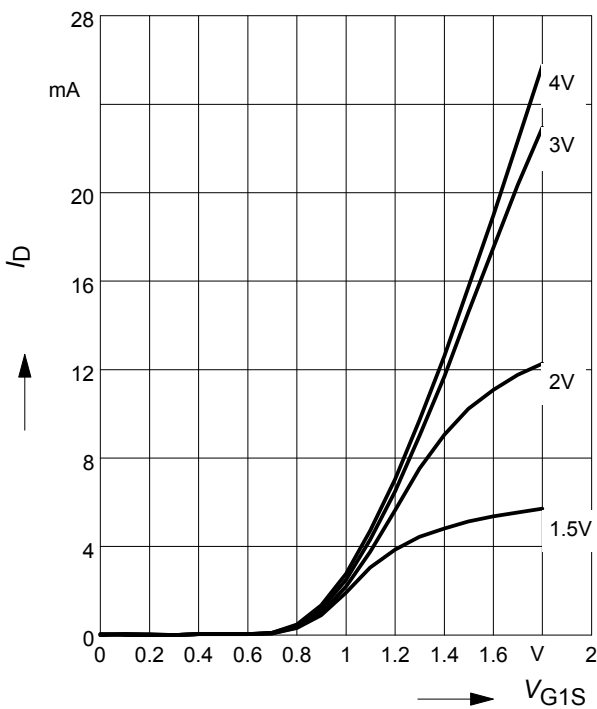

Drain current $I_D = f(V_{G1S})$

$V_{DS} = 5V$, $V_{G2S} = \text{Parameter}$
amp. B

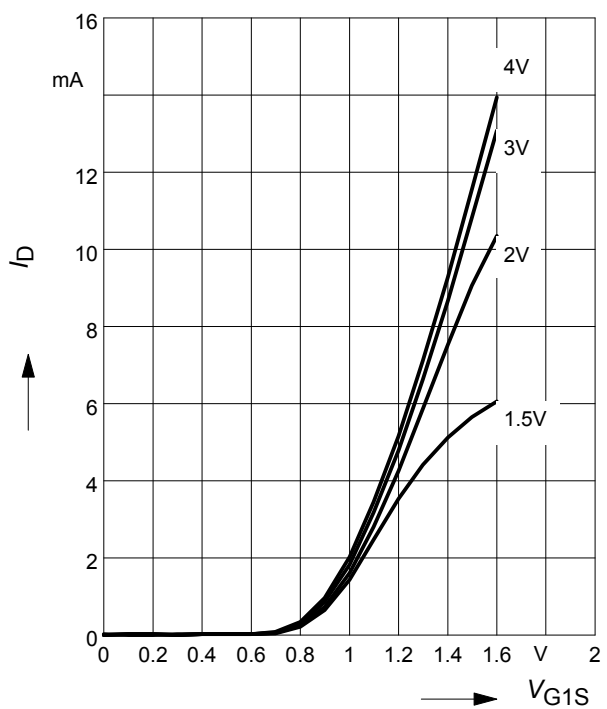

Drain current $I_D = f(V_{GG})$ amp. A

$V_{DS} = 5V, V_{G2S} = 4V, R_{G1} = 60k\Omega$

(connected to $V_{GG}, V_{GG}=\text{gate1 supply voltage}$)

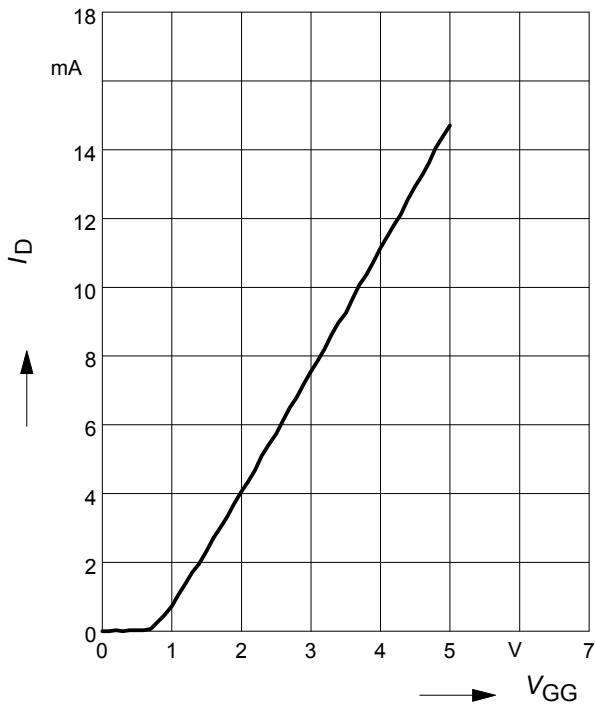

Drain current $I_D = f(V_{GG})$ amp. B

$V_{DS} = 5V, V_{G2S} = 4V, R_{G1} = 50k\Omega$

(connected to $V_{GG}, V_{GG}=\text{gate1 supply voltage}$)

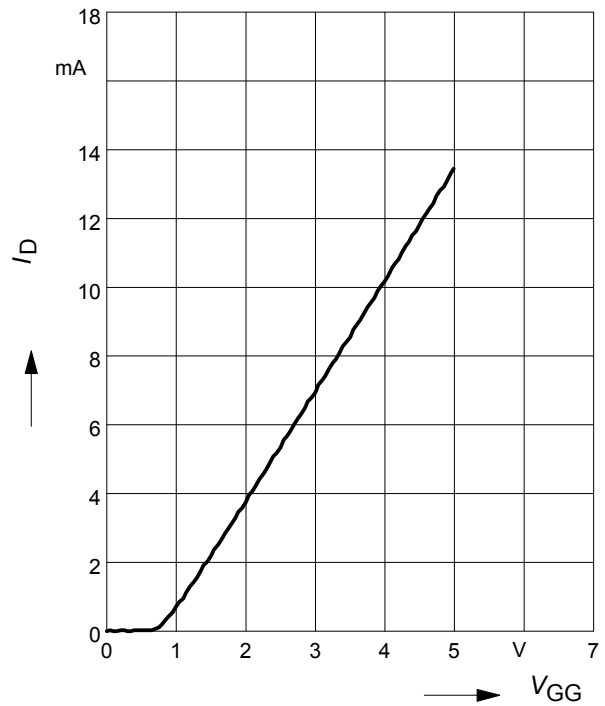

Drain current $I_D = f(V_{GG})$

$V_{G2S} = 4V, R_{G1} = \text{Parameter in } k\Omega$

amp. A

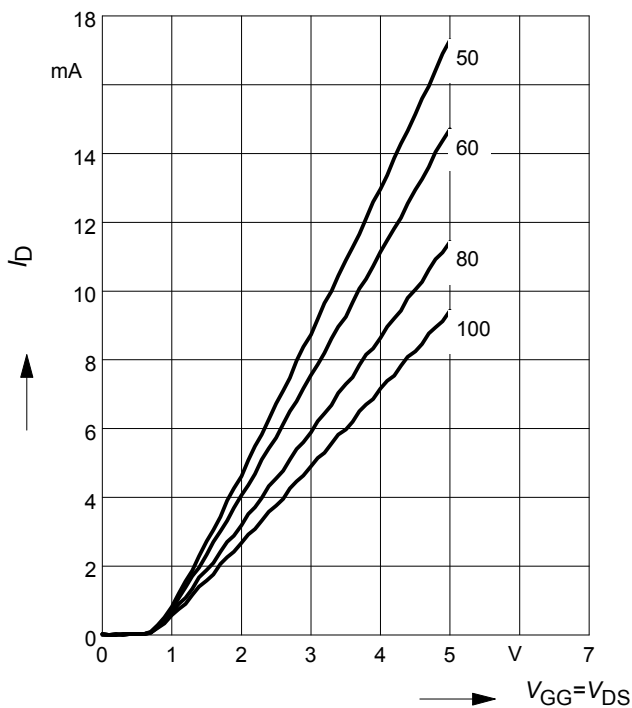

Drain current $I_D = f(V_{GG})$

$V_{G2S} = 4V, R_{G1} = \text{Parameter in } k\Omega$

amp. B

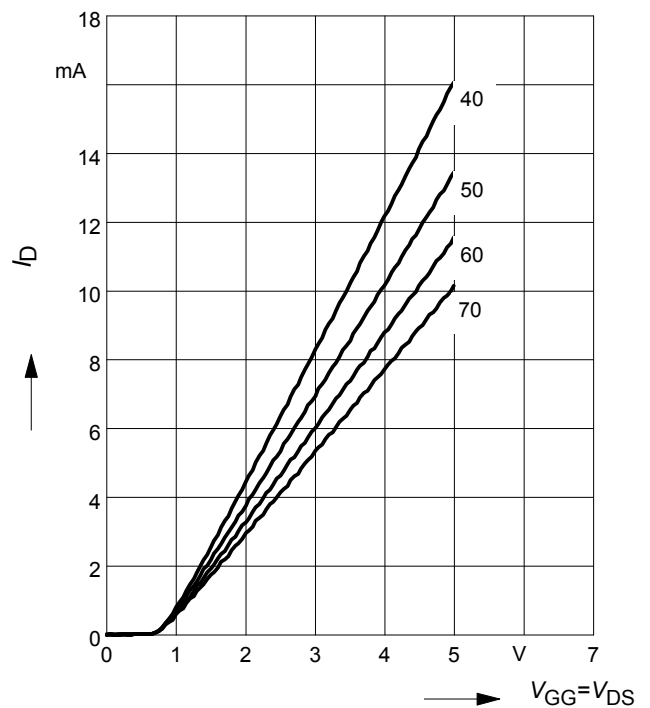

Crossmodulation $V_{unw} = (AGC)$

$V_{DS} = 5\text{ V}$, $R_{g1} = 68\text{ k}\Omega$

amp.A

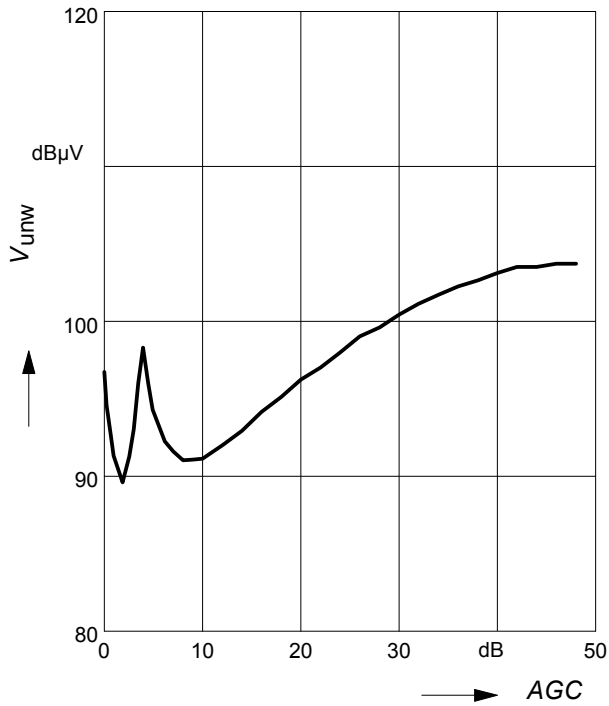

Crossmodulation $V_{unw} = (AGC)$

$V_{DS} = 5\text{ V}$, $R_{g1} = 56\text{ k}\Omega$

amp.B

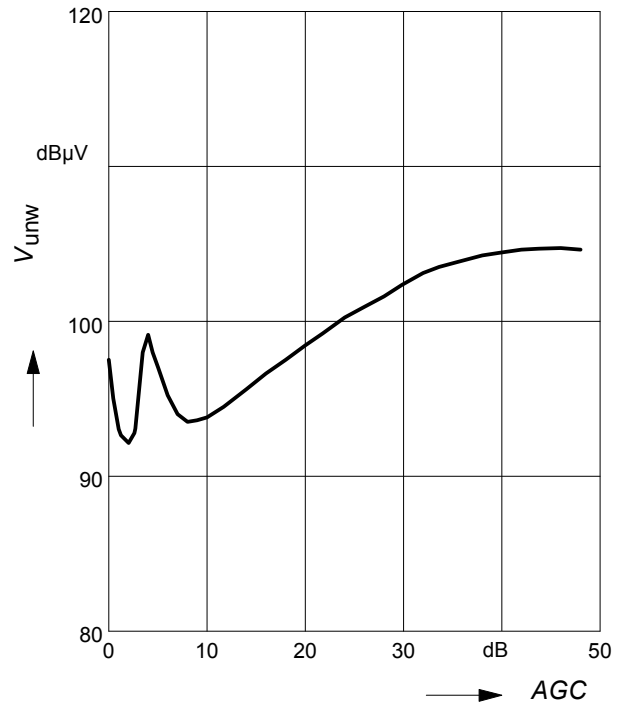

Crossmodulation test circuit

