

DATA SHEET

BGY205 UHF amplifier module

Product specification
Supersedes data of May 1994

1996 May 21

UHF amplifier module

BGY205

FEATURES

- 6 V nominal supply voltage
- 3.5 W pulsed output power
- Easy control of output power by DC voltage.

APPLICATIONS

- Digital cellular radio systems with Time Division Multiple Access (TDMA) operation (GSM systems) in the 880 to 915 MHz frequency range.

DESCRIPTION

The BGY205 is a four-stage UHF amplifier module in a SOT321B package. The module consists of four NPN silicon planar transistor dies mounted together with matching and bias circuit components on a metallized ceramic substrate.

PINNING - SOT321B

PIN	DESCRIPTION
1	RF input
2	V _C
3	V _S
4	RF output
Flange	ground

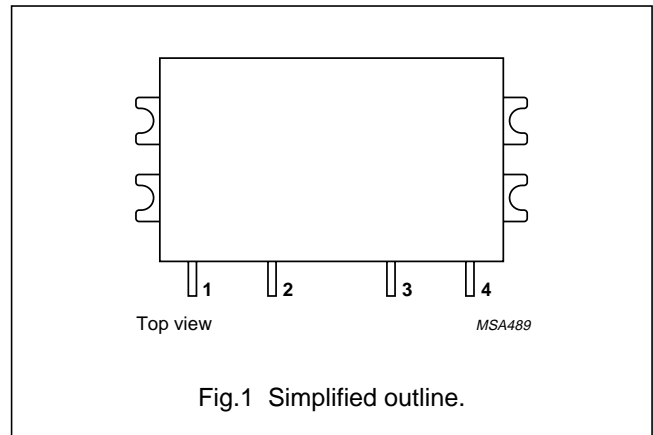

QUICK REFERENCE DATA

RF performance at T_{mb} = 25 °C.

MODE OF OPERATION	f (MHz)	V _S (V)	V _C (V)	P _L (W)	G _p (dB)	η (%)	Z _S ; Z _L (Ω)
Pulsed; δ = 1 : 8	880 to 915	6	≤4	3.5	≥32.5	≥40	50

UHF amplifier module

BGY205

LIMITING VALUES

In accordance with the Absolute Maximum Rating System (IEC 134).

SYMBOL	PARAMETER	MIN.	MAX.	UNIT
V_S	DC supply voltage	–	8.5	V
V_C	DC control voltage	–	4.5	V
P_D	input drive power	–	7	mW
P_L	load power	–	4	W
T_{stg}	storage temperature	–40	+100	°C
T_{mb}	operating mounting base temperature	–30	+100	°C

CHARACTERISTICS

$Z_S = Z_L = 50 \Omega$; $P_D = 3$ dBm; $V_S = 6$ V; $V_C \leq 4$ V; $f = 880$ to 915 MHz; $T_{mb} = 25$ °C; $\delta = 1 : 8$; $t_p = 575$ μ s; unless otherwise specified.

SYMBOL	PARAMETER	CONDITIONS	MIN.	TYP.	MAX.	UNIT
I_Q	leakage current	$V_C = 0.5$ V	–	–	100	μ A
I_C	control current	adjust V_C for $P_L = 3.5$ W	–	–	500	μ A
P_L	load power	$V_C = 4$ V	3.5	–	–	W
G_p	power gain	adjust V_C for $P_L = 3.5$ W	32.5	–	–	dB
η	efficiency	adjust V_C for $P_L = 3.5$ W	40	45	–	%
H_2	second harmonic	adjust V_C for $P_L = 3.5$ W	–	–	–40	dBc
H_3	third harmonic	adjust V_C for $P_L = 3.5$ W	–	–	–40	dBc
$VSWR_{in}$	input VSWR	adjust V_C for $P_L = 3.5$ W	–	–	2 : 1	
	stability	$P_D = 0$ to 6 dBm; $V_S = 5$ to 8.5 V; $V_C = 0$ to 4 V; $P_L \leq 3.5$ W; $VSWR \leq 6 : 1$ through all phases	–	–	–60	dBc
	isolation	$V_C = 0.5$ V	–	–	–36	dBm
	control bandwidth	$R1 = 0$; $C1 = 0$; see Fig.16	1	–	–	MHz
	AM-AM conversion	P_D with 3% AM; $f = 100$ kHz; $P_L = 3.5$ mW to 3.5 W	–	–	12	%
P_n	noise power	$P_L = 3.5$ W; bandwidth = 30 kHz; 20 MHz above transmitter band	–	–	–85	dBm
	ruggedness	$V_S = 8.5$ V; adjust V_C for $P_L = 3.5$ W; $VSWR \leq 10 : 1$ through all phases	no degradation			

UHF amplifier module

BGY205

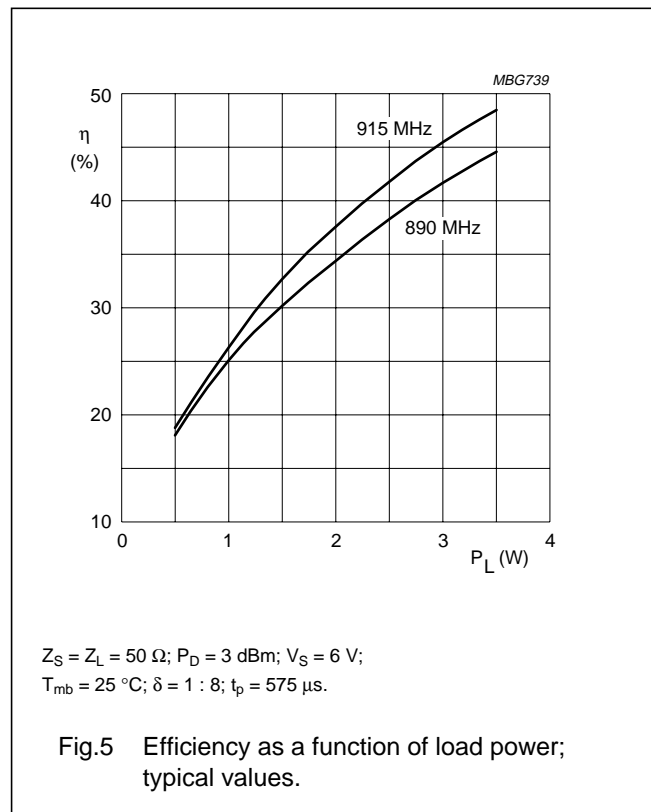
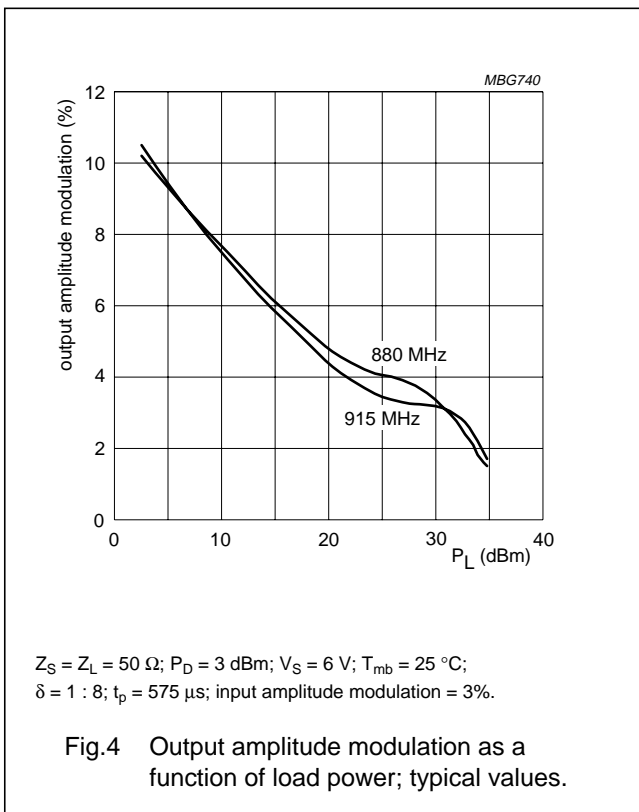
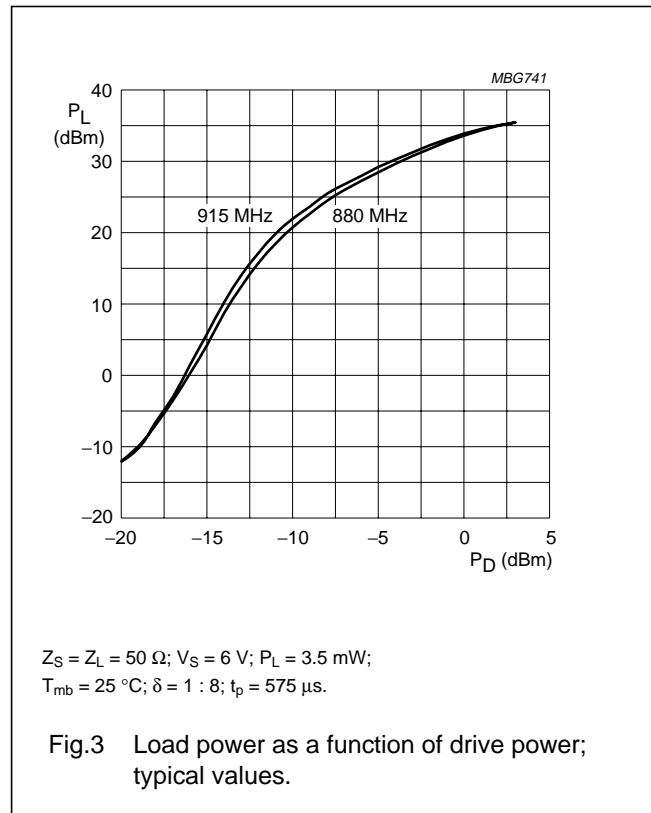
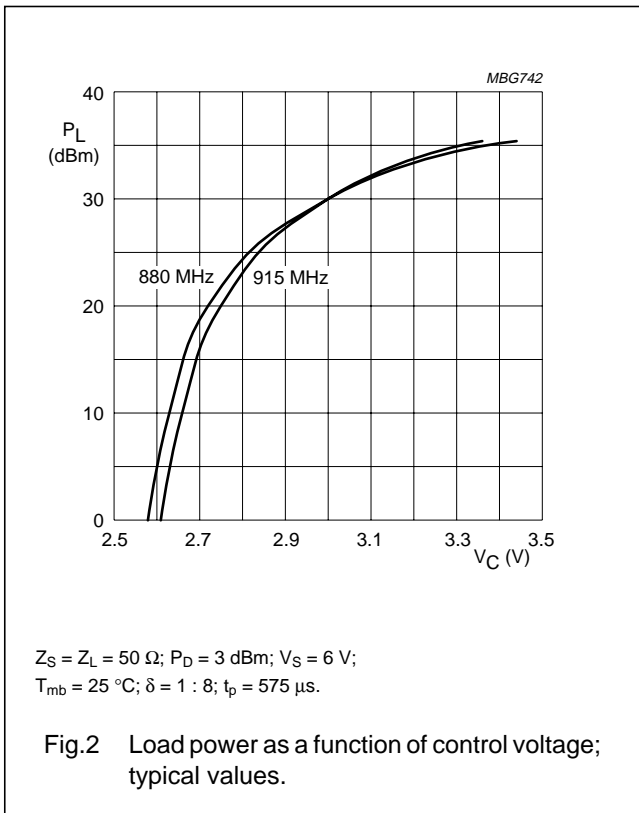

UHF amplifier module

BGY205

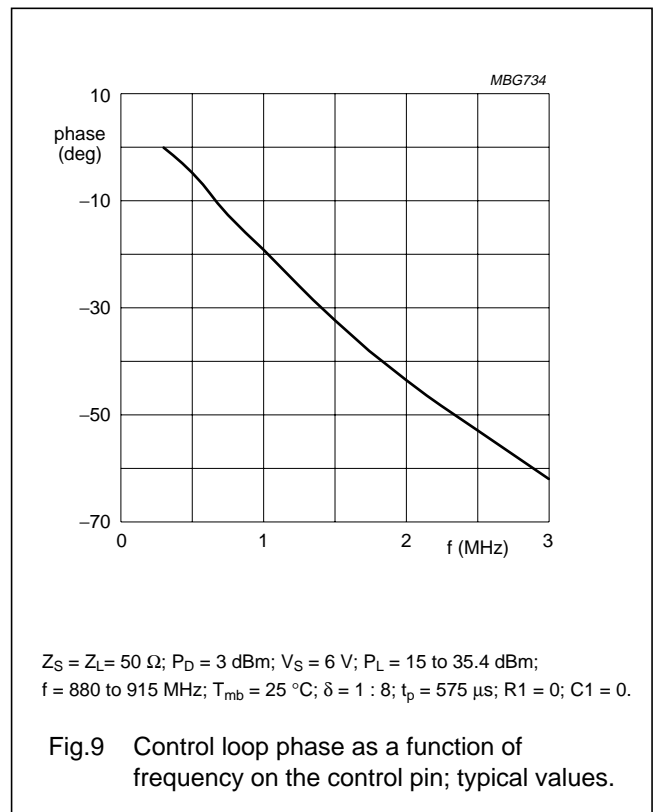
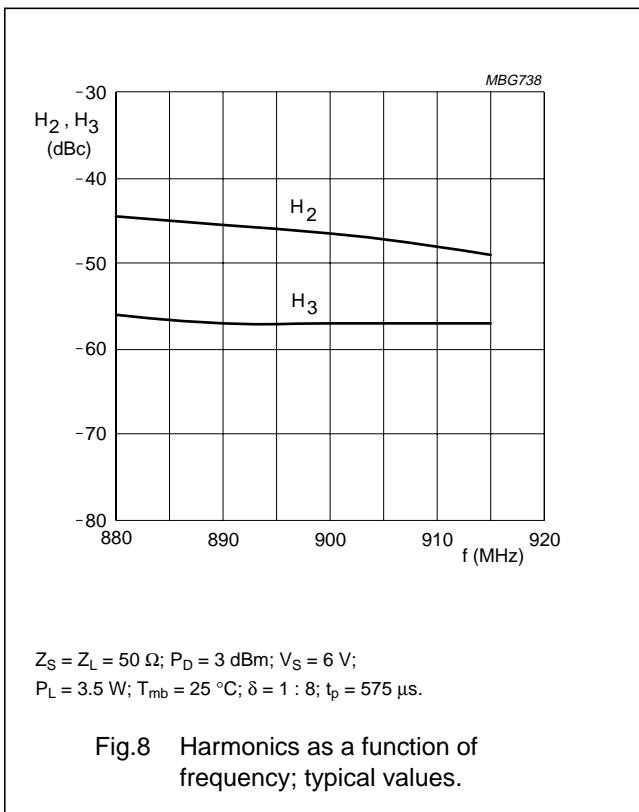
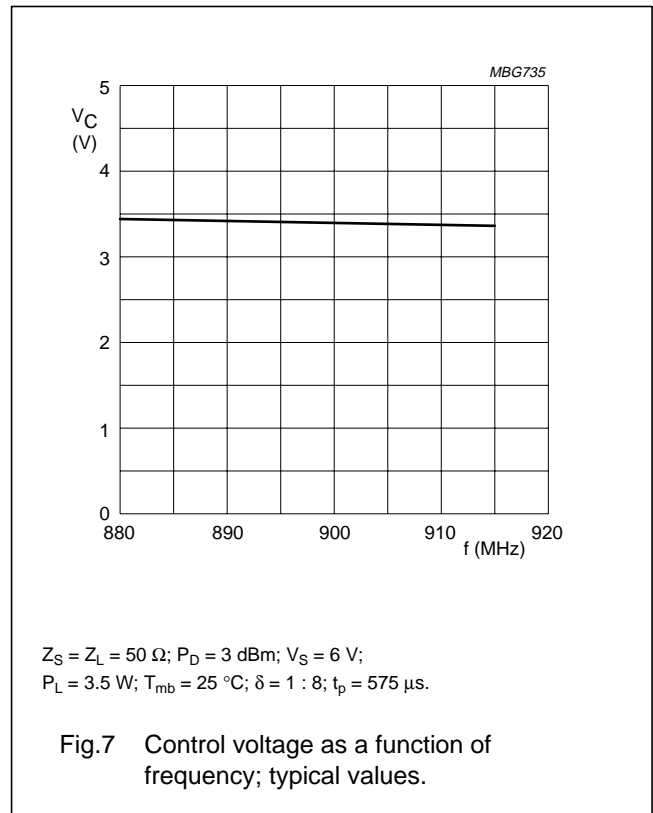
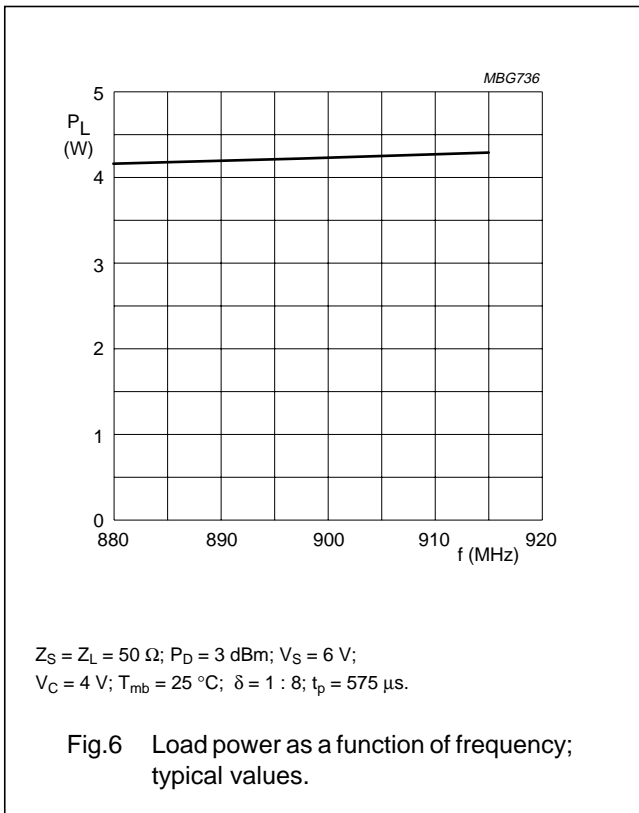

UHF amplifier module

BGY205

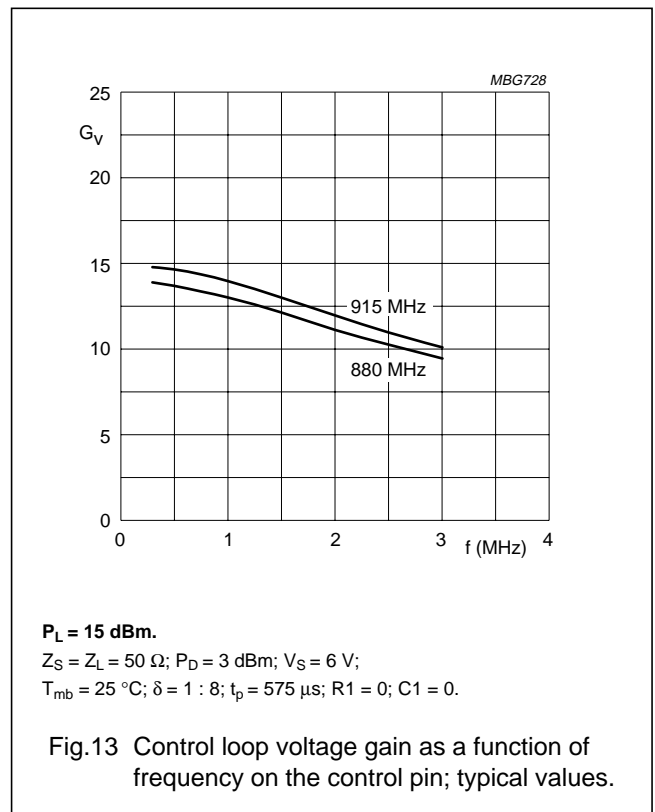
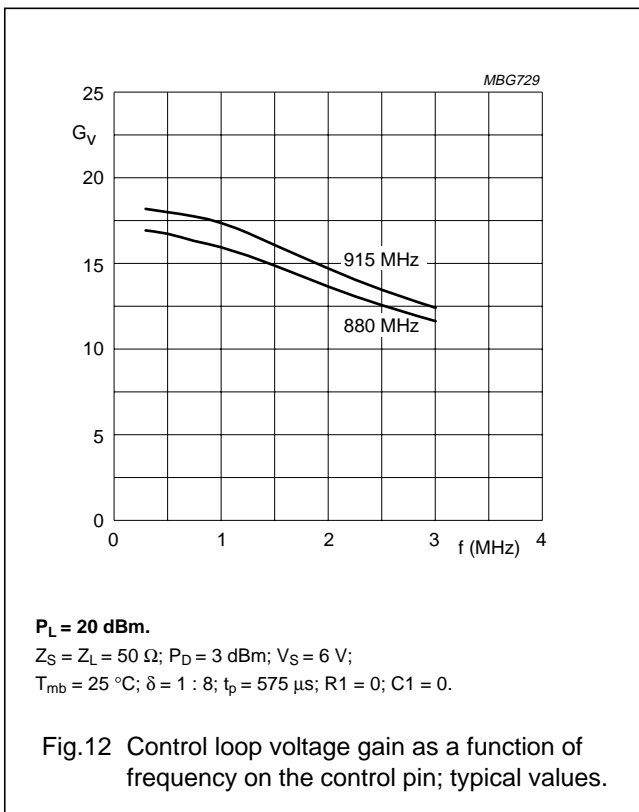
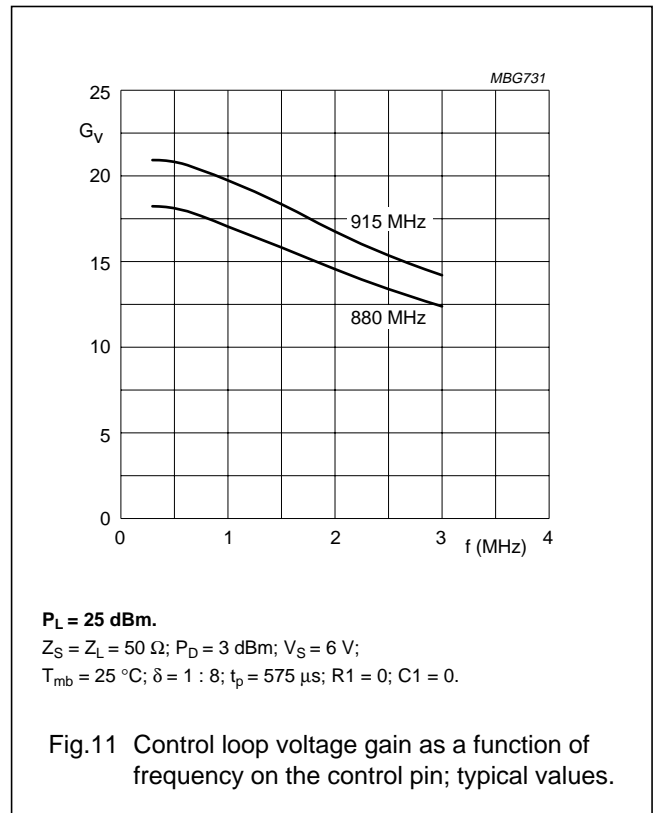
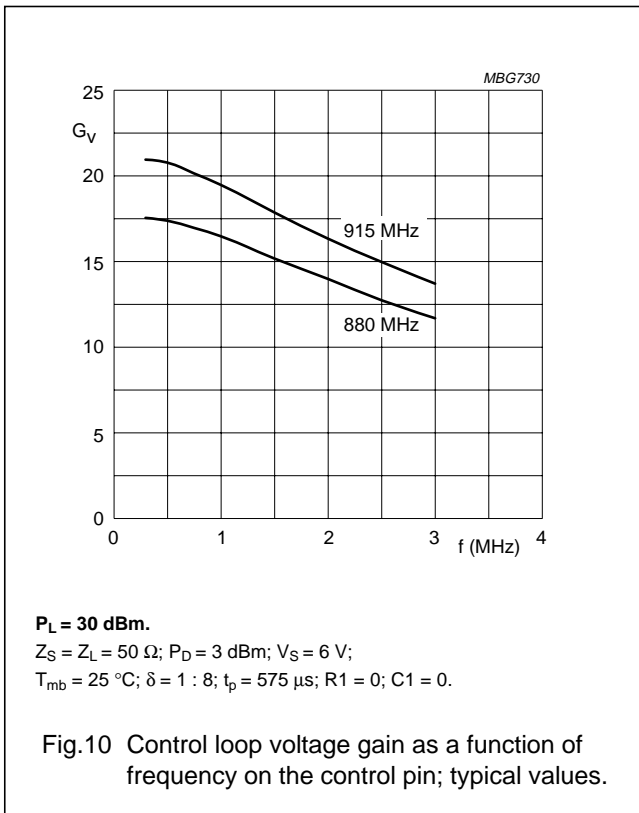

UHF amplifier module

BGY205

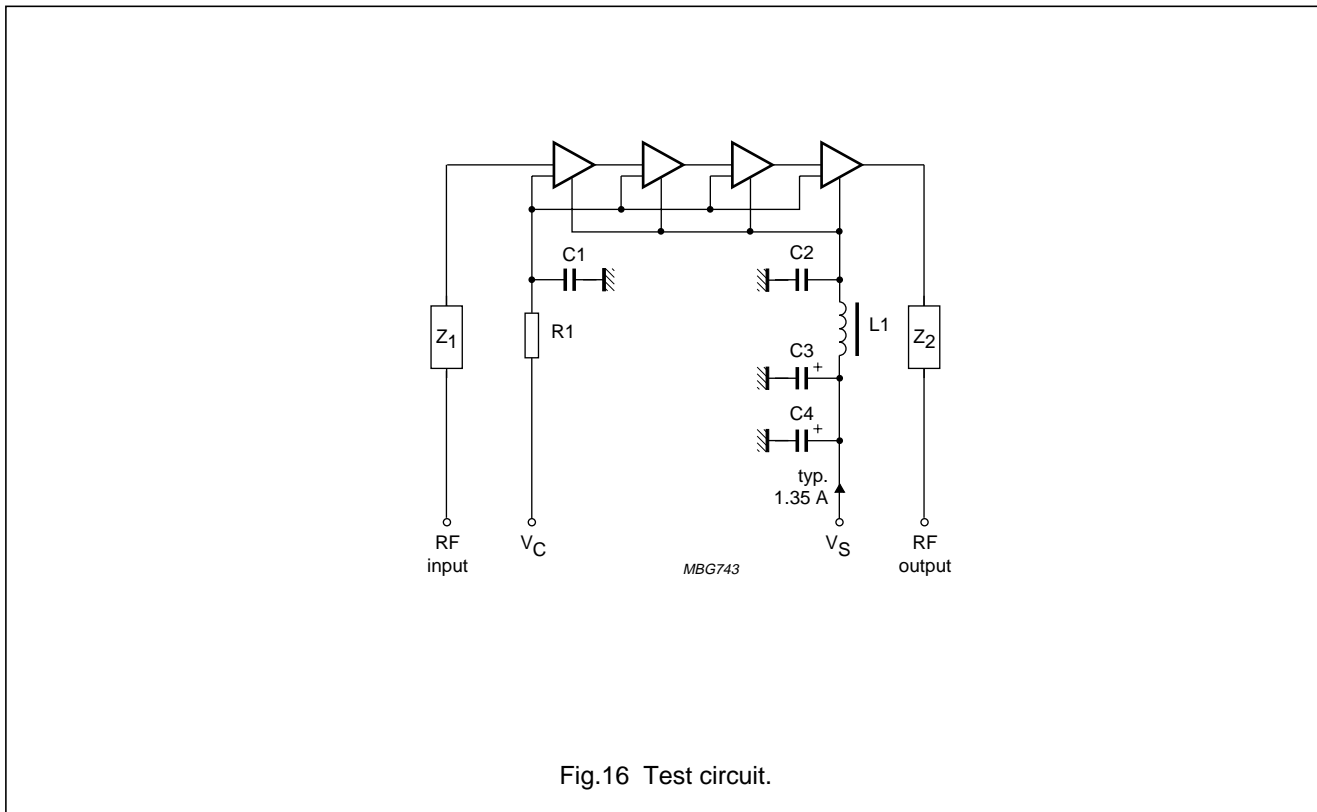
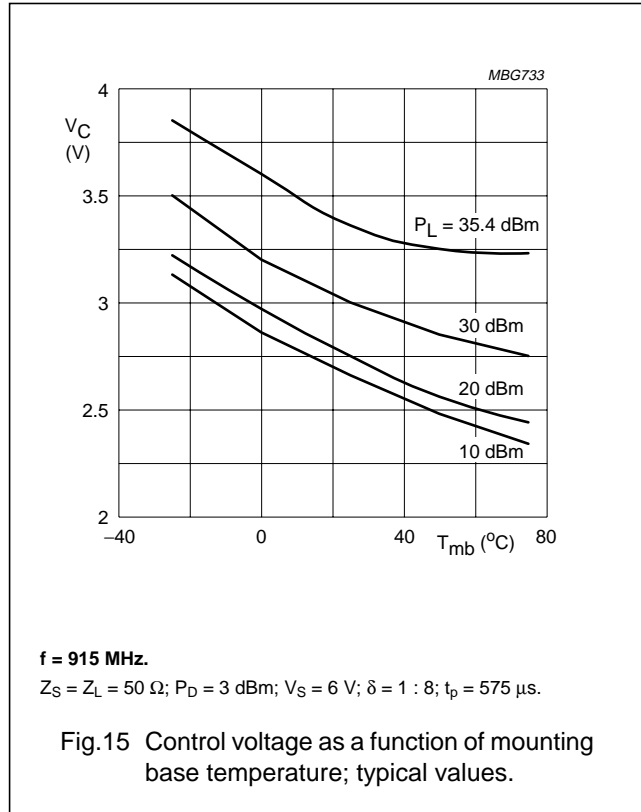
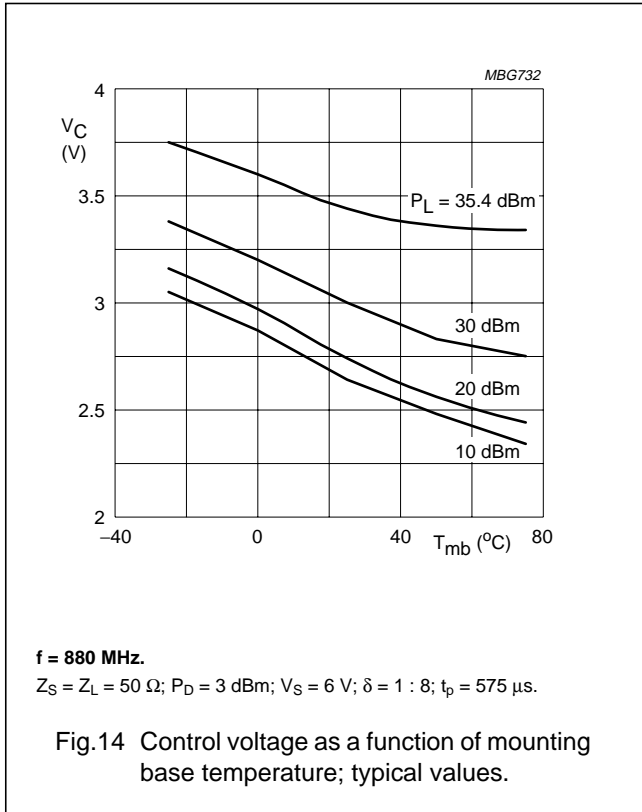

UHF amplifier module

BGY205

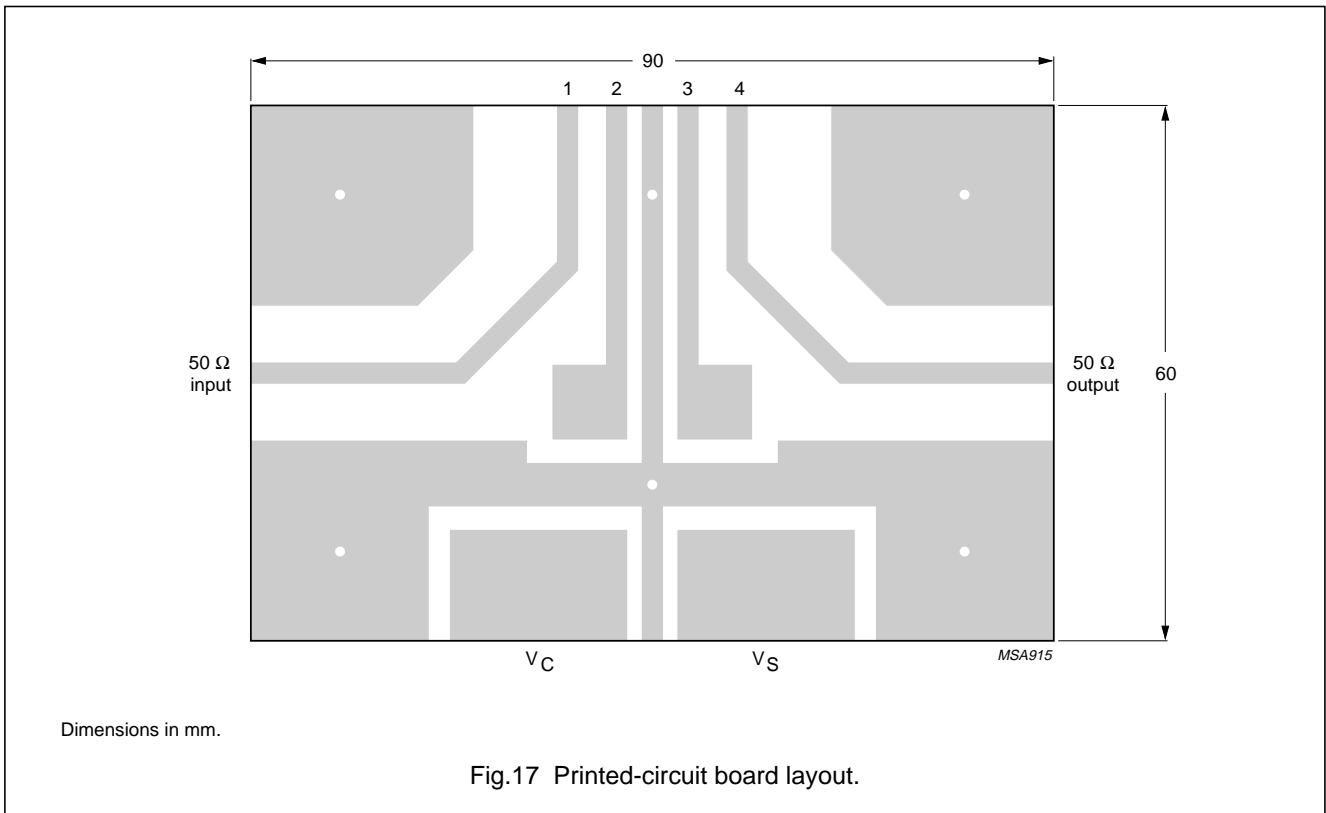

List of components (see Fig.16)

COMPONENT	DESCRIPTION	VALUE	DIMENSIONS	CATALOGUE NO.
C1, C2	multilayer ceramic chip capacitor	680 pF		2222 851 11681
C3	tantalum capacitor	2.2 μF; 35 V		–
C4	electrolytic capacitor	47 μF; 40 V		2222 030 37479
L1	Grade 4S2 Ferroxcube bead			4330 030 36300
Z ₁ , Z ₂	stripline; note 1	50 Ω	width = 2.33 mm	–
R1	metal film resistor	100 Ω; 0.6 W		2322 156 11001

Note

1. The striplines are on a double copper-clad printed-circuit board with PTFE fibreglass dielectric ($\epsilon_r = 2.2$); thickness $\frac{1}{32}$ inch.

UHF amplifier module

BGY205

SOLDERING

The indicated temperatures are those at the solder interfaces.

Advised solder types are types with a liquidus less than or equal to 210 °C.

Solder dots or solder prints must be large enough to wet the contact areas.

Footprints for soldering should cover the module contact area +0.1 mm on all sides.

Soldering can be carried out using a conveyor oven, a hot air oven, an infrared oven or a combination of these ovens.

Hand soldering must be avoided because the soldering iron tip can exceed the maximum permitted temperature of 250 °C and damage the module.

The maximum temperature profile and soldering time is indicated as follows (see Fig.18):

t = 350 s at 100 °C

t = 300 s at 125 °C

t = 200 s at 150 °C

t = 100 s at 175 °C

t = 50 s at 200 °C

t = 5 s at 250 °C (maximum temperature).

Cleaning

The following fluids may be used for cleaning:

- Alcohol
- Bio-Act (Terpene Hydrocarbon)
- Triclean B/S
- Acetone.

Ultrasonic cleaning should not be used since this can cause serious damage to the product.

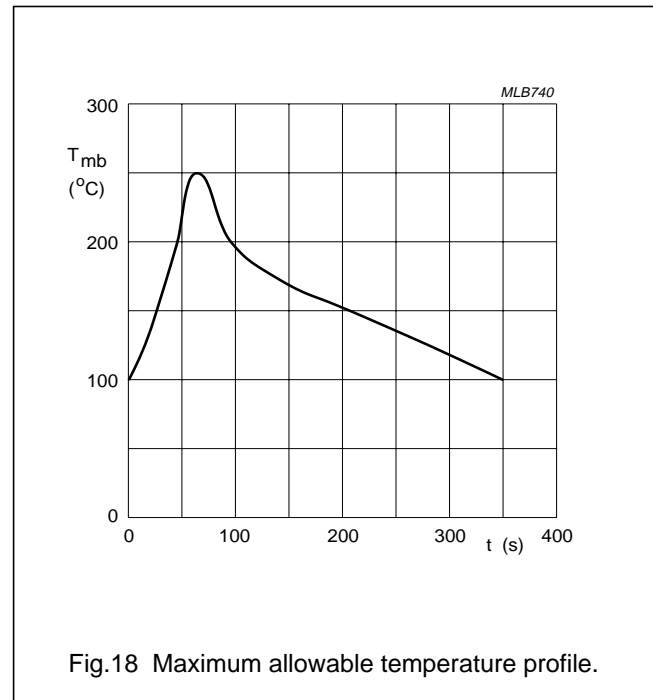
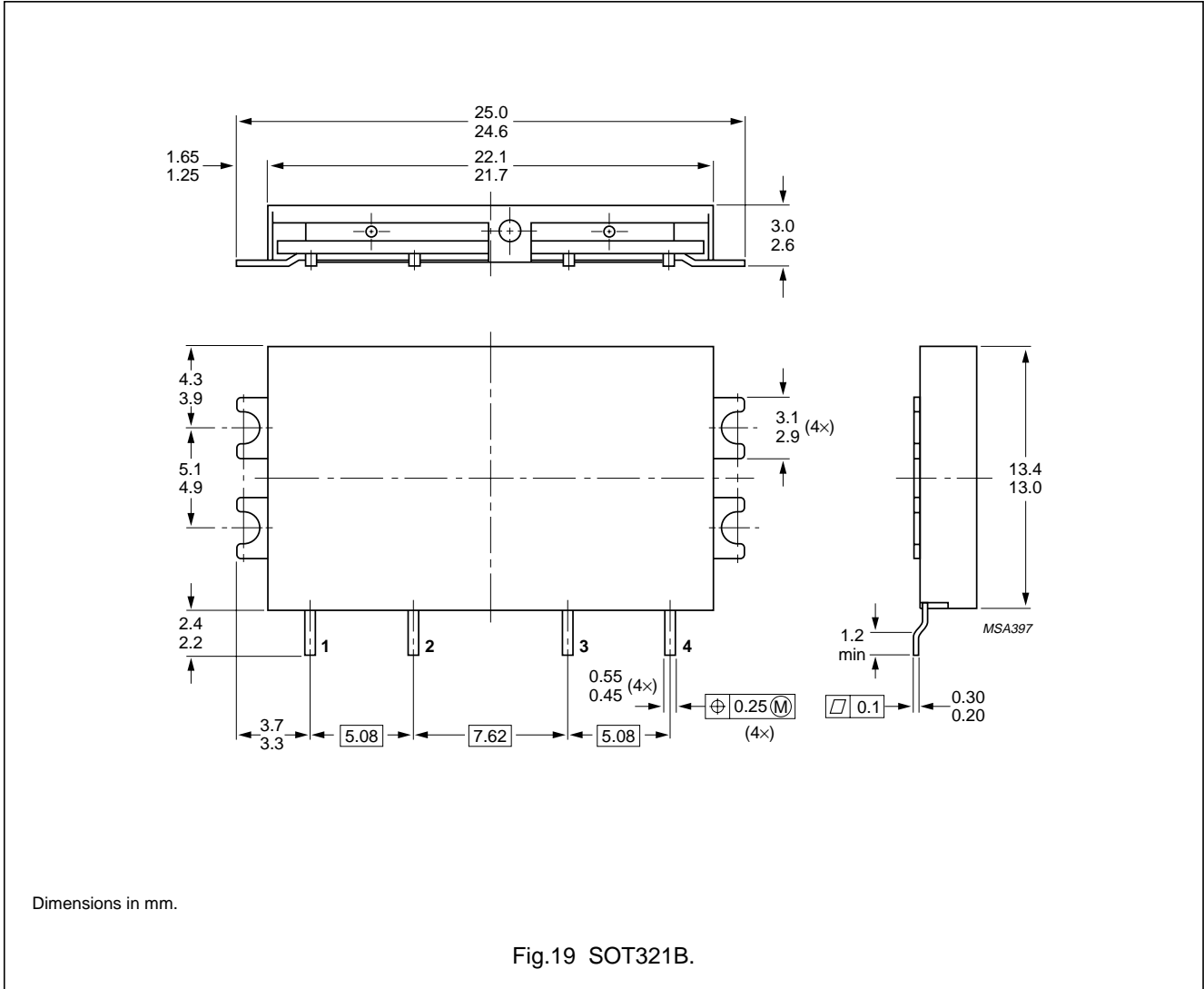

Fig.18 Maximum allowable temperature profile.

UHF amplifier module

BGY205

PACKAGE OUTLINE



UHF amplifier module

BGY205

DEFINITIONS

Data sheet status	
Objective specification	This data sheet contains target or goal specifications for product development.
Preliminary specification	This data sheet contains preliminary data; supplementary data may be published later.
Product specification	This data sheet contains final product specifications.
Limiting values	
Limiting values given are in accordance with the Absolute Maximum Rating System (IEC 134). Stress above one or more of the limiting values may cause permanent damage to the device. These are stress ratings only and operation of the device at these or at any other conditions above those given in the Characteristics sections of the specification is not implied. Exposure to limiting values for extended periods may affect device reliability.	
Application information	
Where application information is given, it is advisory and does not form part of the specification.	

LIFE SUPPORT APPLICATIONS

These products are not designed for use in life support appliances, devices, or systems where malfunction of these products can reasonably be expected to result in personal injury. Philips customers using or selling these products for use in such applications do so at their own risk and agree to fully indemnify Philips for any damages resulting from such improper use or sale.