

NOV 28 1990

Philips Components

Data sheet	
status	Product specification
date of issue	October 1990

BGY49A/BGY49B

UHF amplifier modules

DESCRIPTION

The BGY49A and BGY49B are UHF amplifier modules, primarily designed for mobile communications equipment operating from 12.5 V electrical systems.

The modules will produce a minimum output of 20 W into a 50 Ω load, over the frequency range 400 to 440 MHz (BGY49A) and 440 to 470 MHz (BGY49B).

QUICK REFERENCE DATA

TYPE NUMBER	MODE OF OPERATION	f (MHz)	P _L (W)	V _{S1} , V _{S2} (V)	G _P (dB)	η (%)	Z _i (Ω)	Z _L (Ω)
BGY49A	c.w.	400 - 440	> 20	typ. 12.5	> 21	> 35	typ. 50	typ. 50
BGY49B	c.w.	440 - 470	> 20	typ. 12.5	> 21	> 35	typ. 50	typ. 50

SC09

Philips Components



PHILIPS

UHF amplifier modules

BGY49A/BGY49B

MECHANICAL DATA

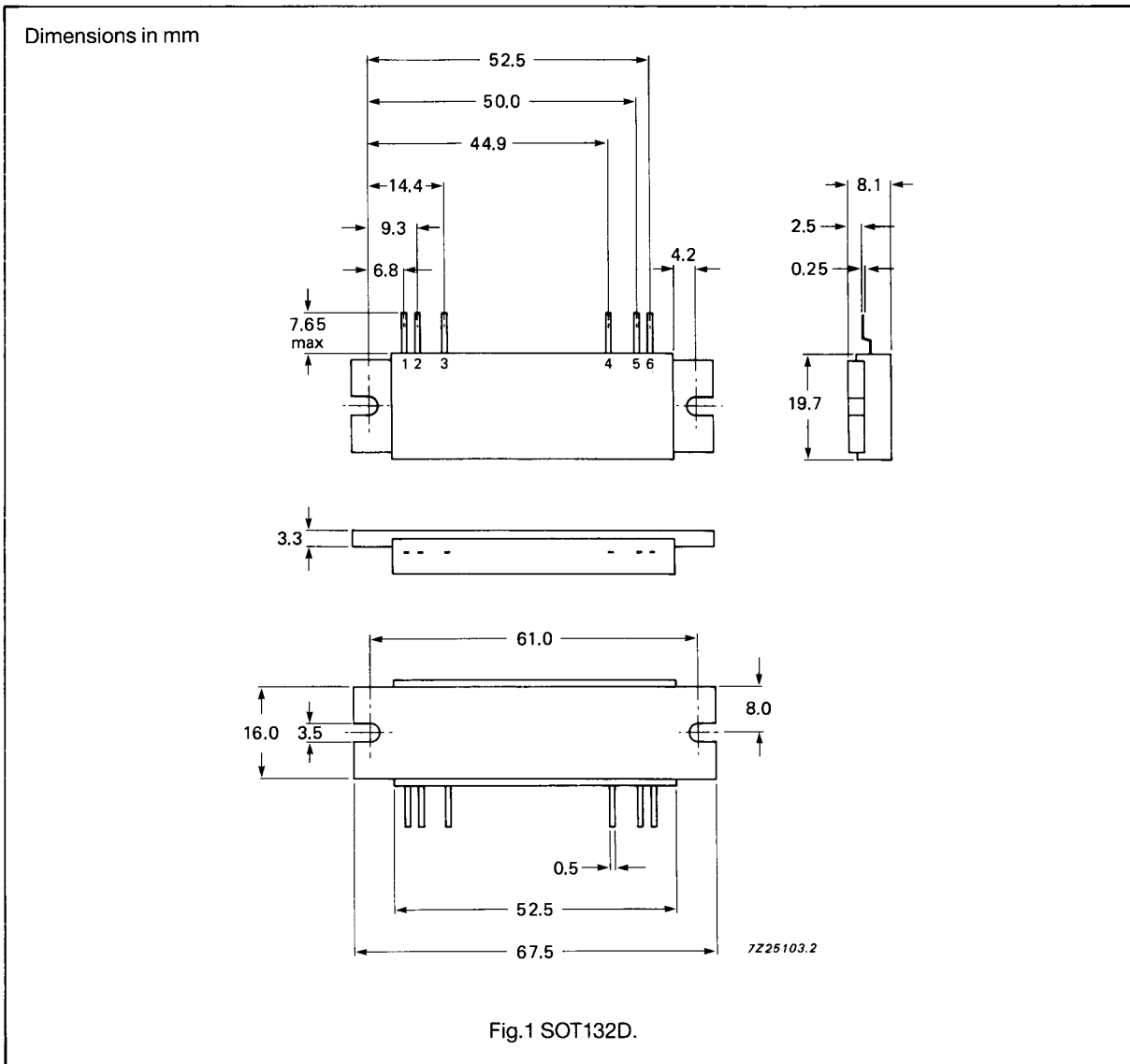

PINNING

LEAD	DESCRIPTION
1	RF input
2	ground
3	V _{S1}
4	V _{S2}
5	ground
6	RF output
flange	ground

UHF amplifier modules

BGY49A/BGY49B

LIMITING VALUES

In accordance with the Absolute Maximum System (IEC134)

SYMBOL	PARAMETER	MIN.	MAX.	UNIT
V_{S1}, V_{S2}	DC supply voltage	-	15.5	V
$\pm V_{IN}$	RF input terminal voltage	-	25	V
$+V_{OUT}$	RF output terminal voltage	-	25	V
P_L	RF output power see Fig.2	-	30	W
P_D	RF input power	-	300	mW
T_{stg}	storage temperature range	-30	+100	°C
T_h	operating heatsink temperature range	-30	+90	°C

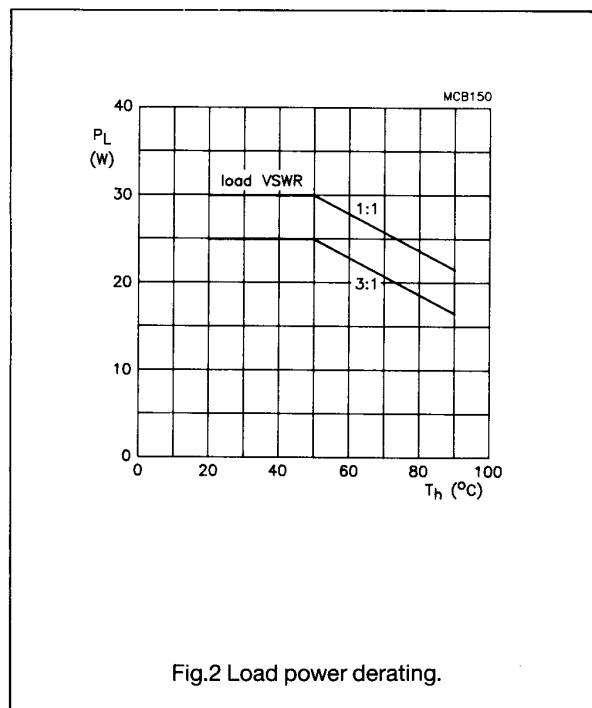

UHF amplifier modules**BGY49A/BGY49B****CHARACTERISTICS**

$T_h = 25\text{ }^\circ\text{C}$, $V_{S1} = V_{S2} = 12.5\text{ V}$, $R_S = R_L = 50\text{ }\Omega$.

SYMBOL	PARAMETER	CONDITIONS	MIN.	MAX.	UNIT
BW	frequency range BGY49A		400	440	MHz
BW	frequency range BGY49B		440	470	MHz
I_{Q1}	quiescent currents	$P_D = 0$	-	200	mA
P_D	RF input power	$P_L = 20\text{ W}$	-	150	mW
G_P	RF gain	$P_L = 20\text{ W}$	21	-	dB
η	efficiency	$P_L = 20\text{ W}$	35	-	%
H_{R2} , H_{R3}	harmonic output	$P_L = 20\text{ W}$	-	-40	dBC
	input VSWR with respect to $50\text{ }\Omega$	$P_L = 20\text{ W}$	-	2:1	

STABILITY

The module is stable when operated into a load of 4:1 at all phases, provided the operating conditions are within either of the following two sets:

- Control by P_D .

$P_L = 2\text{ mW}$ to 20 W .

$V_{S1} = V_{S2} = 10\text{ V}$ to 15.5 V .

P_D set for required P_L .

- Control by V_{S1} .

$P_L = 200\text{ mW}$ to 20 W .

$V_{S2} = 10\text{ V}$ to 15.5 V .

$P_D = 150\text{ mW}$ nominal.

V_{S1} set for required P_L .

OUTPUT POWER CONTROL

The module is designed to be operated over a wide range of output levels. The preferred method of output power control is to fix V_{S1} and V_{S2} at 12.5 V and vary the drive power. Another method of output power control is to fix V_{S2} at 12.5 V and the drive power at 150 mW , and vary V_{S1} , provided V_{S1} is not outside the stability criteria.

RUGGEDNESS

The module will withstand a load of 50:1 for short period overload conditions, with P_D , V_{S1} and V_{S2} at maximum values, providing the combination does not result in the matched RF output power derating curve being exceeded ($T_h < 90\text{ }^\circ\text{C}$).

UHF amplifier modules

BGY49A/BGY49B

APPLICATION INFORMATION

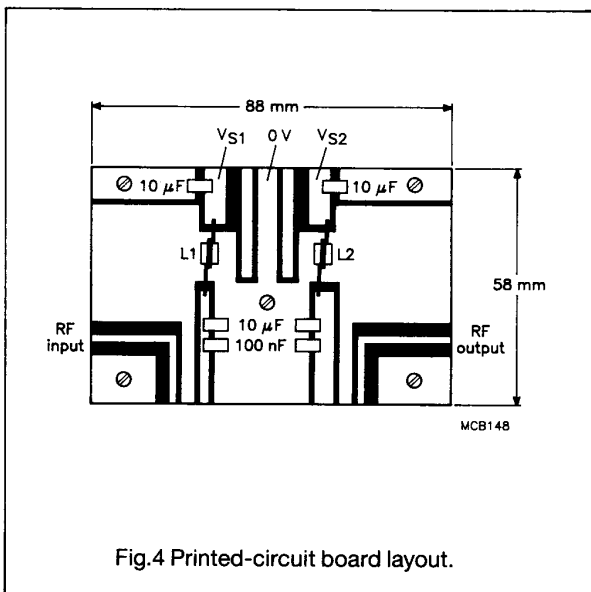
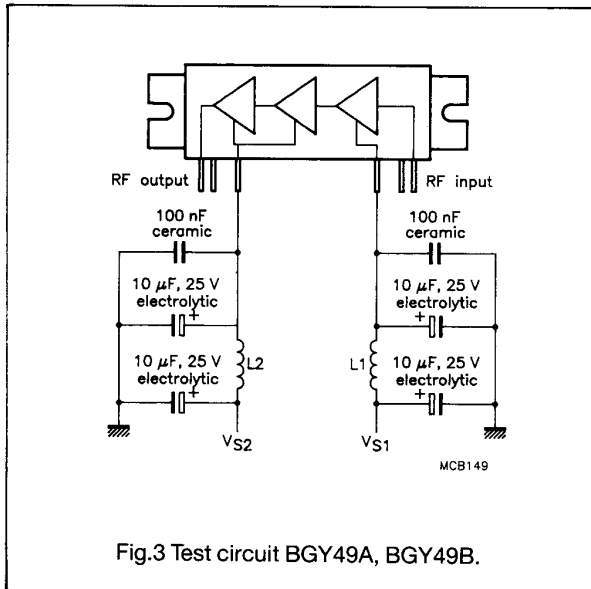

Notes

1. L1 and L2 chokes are 2.5 turns 22 SWG copper wire on an FX1115 former.
2. The printed-circuit board is 1/6 inch thick epoxy fibre-glass, $\epsilon_r = 4.5$.

UHF amplifier modules

BGY49A/BGY49B

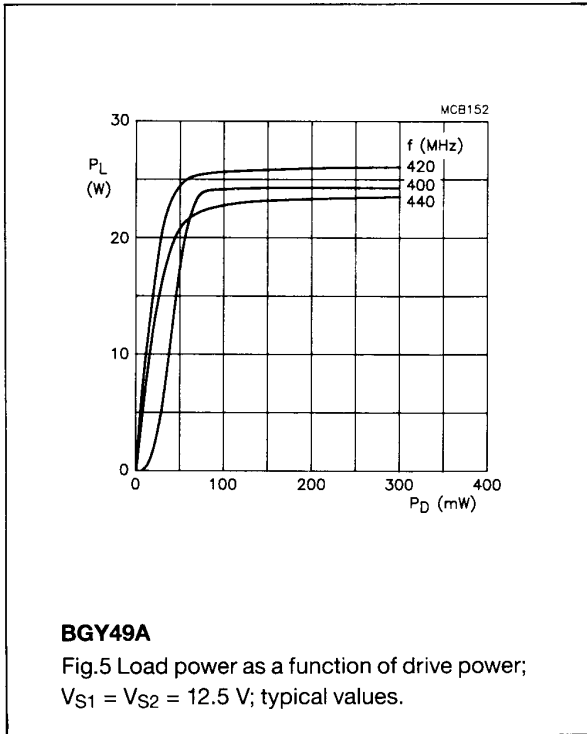

BGY49A
Fig.5 Load power as a function of drive power;
 $V_{S1} = V_{S2} = 12.5$ V; typical values.

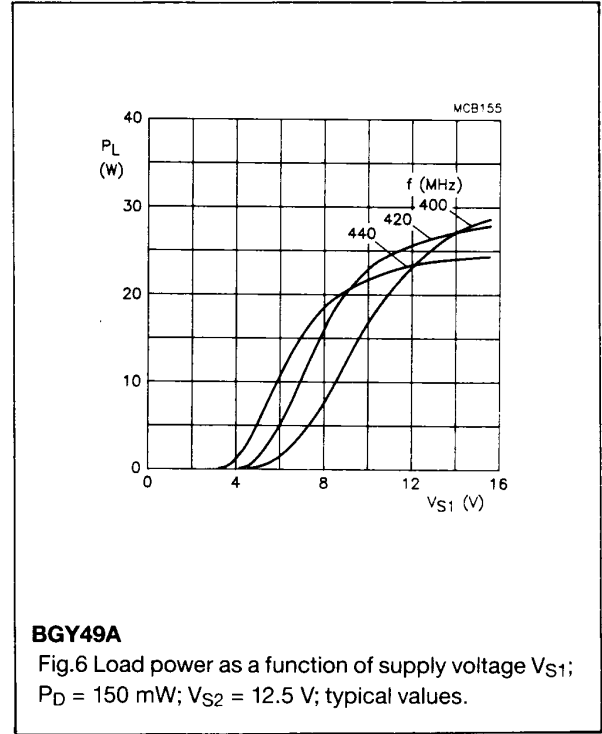

BGY49A
Fig.6 Load power as a function of supply voltage V_{S1} ;
 $P_D = 150$ mW; $V_{S2} = 12.5$ V; typical values.

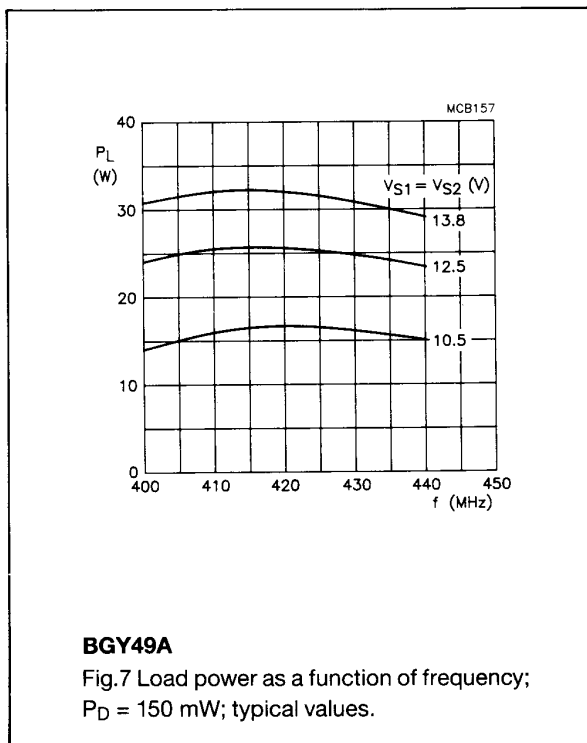

BGY49A
Fig.7 Load power as a function of frequency;
 $P_D = 150$ mW; typical values.

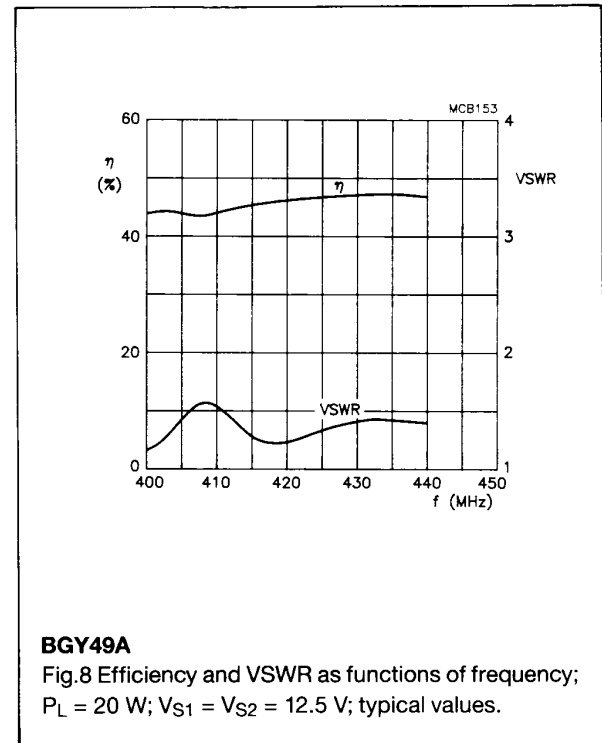

BGY49A
Fig.8 Efficiency and VSWR as functions of frequency;
 $P_L = 20$ W; $V_{S1} = V_{S2} = 12.5$ V; typical values.

UHF amplifier modules

BGY49A/BGY49B

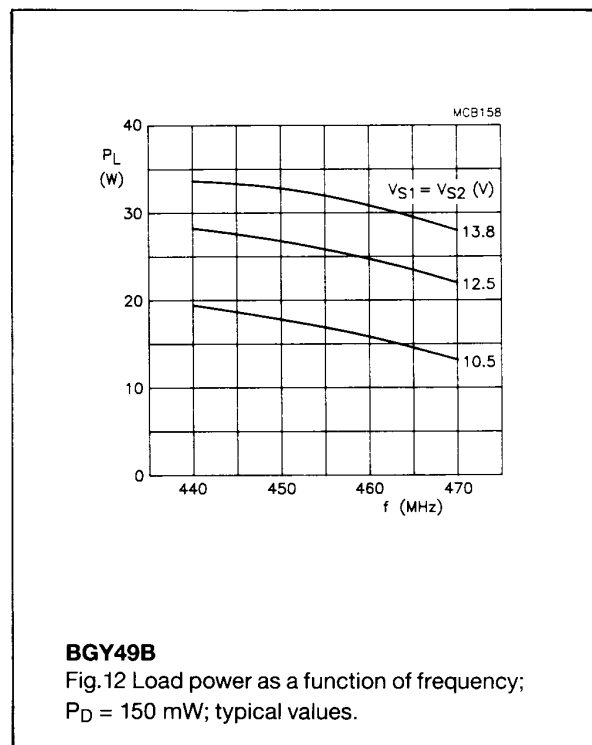
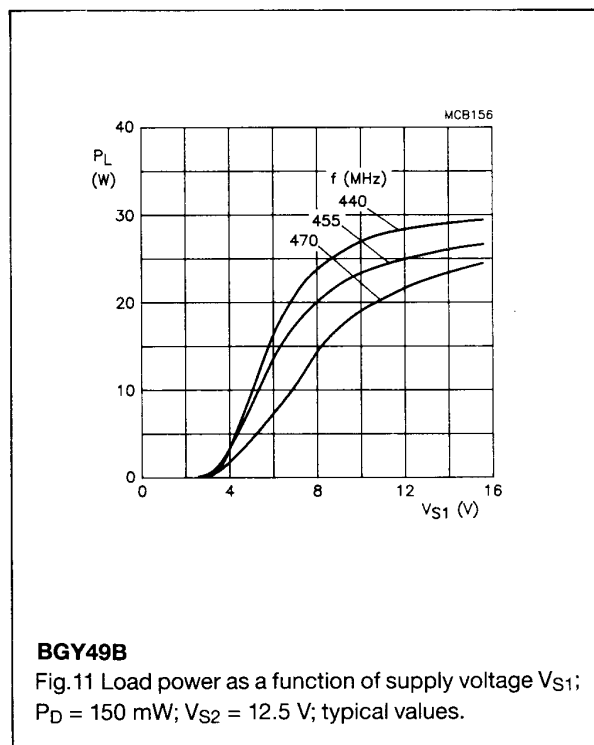
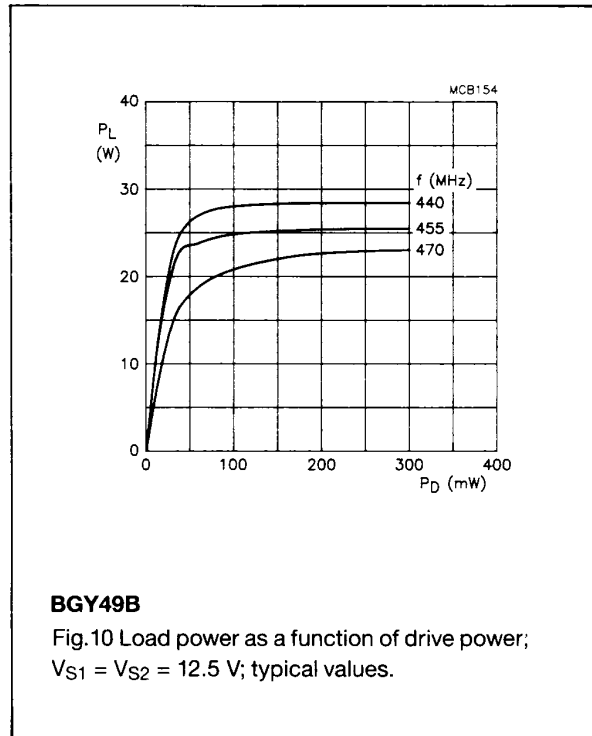
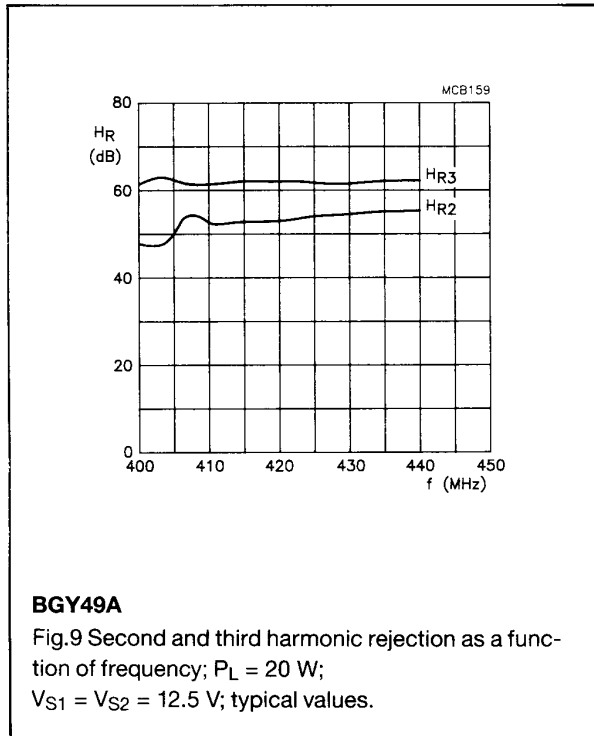

UHF amplifier modules

BGY49A/BGY49B

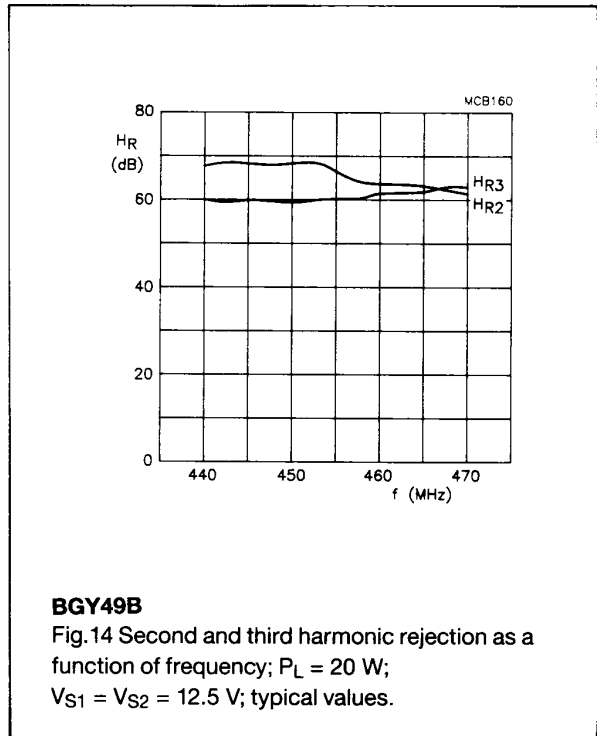
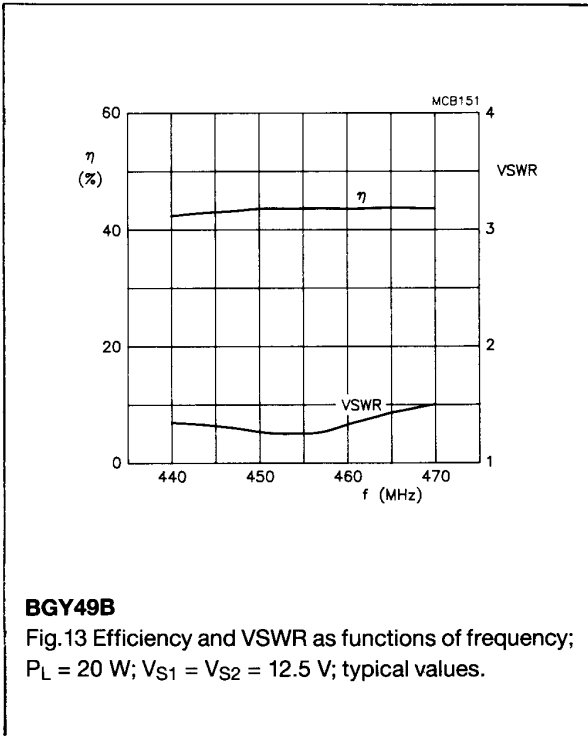

UHF amplifier modules**BGY49A/BGY49B****DEFINITIONS**

Data sheet status	
Objective specification	This data sheet contains target or goal specifications for product development.
Preliminary specification	This data sheet contains preliminary data; supplementary data may be published later.
Product specification	This data sheet contains final product specifications.
Limiting values	
Limiting values given are in accordance with the Absolute Maximum Rating System (IEC 134). Stress above one or more of the limiting values may cause permanent damage to the device. These are stress ratings only and operation of the device at these or at any other conditions above those given in the Characteristics sections of this specification is not implied. Exposure to limiting values for extended periods may affect device reliability.	
© Philips Export B.V. 1990	
All rights are reserved. Reproduction in whole or in part is prohibited without the prior written consent of the copyright owner.	
The information presented in this document does not form part of any quotation or contract, is believed to be accurate and reliable and may be changed without notice. No liability will be accepted by the publisher for any consequence of its use. Publication thereof does not convey nor imply any license under patent- or other industrial or intellectual property rights.	

Printed in The Netherlands

9397 287 60011