

DATA SHEET

BLU97 UHF power transistor

Product specification

August 1986

UHF power transistor

BLU97

DESCRIPTION

N-P-N silicon planar epitaxial transistor designed for use in mobile radio transmitters in the 470 MHz band.

FEATURES

- multi-base structure and emitter-ballasting resistors for an optimum temperature profile.
- gold metallization ensures excellent reliability.

The transistor has a 4-lead stud envelope with a ceramic cap (SOT122A). All leads are isolated from the stud.

QUICK REFERENCE DATA

R.F. performance up to $T_h = 25\text{ }^\circ\text{C}$ in a common-emitter class-B circuit

MODE OF OPERATION	V_{CE} V	f MHz	P_L W	G_p dB	η_c %
narrow band; c.w.	12,5	470	7	> 8,5	> 55

PIN CONFIGURATION

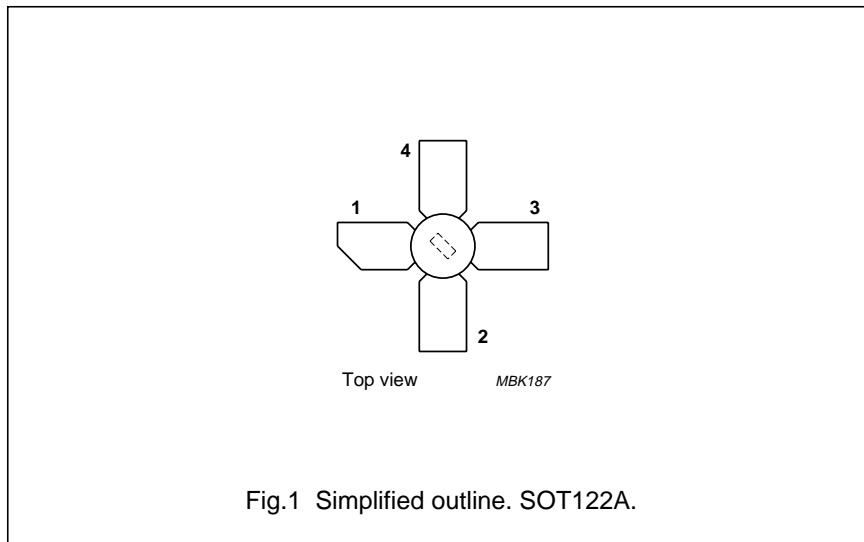

PINNING - SOT122A.

PIN	DESCRIPTION
1	collector
2	emitter
3	base
4	emitter

PRODUCT SAFETY This device incorporates beryllium oxide, the dust of which is toxic. The device is entirely safe provided that the BeO disc is not damaged.

UHF power transistor

BLU97

RATINGS

Limiting values in accordance with the Absolute Maximum System (IEC 134)

Collector-base voltage (open emitter)	V_{CBO}	max.	36 V
Collector-emitter voltage (open base)	V_{CEO}	max.	16 V
Emitter-base voltage (open collector)	V_{EBO}	max.	3 V
Collector current			
d.c. or average	I_C	max.	1,2 A
(peak value); $f > 1$ MHz	I_{CM}	max.	3,6 A
Total power dissipation			
at $T_{mb} = 52$ °C	$P_{tot(d.c.)}$	max.	17 W
$f > 1$ MHz; $T_{mb} = 52$ °C	$P_{tot(r.f.)}$	max.	22,5 W
Storage temperature	T_{stg}		-65 to +150 °C
Operating junction temperature	T_j	max.	200 °C

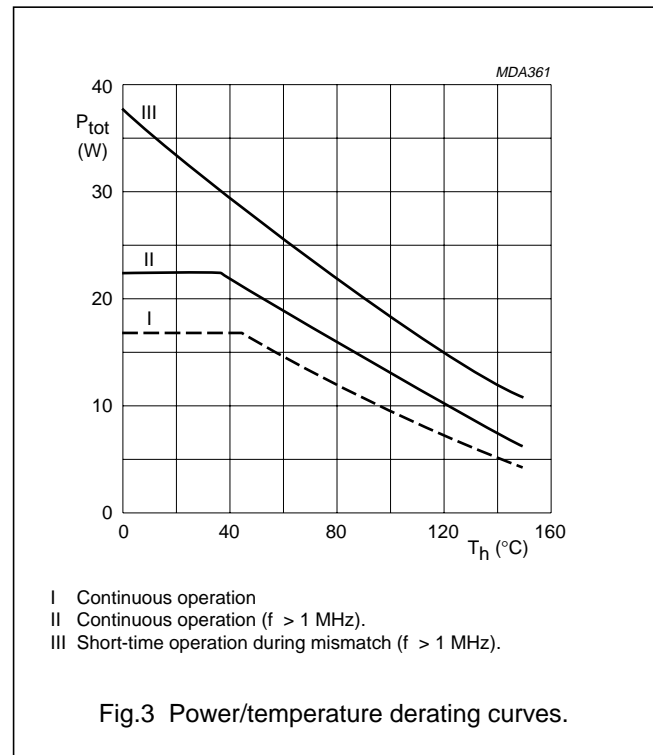
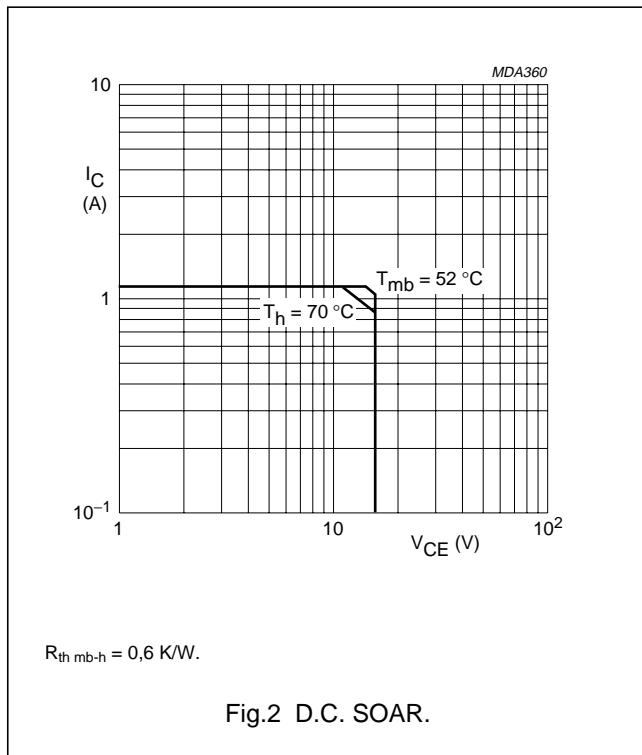

THERMAL RESISTANCE

Dissipation = 15 W; $T_{mb} = 25$ °C

From junction to mounting base

(d.c. dissipation)

(r.f. dissipation)

From mounting base to heatsink

$R_{th j-mb(dc)}$ = 7,5 K/W

$R_{th j-mb(rf)}$ = 5,6 K/W

$R_{th mb-h}$ = 0.6 K/W

UHF power transistor

BLU97

CHARACTERISTICS

$T_j = 25\text{ }^\circ\text{C}$ unless otherwise specified

Collector-base breakdown voltage, open emitter; $I_C = 15\text{ mA}$

Collector-emitter breakdown voltage, open base; $I_C = 30\text{ mA}$

Emitter-base breakdown voltage, open collector; $I_E = 1,5\text{ mA}$

Collector cut-off current, $V_{BE} = 0$; $V_{CE} = 16\text{ V}$

Second breakdown energy, $L = 25\text{ mH}$; $f = 50\text{ Hz}$; $R_{BE} = 10\text{ }\Omega$

D.C. current gain, $I_C = 0,9\text{ A}$; $V_{CE} = 10\text{ V}$

Transition frequency at $f = 500\text{ MHz}^{(1)}$, $-I_E = 0,9\text{ A}$; $V_{CB} = 12,5\text{ V}$

Collector capacitance at $f = 1\text{ MHz}$, $I_E = i_e = 0$; $V_{CB} = 12,5\text{ V}$

Feed-back capacitance at $f = 1\text{ MHz}$, $I_C = 0$; $V_{CE} = 12,5\text{ V}$

Collector-stud capacitance

$V_{(BR)CBO}$	>	36 V
$V_{(BR)CEO}$	>	16 V
$V_{(BR)EBO}$	>	3 V
I_{CES}	<	7,5 mA
E_{SBR}	>	2,3 mJ
h_{FE}	>	25
	typ.	100
f_T	typ.	4,0 GHz
C_C	typ.	10 pF
C_{re}	typ.	7 pF
C_{CS}	typ.	1,2 pF

Note

1. Measured under pulse conditions: $t_p = 50\text{ }\mu\text{s}$; $\delta < 1\%$.

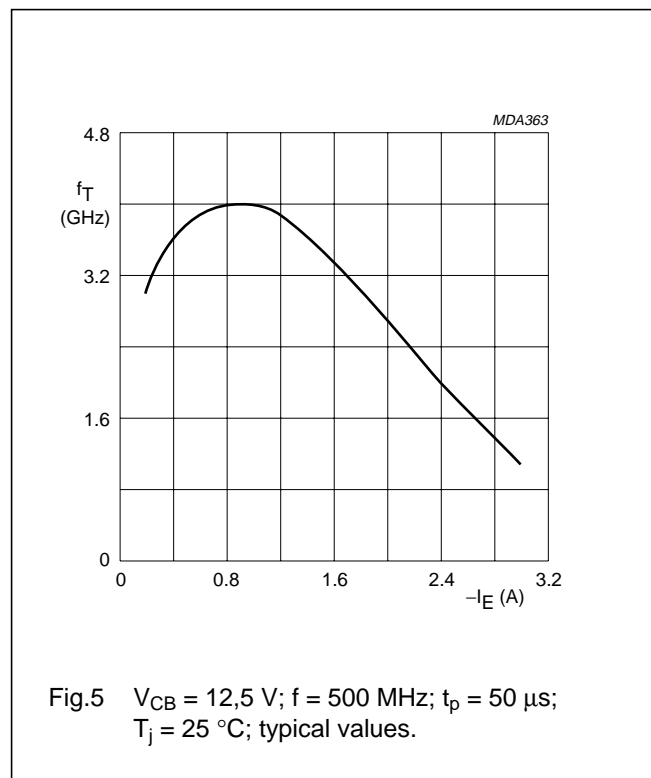
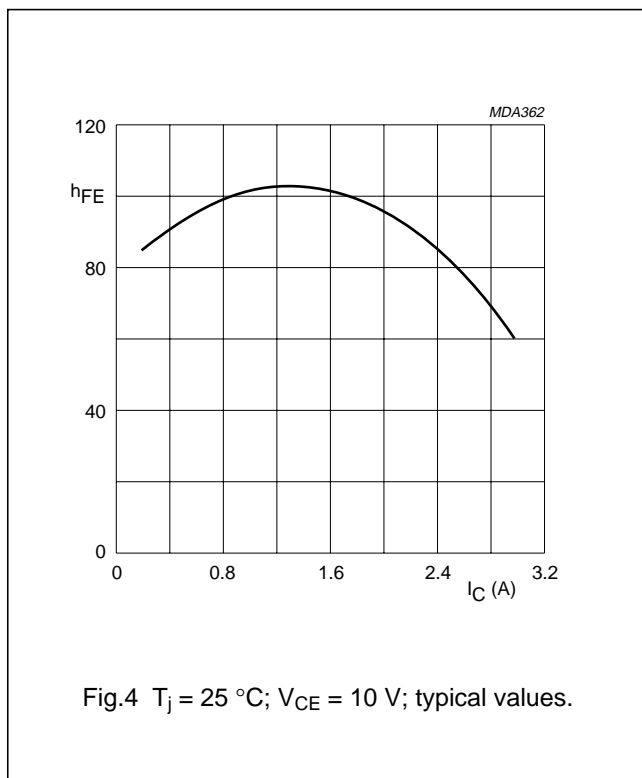

UHF power transistor

BLU97

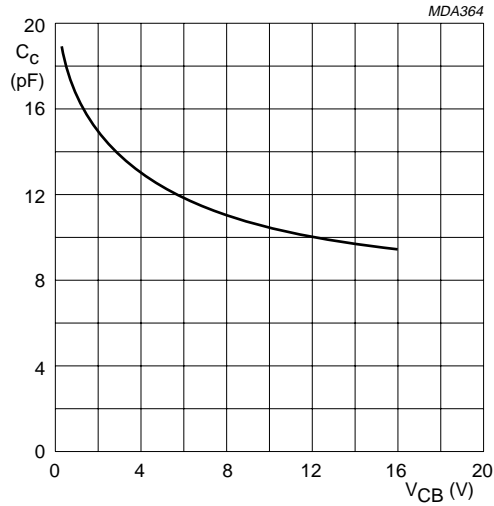

Fig.6 I_E = i_e = 0; f = 1 MHz; typical values.

APPLICATION INFORMATION

R.F. performance in common-emitter circuit; class-B: f = 470 MHz; T_h = 25 °C

MODE OF OPERATION	V _{CE} V	P _L W	P _S W	G _p dB	I _C A	η _c %
narrow band; c.w.	12,5	7	< 0,99 typ. 0,55	> 8,5 typ. 11,0	< 1,0 typ. 0,8	> 55 typ. 70

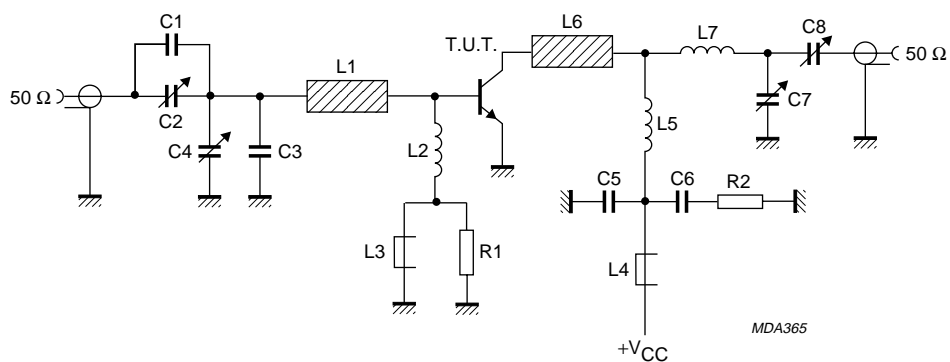

Fig.7 Class-B test circuit at f = 470 MHz.

UHF power transistor**BLU97**

List of components:

- C1 = 2,7 pF multilayer ceramic chip capacitor⁽¹⁾
C2 = C7 = C8 = 1,4 to 5,5 pF film dielectric trimmer (cat. no. 2222 809 09001)
C3 = 7,5 pF multilayer ceramic chip capacitor⁽¹⁾
C4 = 2 to 9 pF film dielectric trimmer (cat. no. 2222 809 09002)
C5 = 100 pF multilayer ceramic chip capacitor
C6 = 100 nF metallized film capacitor
L1 = 38 Ω stripline (22,5 mm \times 6,0 mm)
L2 = 15 nH; 1 turn Cu wire (1,0 mm); int. dia. 5 mm; leads 2 \times 5 mm
L3 = L4 = Ferroxcube wideband h.f. choke, grade 3B (cat. no. 4312 020 36642)
L5 = 29 nH; 2 turns enamelled Cu wire (1,0 mm); int. dia. 6 mm; length 3,5 mm; leads 2 \times 5 mm
L6 = 38 Ω stripline (10,0 mm \times 6,0 mm)
L7 = 7 nH; 1/2 turn Cu wire (1,0 mm); int. dia. 5,0 mm; leads 2 \times 5 mm
R1 = R2 = 10 $\Omega \pm 10\%$; 0,25 W metal film resistor
L1 and L6 are striplines on a double Cu-clad printed circuit board with P.T.F.E. fibre-glass dielectric ($\epsilon_r = 2,74$); thickness $\frac{1}{16}$ inch.

Note

1. American Technical Ceramics capacitor type 100A or capacitor of same quality.

UHF power transistor

BLU97

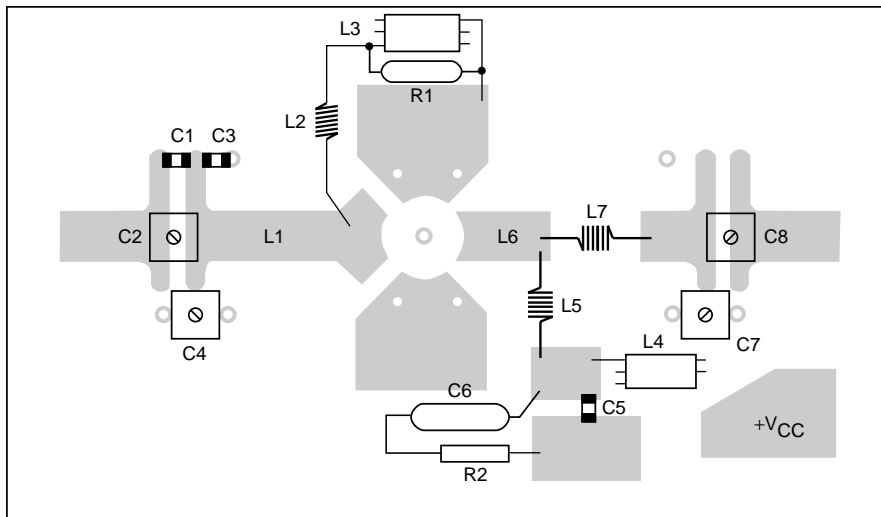
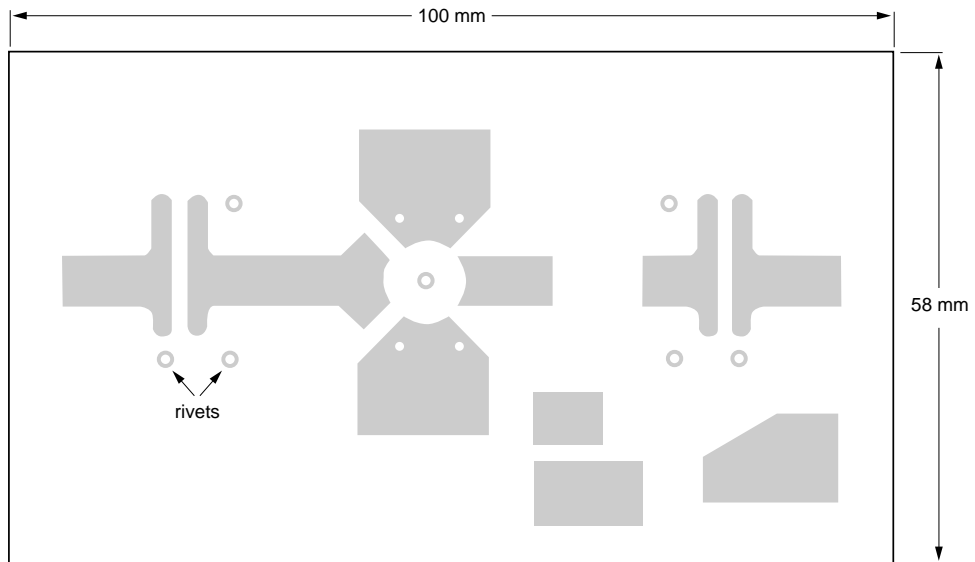

MDA366

The circuit and the components are on one side of the P.T.F.E. fibre-glass board; the other side is unetched copper serving as ground plane. Earth connections are made by hollow rivets and also by copper straps under the emitters.

Fig.8 Printed circuit board and component lay-out for 470 MHz class-B test circuit.

UHF power transistor

BLU97

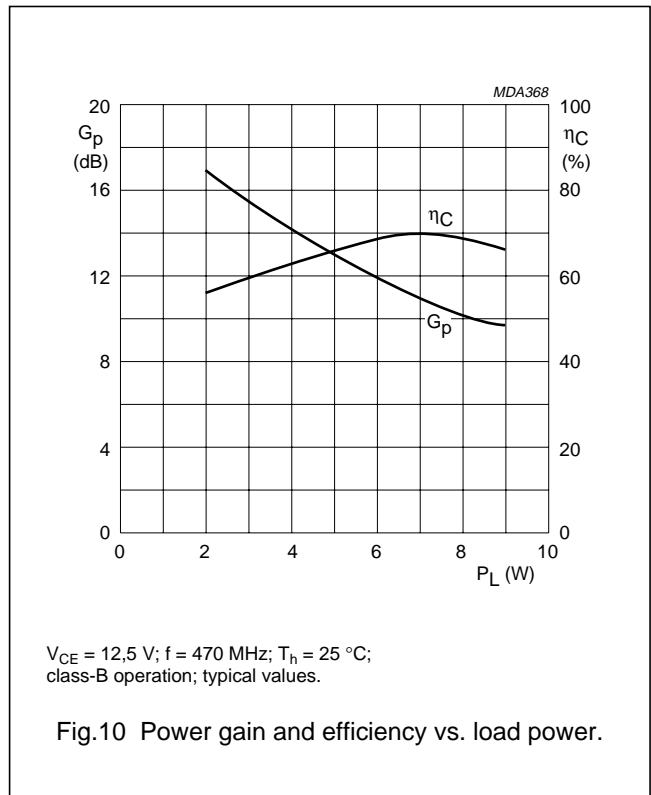
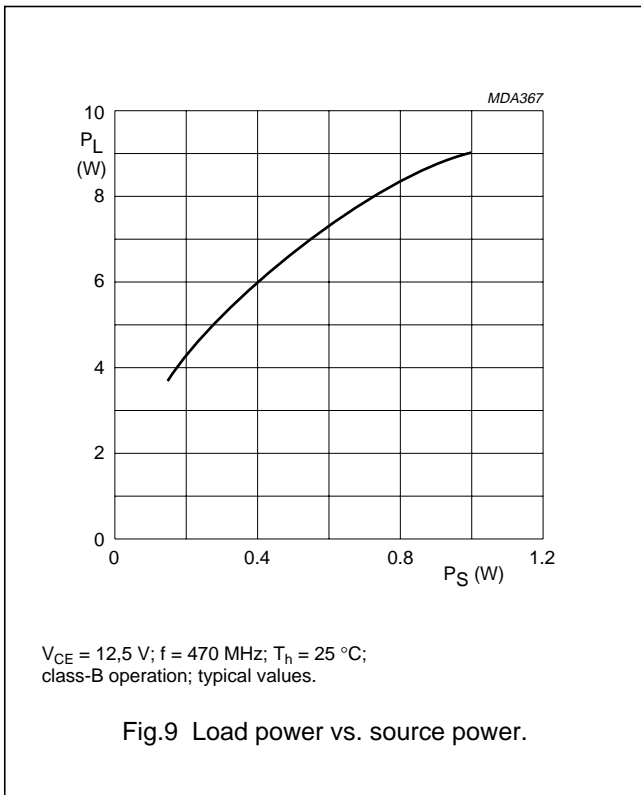

RUGGEDNESS

The device is capable of withstanding a full load mismatch (VSWR = 50; all phases) at rated load power up to a supply voltage of 15,5 V and $T_h = 25$ °C.

UHF power transistor

BLU97

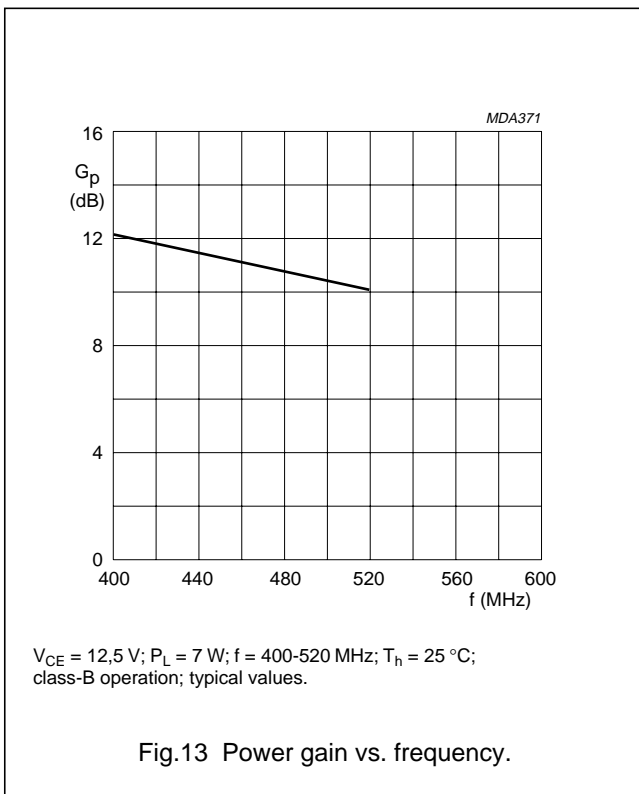
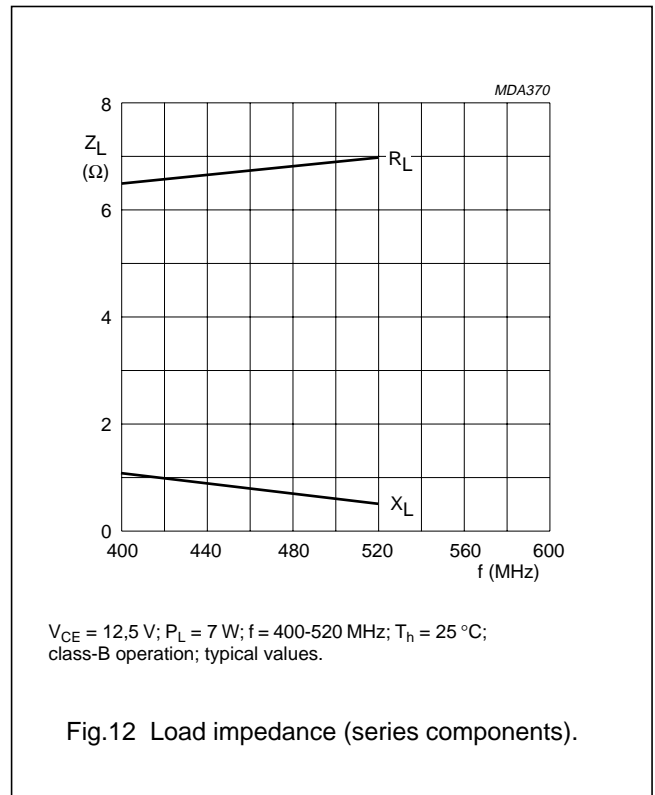
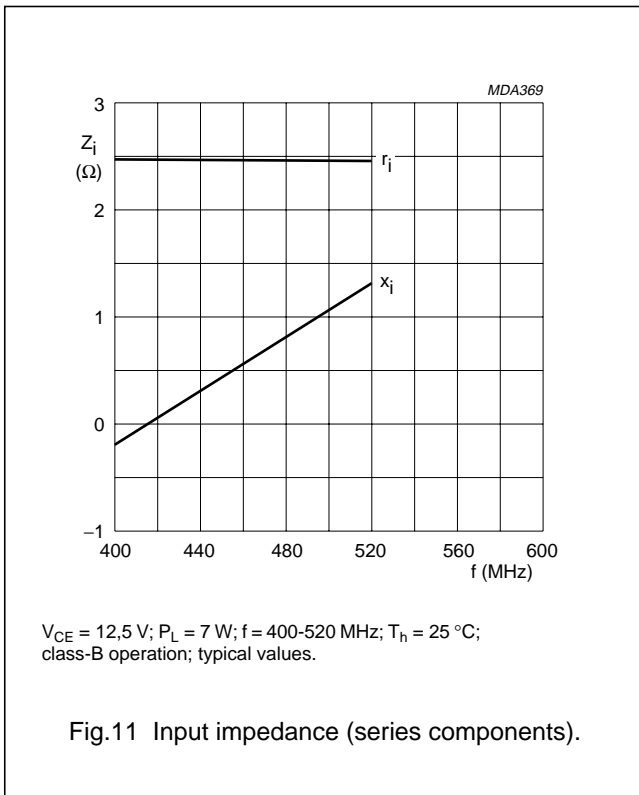

UHF power transistor

BLU97

PACKAGE OUTLINE

Studded ceramic package; 4 leads

SOT122A

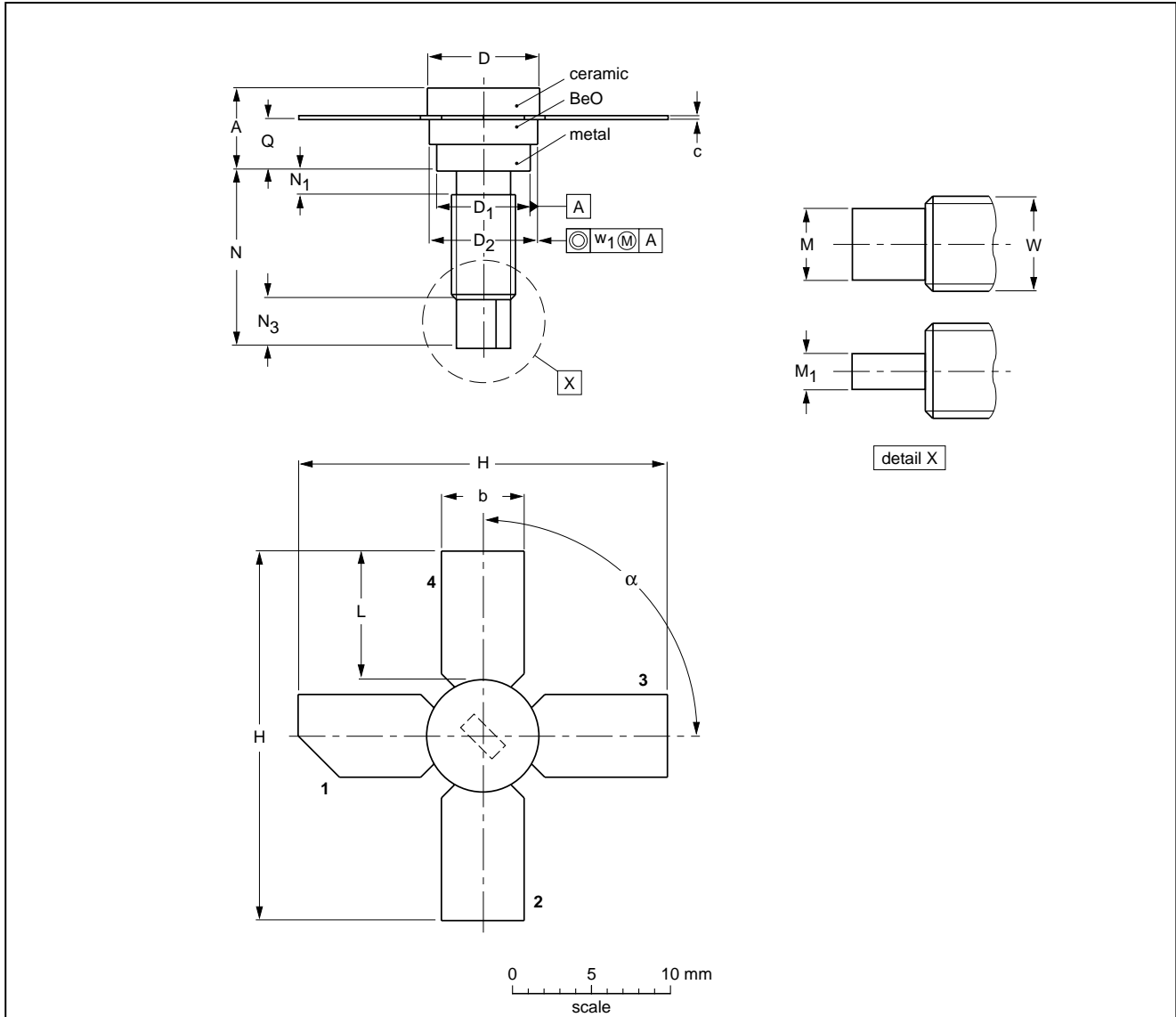

DIMENSIONS (millimetre dimensions are derived from the original inch dimensions)

UNIT	A	b	c	D	D ₁	D ₂	H	L	M ₁	M	N	N ₁ max.	N ₃	Q	W	w ₁	α
mm	5.97 4.74	5.85 5.58	0.18 0.14	7.50 7.23	6.48 6.22	7.24 6.93	27.56 25.78	9.91 9.14	3.18 2.66	1.66 1.39	11.82 11.04	1.02	3.86 2.92	3.38 2.74	8-32 UNC	0.381	90°

OUTLINE VERSION	REFERENCES				EUROPEAN PROJECTION	ISSUE DATE
	IEC	JEDEC	EIAJ			
SOT122A						97-04-18

UHF power transistor

BLU97

DEFINITIONS

Data Sheet Status	
Objective specification	This data sheet contains target or goal specifications for product development.
Preliminary specification	This data sheet contains preliminary data; supplementary data may be published later.
Product specification	This data sheet contains final product specifications.
Limiting values	
Limiting values given are in accordance with the Absolute Maximum Rating System (IEC 134). Stress above one or more of the limiting values may cause permanent damage to the device. These are stress ratings only and operation of the device at these or at any other conditions above those given in the Characteristics sections of the specification is not implied. Exposure to limiting values for extended periods may affect device reliability.	
Application information	
Where application information is given, it is advisory and does not form part of the specification.	

LIFE SUPPORT APPLICATIONS

These products are not designed for use in life support appliances, devices, or systems where malfunction of these products can reasonably be expected to result in personal injury. Philips customers using or selling these products for use in such applications do so at their own risk and agree to fully indemnify Philips for any damages resulting from such improper use or sale.