

DATA SHEET

BLV193 UHF power transistor

Product specification

March 1993

UHF power transistor

BLV193

FEATURES

- Emitter ballasting resistors for an optimum temperature profile
- Gold metallization ensures excellent reliability.

DESCRIPTION

NPN silicon planar epitaxial transistor intended for common emitter class-A and class-AB operation in the 900 MHz communications band.

The transistor has a SOT171 flange envelope with a ceramic cap. All leads are isolated from the mounting base.

PINNING - SOT171

PIN	DESCRIPTION
1	emitter
2	emitter
3	base
4	collector
5	emitter
6	emitter

QUICK REFERENCE DATA

RF performance at $T_h = 25\text{ }^\circ\text{C}$ in a common emitter test circuit.

MODE OF OPERATION	f (MHz)	V _{CE} (V)	P _L (W)	G _p (dB)	η_c (%)	d _{im} (dB) (note 1)
c.w. class-AB	900	12.5	12	≥ 6.5	≥ 50	–
c.w. class-A	900	12	6 (PEP)	typ. 11	–	typ. –30

Note

1. 2-tone measurement, $f_p = 900\text{ MHz}$, $f_q = 901\text{ MHz}$.

PIN CONFIGURATION

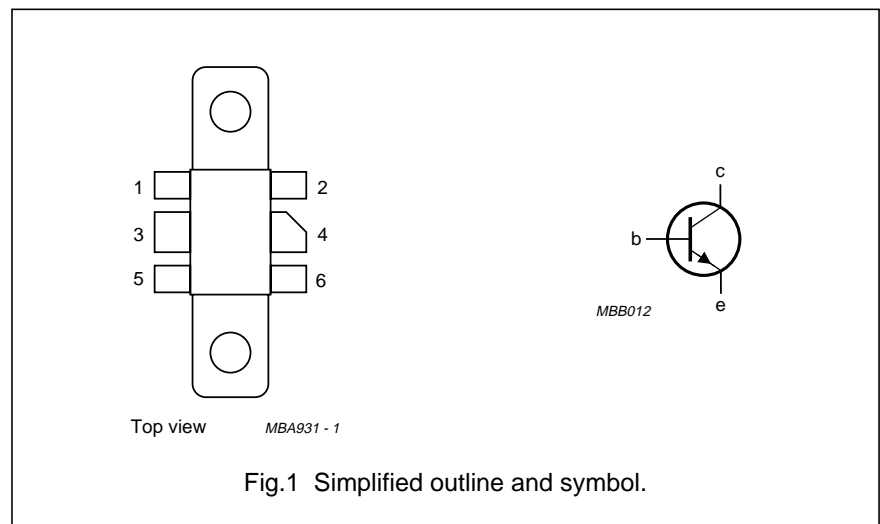

WARNING

Product and environmental safety - toxic materials

This product contains beryllium oxide. The product is entirely safe provided that the BeO disc is not damaged. All persons who handle, use or dispose of this product should be aware of its nature and of the necessary safety precautions. After use, dispose of as chemical or special waste according to the regulations applying at the location of the user. It must never be thrown out with the general or domestic waste.

UHF power transistor

BLV193

LIMITING VALUES

In accordance with the Absolute Maximum System (IEC 134).

SYMBOL	PARAMETER	CONDITIONS	MIN.	MAX.	UNIT
V_{CBO}	collector-base voltage	open emitter	–	36	V
V_{CEO}	collector-emitter voltage	open base	–	16	V
V_{EBO}	emitter-base voltage	open collector	–	3	V
I_C	collector current	DC or average value	–	3.5	A
P_{tot}	total power dissipation	up to $T_{mb} = 25\text{ °C}$	–	44	W
T_{stg}	storage temperature range		–65	150	°C
T_j	junction temperature		–	200	°C

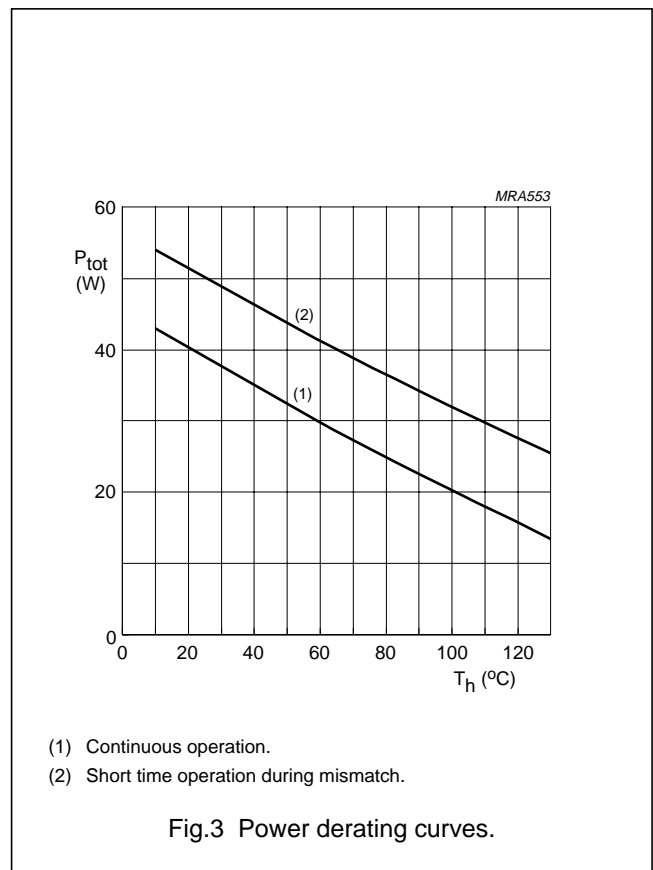
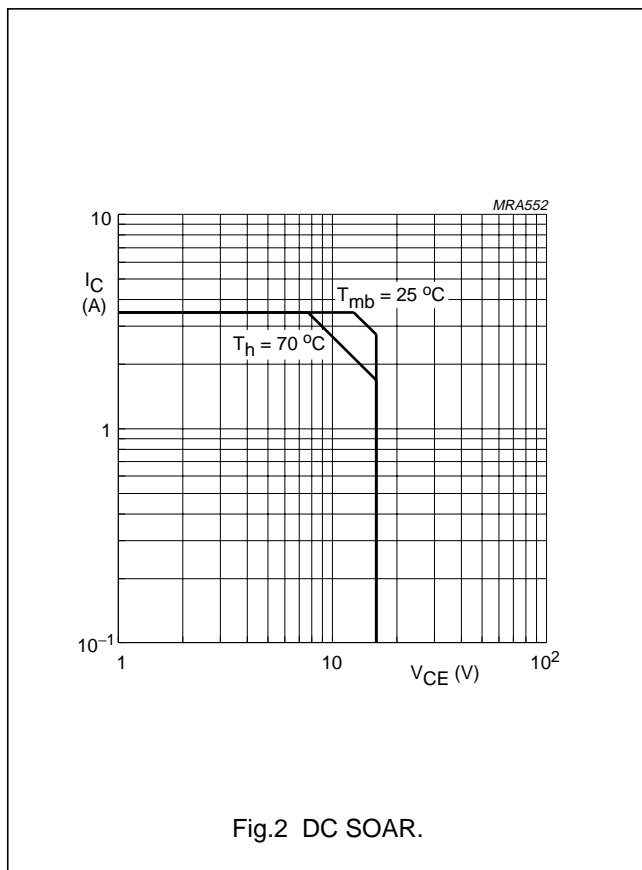

THERMAL RESISTANCE

SYMBOL	PARAMETER	CONDITIONS	THERMAL RESISTANCE
$R_{th\ j-mb}$	from junction to mounting base	$P_{dis} = 44\text{ W}; T_{mb} = 25\text{ °C}$	4.0 K/W
$R_{th\ mb-h}$	from mounting base to heatsink		0.4 K/W

UHF power transistor

BLV193

CHARACTERISTICS $T_j = 25\text{ }^\circ\text{C}$ unless otherwise specified.

SYMBOL	PARAMETER	CONDITIONS	MIN.	TYP.	MAX.	UNIT
$V_{(BR)CBO}$	collector-base breakdown voltage	open emitter; $I_c = 20\text{ mA}$	36	–	–	V
$V_{(BR)CEO}$	collector-emitter breakdown voltage	open base; $I_c = 40\text{ mA}$	16	–	–	V
$V_{(BR)EBO}$	emitter-base breakdown voltage	open collector; $I_E = 0.5\text{ mA}$	3	–	–	V
I_{CES}	collector-emitter leakage current	$V_{CE} = 16\text{ V};$ $V_{BE} = 0$	–	–	1	mA
h_{FE}	DC current gain	$V_{CE} = 10\text{ V};$ $I_c = 1.2\text{ A};$ note 1	25	60	–	
C_c	collector capacitance	$V_{CB} = 12.5\text{ V};$ $I_E = I_e = 0;$ $f = 1\text{ MHz}$	–	24.5	–	pF
C_{re}	feedback capacitance	$V_{CE} = 12.5\text{ V};$ $I_c = 0;$ $f = 1\text{ MHz}$	–	13	–	pF
C_{c-mb}	collector-mounting base capacitance		–	2	–	pF

Note

1. Measured under pulse conditions: $t_p \leq 200\text{ }\mu\text{s}; \delta \leq 0.02$.

UHF power transistor

BLV193

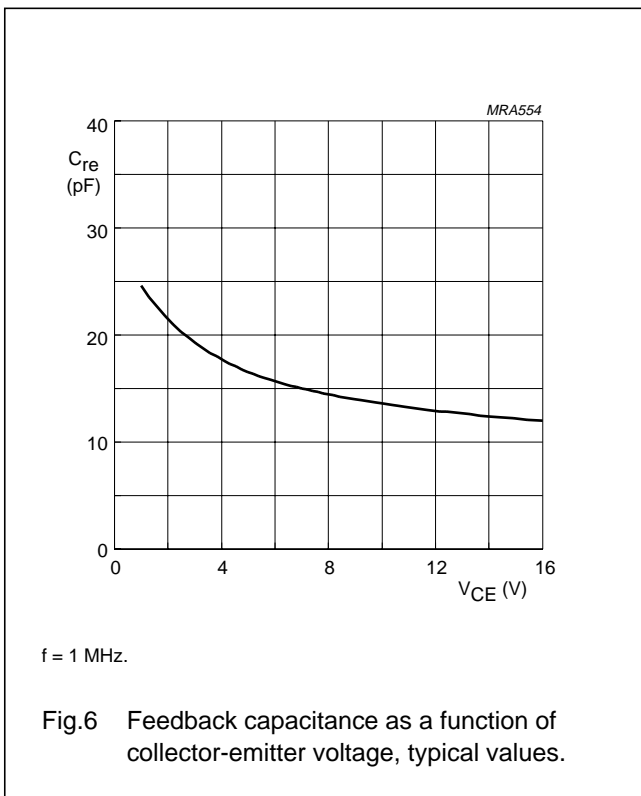
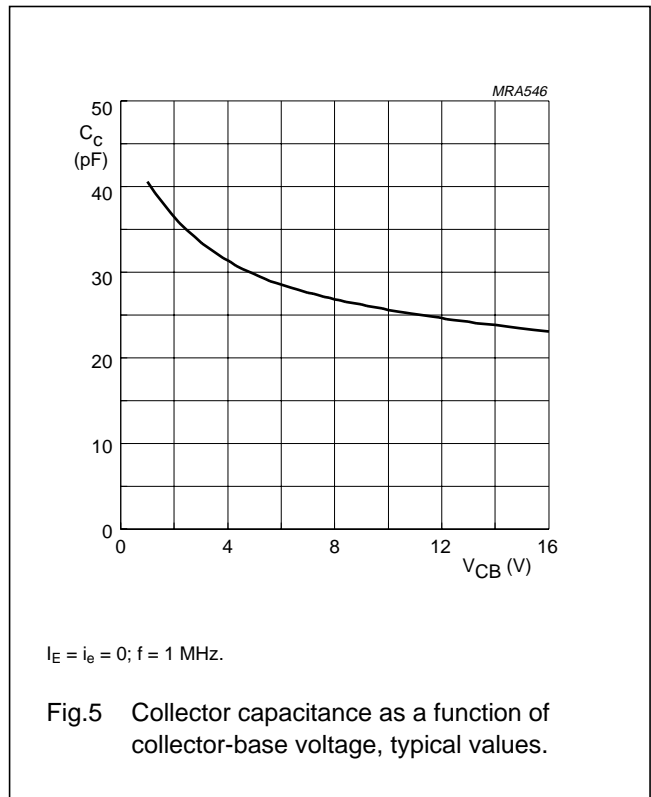
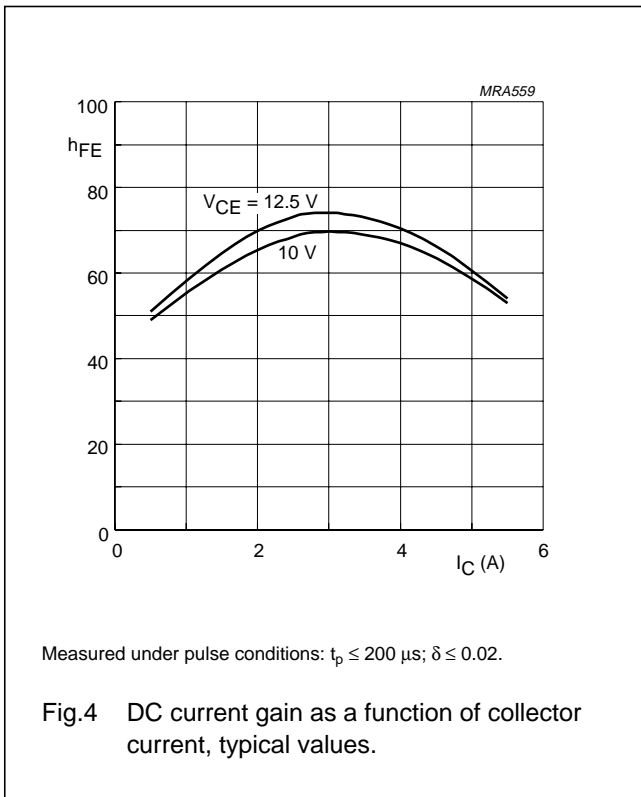

UHF power transistor

BLV193

APPLICATION INFORMATION

RF performance at $T_h = 25\text{ }^\circ\text{C}$ in a common emitter test circuit; $R_{th\ j-mb} = 0.4\text{ K/W}$.

MODE OF OPERATION	f (MHz)	V _{CE} (V)	I _{CQ} (A)	P _L (W)	G _P (dB)	η_c (%)	d _{im} (dB) (note 1)
c.w. class-AB	900	12.5	0.01	12	≥ 6.5 typ. 7.5	> 50 typ. 60	–
c.w. class-A	900	12	1.3	6 (PEP)	typ. 11	–	typ. –30

Note

- 2-tone measurement, $f_p = 900\text{ MHz}$, $f_q = 901\text{ MHz}$.

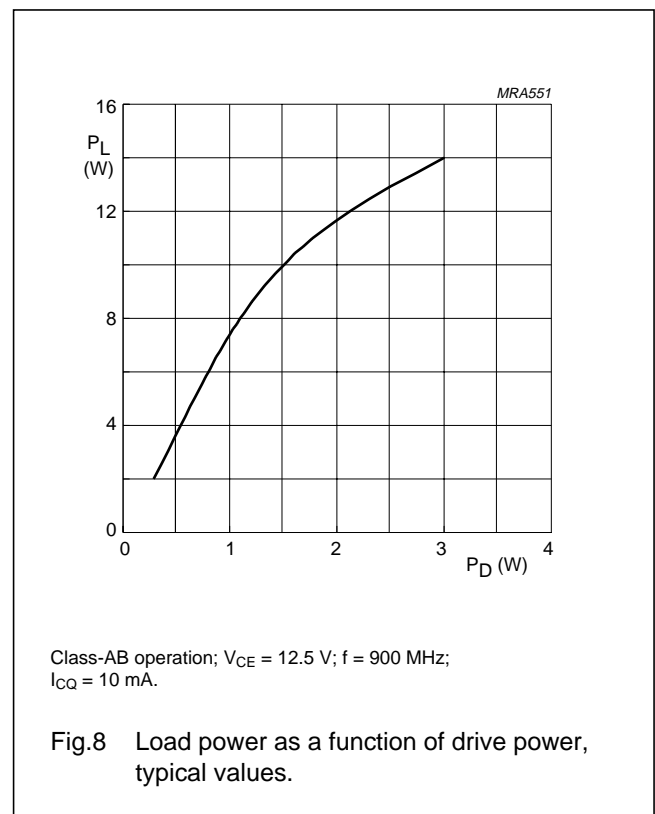
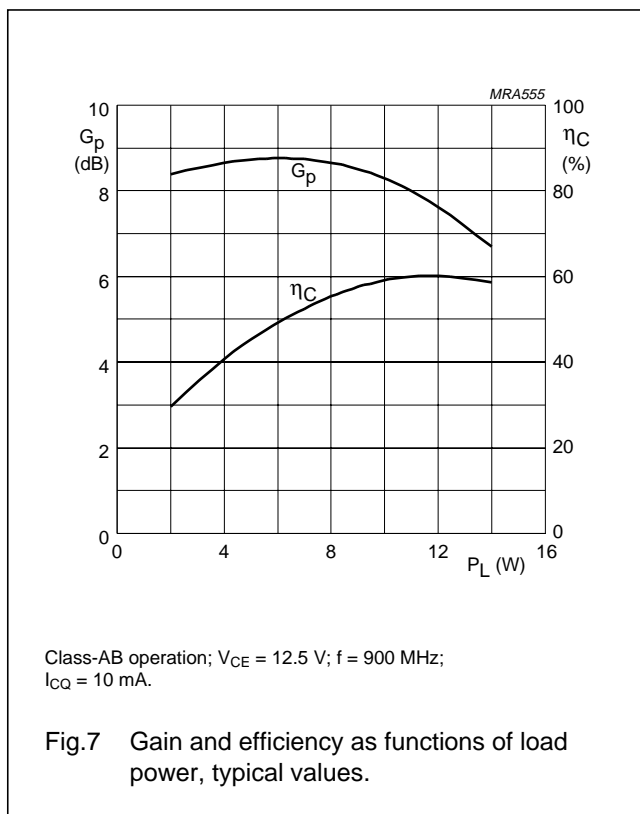

Ruggedness in class-AB operation

The BLV193 is capable of withstanding a load mismatch corresponding to VSWR = 10:1 through all phases under the following conditions:

V_{CE} = 15.5 V, f = 900 MHz,
 T_h = 25 °C, R_{th j-mb} = 0.4 K/W, and
 rated output power.

UHF power transistor

BLV193

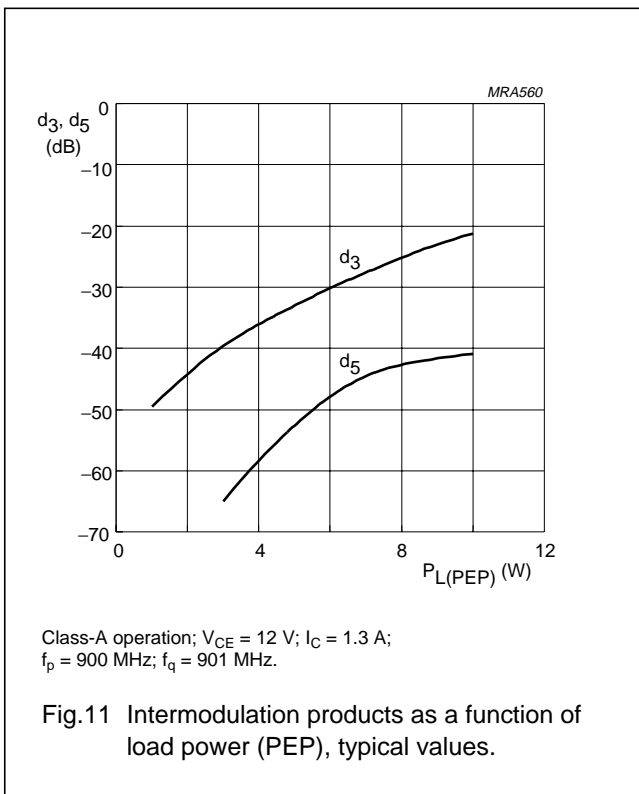
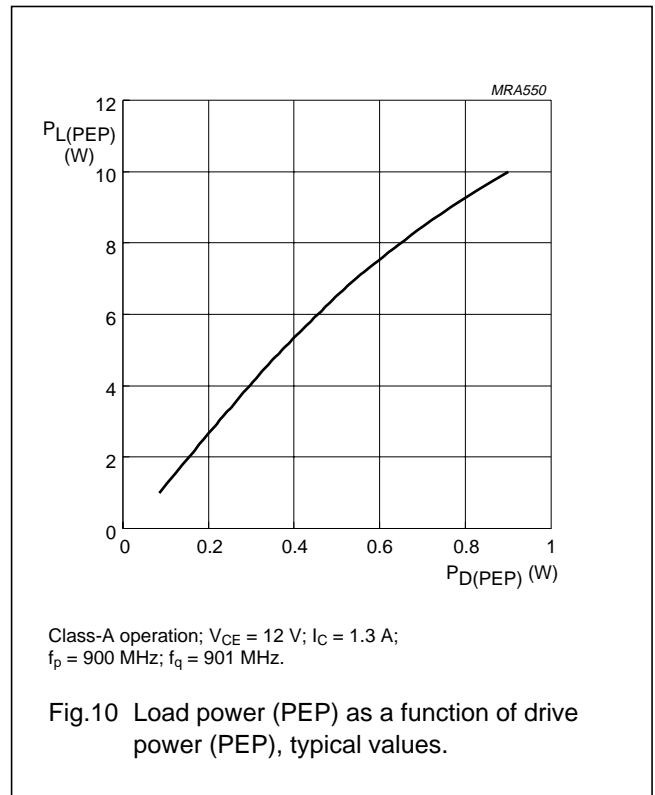
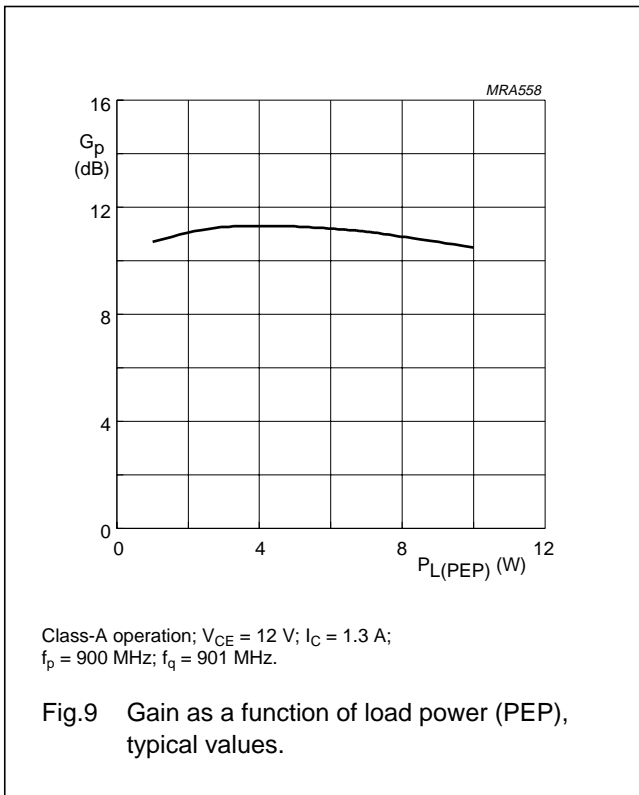

UHF power transistor

BLV193

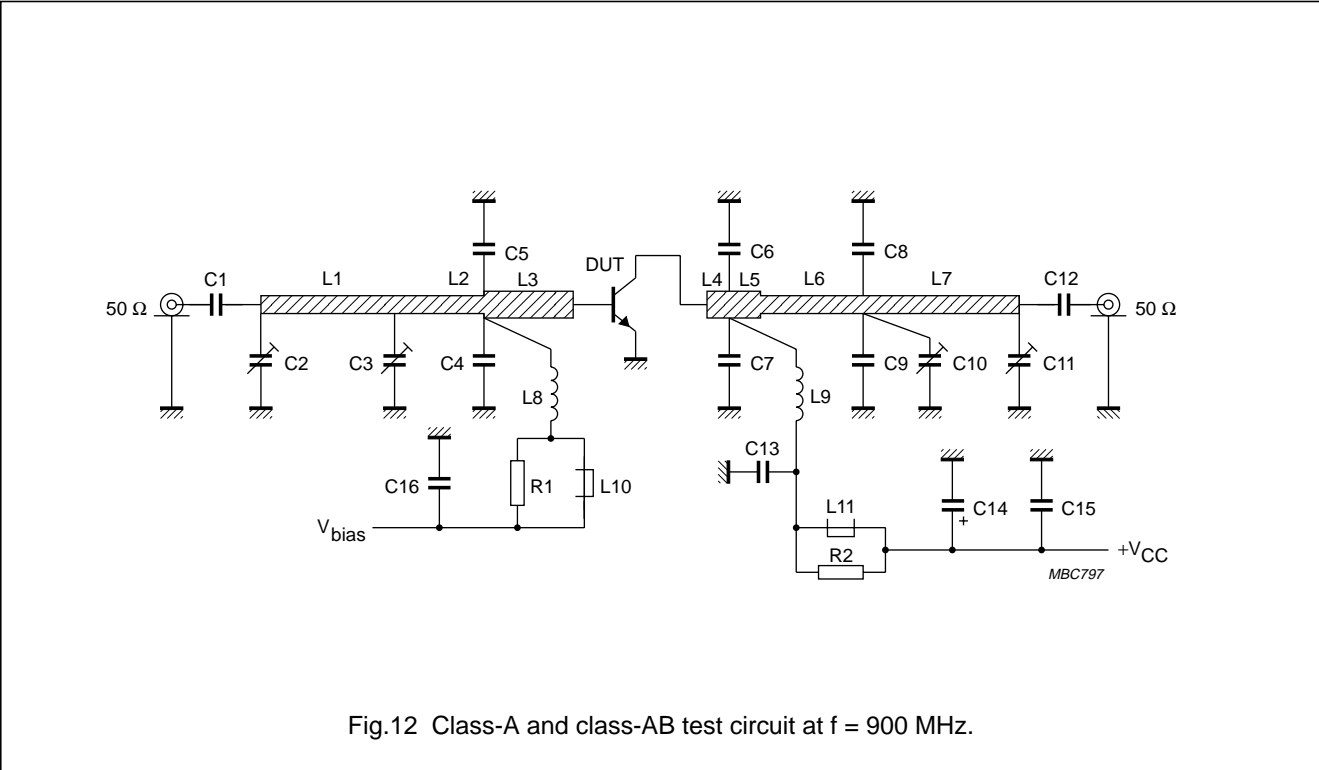

Fig.12 Class-A and class-AB test circuit at f = 900 MHz.

UHF power transistor

BLV193

List of components (see test circuit)

COMPONENT	DESCRIPTION	VALUE	DIMENSIONS	CATALOGUE NO.
C1, C12	multilayer ceramic chip capacitor (note 1)	33 pF		
C2, C3, C10, C11	film dielectric trimmer	1.4 to 5.5 pF		2222 809 09001
C4, C5	multilayer ceramic chip capacitor (note 1)	4.7 pF		
C6, C7	multilayer ceramic chip capacitor (note 1)	5.6 pF		
C8, C9	multilayer ceramic chip capacitor (note 1)	3.3 pF		
C13	multilayer ceramic chip capacitor (note 1)	10 pF		
C14	electrolytic capacitor	6.8 μ F, 63 V		
C15	multilayer ceramic chip capacitor (note 1)	330 pF		
C16	multilayer ceramic chip capacitor	100 nF		2222 852 47104
L1, L7	stripline (note 2)	50 Ω	length 29 mm; width 2.4 mm	
L2	stripline (note 2)	50 Ω	length 6 mm; width 2.4 mm	
L3	stripline (note 2)	42.7 Ω	length 13.1 mm; width 3 mm	
L4	stripline (note 2)	42.7 Ω	length 4.4 mm; width 3 mm	
L5	stripline (note 2)	42.7 Ω	length 4.6 mm; width 3 mm	
L6	stripline (note 2)	50 Ω	length 7 mm; width 2.4 mm	
L8	4 turns closely wound enamelled 0.4 mm copper wire	60 nH	int. dia 3 mm; leads 2 \times 5 mm	
L9	4 turns enamelled 1 mm copper wire	45 nH	int. dia. 4 mm; leads 2 \times 5 mm	
L10, L11	grade 3B Ferroxcube wideband HF choke			4312 020 36642
R1, R2	metal film resistor	10 Ω , 0.25 W		

Notes

- American Technical Ceramics type 100A or capacitor of the same quality.
- The striplines are on a double copper-clad printed circuit board, with PTFE fibre-glass dielectric ($\epsilon_r = 2.2$), thickness $\frac{1}{32}$ inch.

UHF power transistor

BLV193

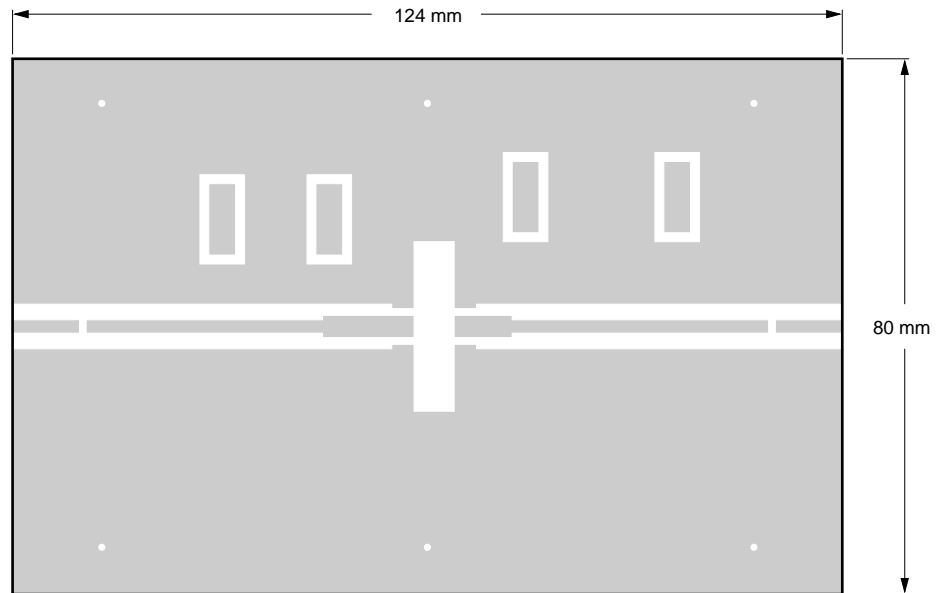

MBC798

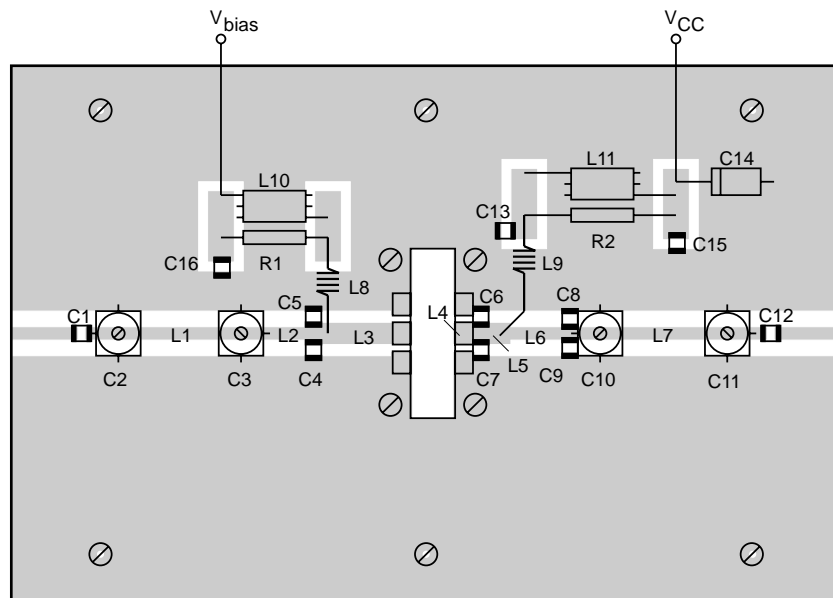

MBC799

The components are mounted on one side of a copper clad PTFE fibre-glass board; the other side is unetched and serves as a ground plane. Earth connections from the component side to the ground plane are made by fixing screws and copper straps under the emitter leads.

Fig.13 Printed circuit board and component layout for 900 MHz test circuit.

UHF power transistor

BLV193

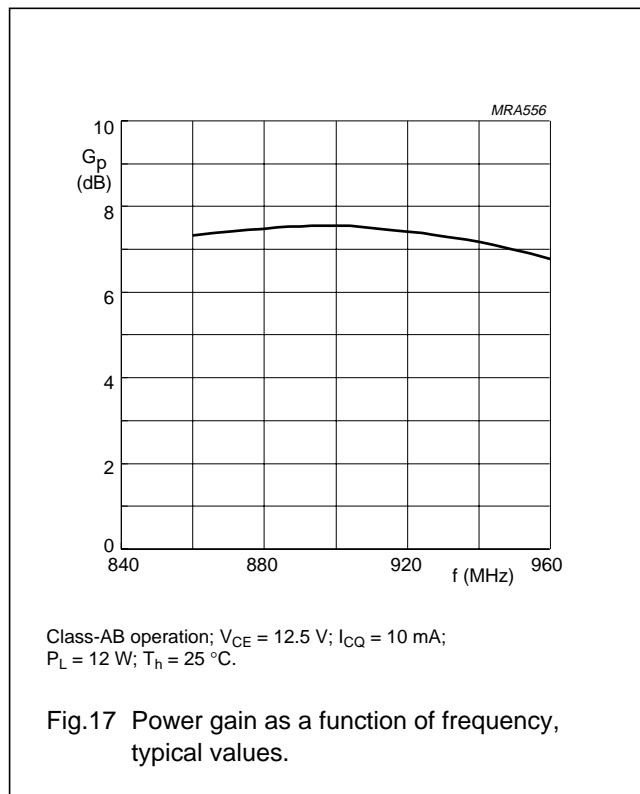
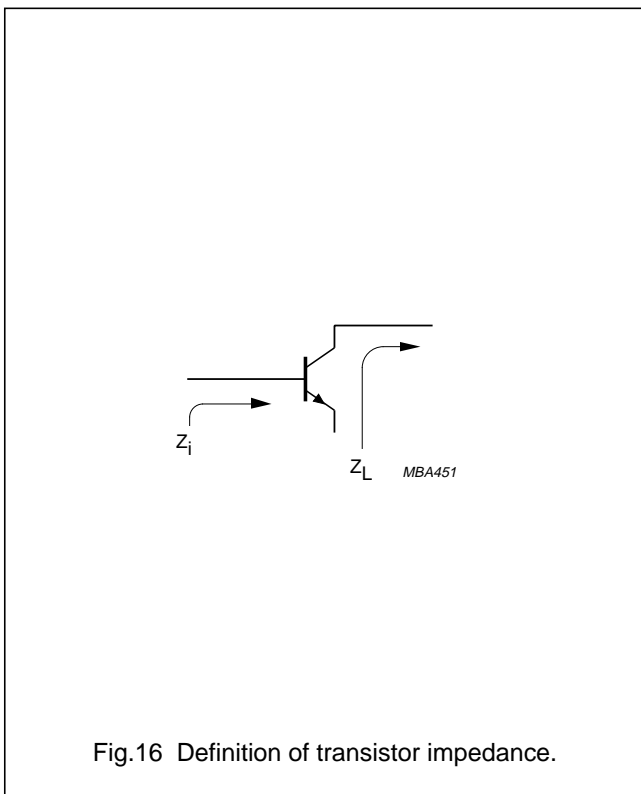
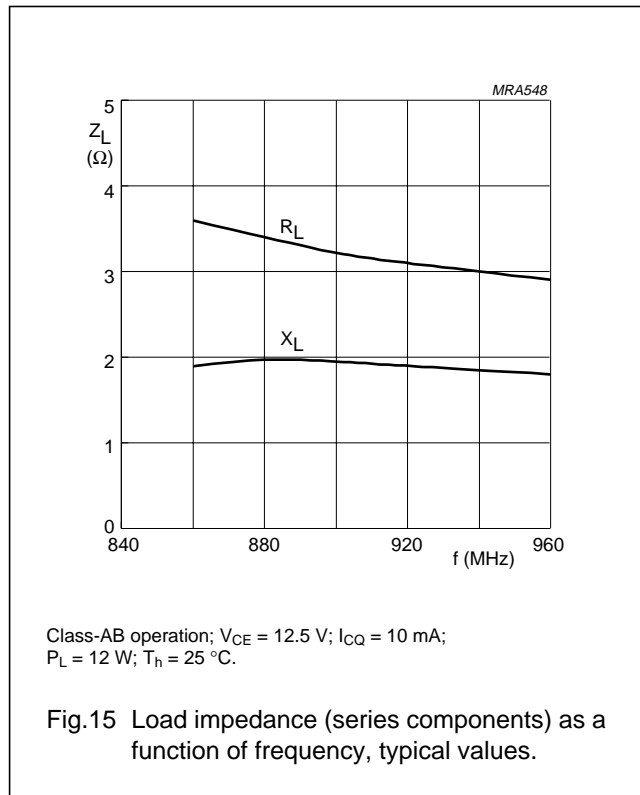
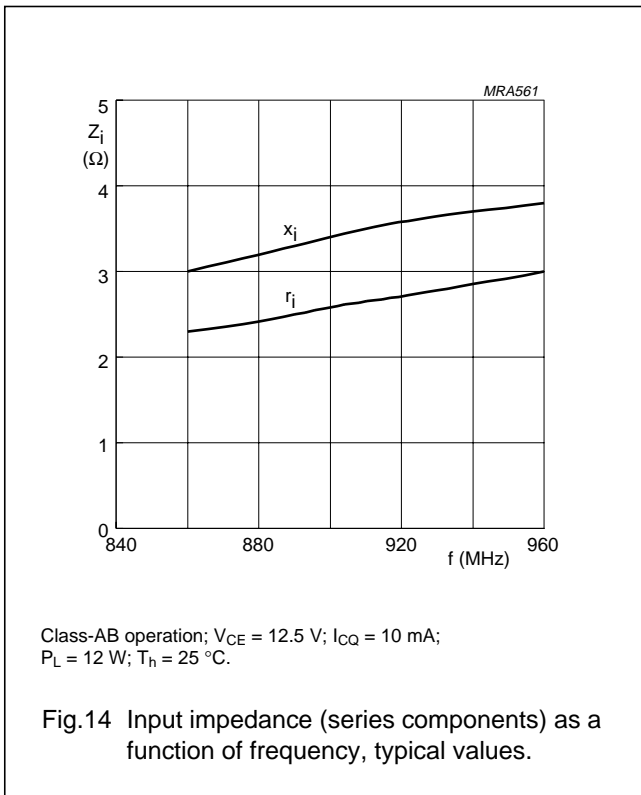

UHF power transistor

BLV193

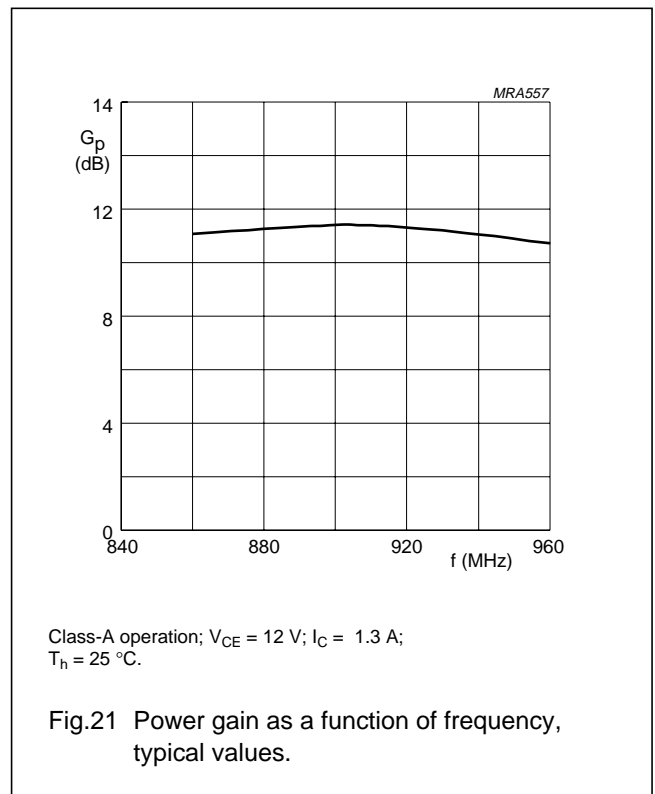
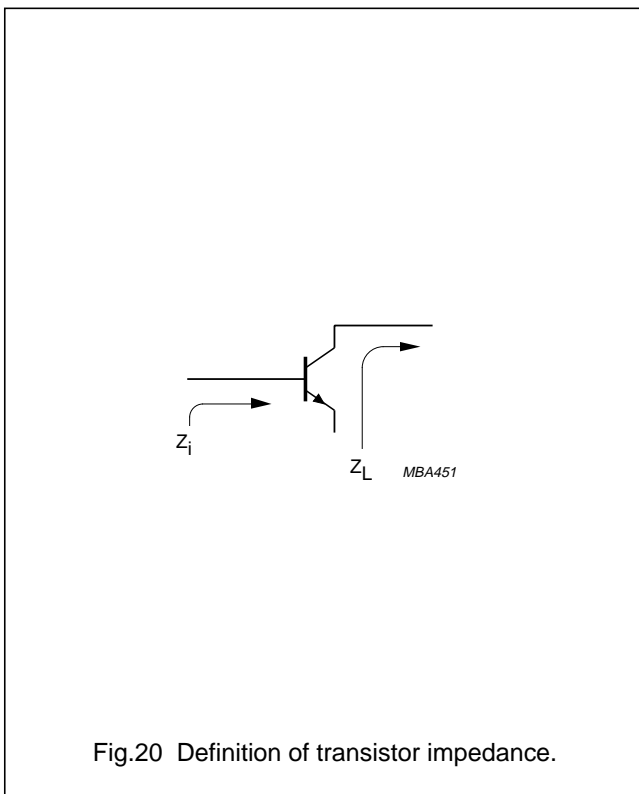
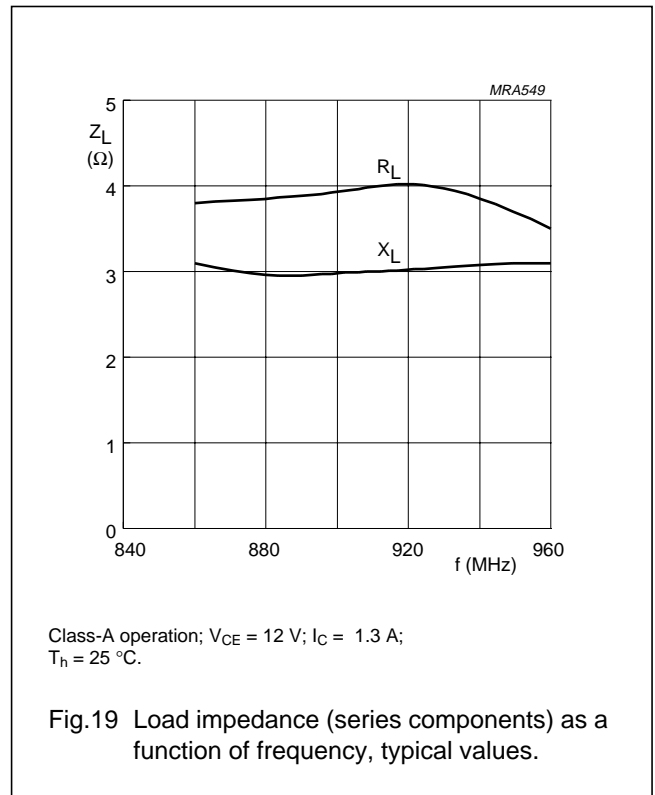
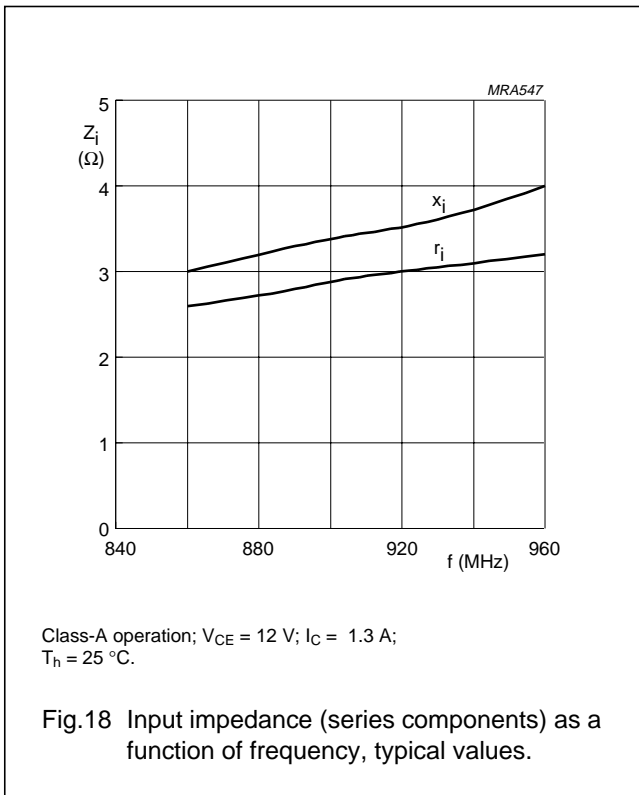

UHF power transistor

BLV193

PACKAGE OUTLINE

Flanged ceramic package; 2 mounting holes; 6 leads

SOT171A

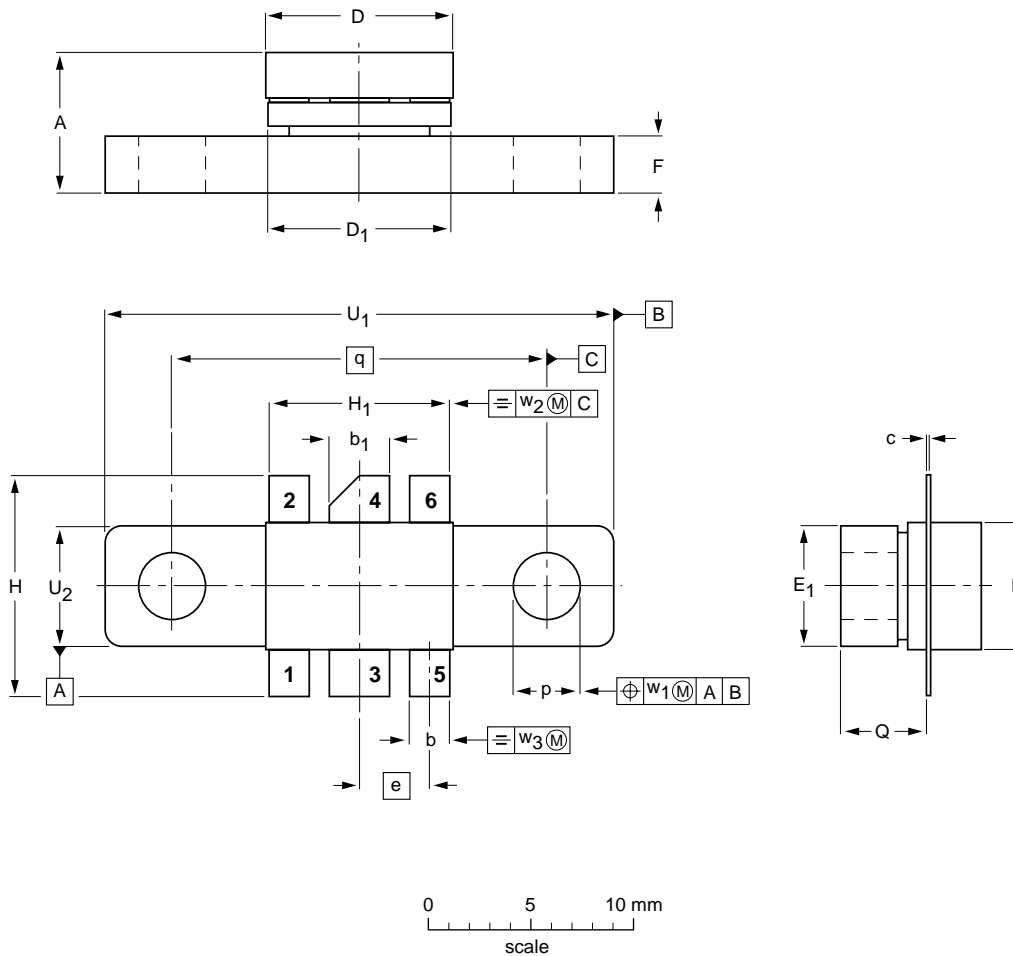

DIMENSIONS (millimetre dimensions are derived from the original inch dimensions)

UNIT	A	b	b ₁	c	D	D ₁	E	E ₁	e	F	H	H ₁	p	Q	q	U ₁	U ₂	w ₁	w ₂	w ₃
mm	6.81 6.07	2.15 1.85	3.20 2.89	0.16 0.07	9.25 9.04	9.30 8.99	5.95 5.74	6.00 5.70	3.58	3.05 2.54	11.31 10.54	9.27 9.01	3.43 3.17	4.32 4.11	18.42	24.90 24.63	6.00 5.70	0.51	1.02	0.26
inches	0.268 0.239	0.085 0.073	0.126 0.114	0.006 0.003	0.364 0.356	0.366 0.354	0.234 0.226	0.236 0.224	0.140	0.120 0.100	0.445 0.415	0.365 0.355	0.135 0.125	0.170 0.162	0.725	0.980 0.970	0.236 0.224	0.02	0.04	0.01

OUTLINE VERSION	REFERENCES				EUROPEAN PROJECTION	ISSUE DATE
	IEC	JEDEC	EIAJ			
SOT171A						97-06-28

UHF power transistor

BLV193

DEFINITIONS

Data Sheet Status	
Objective specification	This data sheet contains target or goal specifications for product development.
Preliminary specification	This data sheet contains preliminary data; supplementary data may be published later.
Product specification	This data sheet contains final product specifications.
Limiting values	
Limiting values given are in accordance with the Absolute Maximum Rating System (IEC 134). Stress above one or more of the limiting values may cause permanent damage to the device. These are stress ratings only and operation of the device at these or at any other conditions above those given in the Characteristics sections of the specification is not implied. Exposure to limiting values for extended periods may affect device reliability.	
Application information	
Where application information is given, it is advisory and does not form part of the specification.	

LIFE SUPPORT APPLICATIONS

These products are not designed for use in life support appliances, devices, or systems where malfunction of these products can reasonably be expected to result in personal injury. Philips customers using or selling these products for use in such applications do so at their own risk and agree to fully indemnify Philips for any damages resulting from such improper use or sale.