

# DATA SHEET

## **BLW87** VHF power transistor

Product specification

August 1986

# VHF power transistor

BLW87

## DESCRIPTION

N-P-N silicon planar epitaxial transistor intended for use in class-A, B and C operated mobile h.f. and v.h.f. transmitters with a nominal supply voltage of 13,5 V. The transistor is resistance stabilized and is guaranteed to withstand severe load mismatch conditions with a supply over-voltage to 16,5 V.

It has a 3/8" flange envelope with a ceramic cap. All leads are isolated from the flange.

## QUICK REFERENCE DATA

R.F. performance up to  $T_h = 25\text{ }^\circ\text{C}$  in an unneutralized common-emitter class-B circuit

MODE OF OPERATION	$V_{CE}$ V	f MHz	$P_L$ W	$G_p$ dB	$\eta$ %	$\bar{z}_i$ $\Omega$	$\bar{Y}_L$ mS
c.w.	13,5	175	25	> 6	> 70	1,6 + j1,4	210 + j5,5

## PIN CONFIGURATION

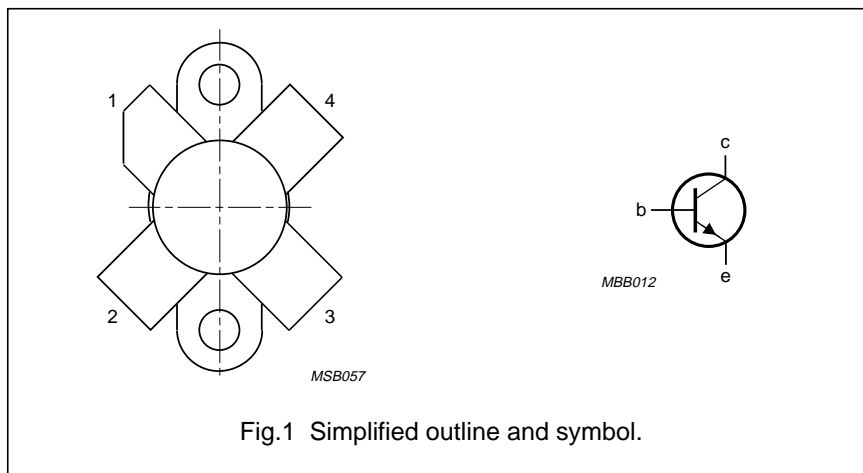

## PINNING - SOT123

PIN	DESCRIPTION
1	collector
2	emitter
3	base
4	emitter

**PRODUCT SAFETY** This device incorporates beryllium oxide, the dust of which is toxic. The device is entirely safe provided that the BeO disc is not damaged.

VHF power transistor

BLW87

**RATINGS**

Limiting values in accordance with the Absolute Maximum System (IEC 134)

Collector-emitter voltage ( $V_{BE} = 0$ )

peak value

$V_{CESM}$  max. 36 V

Collector-emitter voltage (open base)

$V_{CEO}$  max. 18 V

Emitter-base voltage (open collector)

$V_{EBO}$  max. 4 V

Collector current (average)

$I_{C(AV)}$  max. 6 A

Collector current (peak value);  $f > 1$  MHz

$I_{CM}$  max. 12 A

R.F. power dissipation ( $f > 1$  MHz);  $T_{mb} = 25$  °C

$P_{rf}$  max. 76 W

Storage temperature

$T_{stg}$  -65 to + 150 °C

Operating junction temperature

$T_j$  max. 200 °C

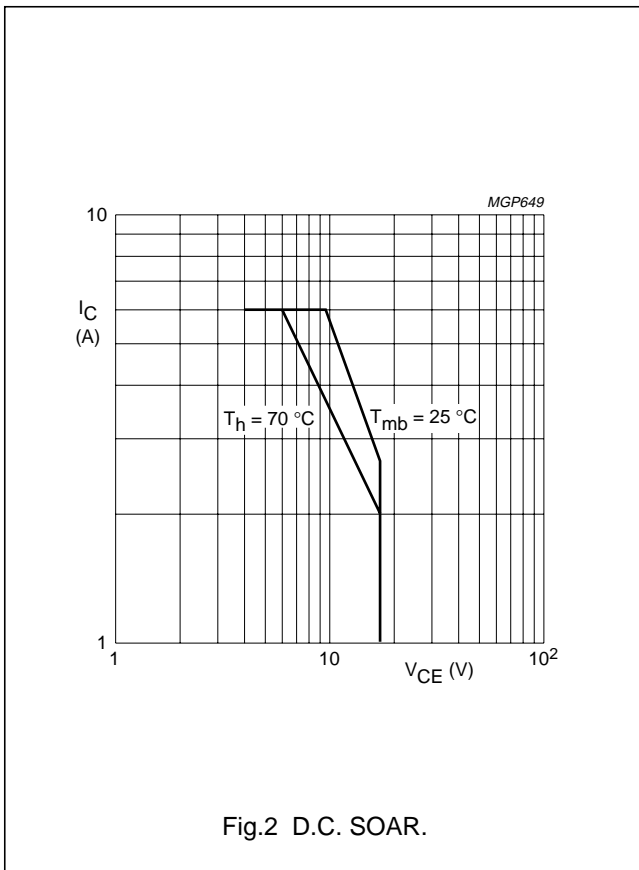

Fig.2 D.C. SOAR.

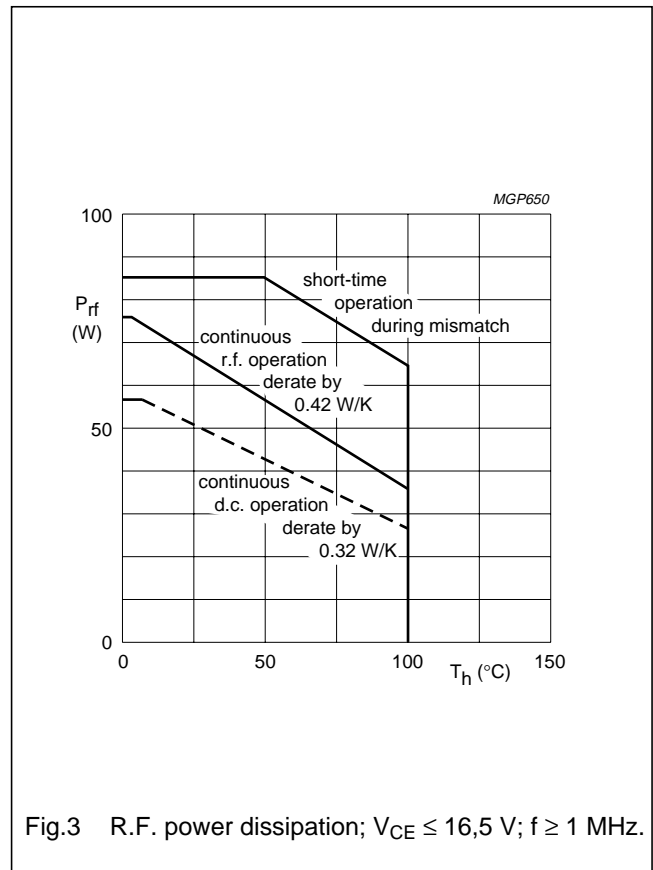

Fig.3 R.F. power dissipation;  $V_{CE} \leq 16,5$  V;  $f \geq 1$  MHz.

**THERMAL RESISTANCE**

(dissipation = 20 W;  $T_{mb} = 76$  °C; i.e.  $T_h = 70$  °C)

From junction to mounting base (d.c. dissipation)

$R_{th\ j-mb(dc)}$  = 3,0 K/W

From junction to mounting base (r.f. dissipation)

$R_{th\ j-mb(rf)}$  = 2,25 K/W

From mounting base to heatsink

$R_{th\ mb-h}$  = 0,3 K/W

## VHF power transistor

BLW87

**CHARACTERISTICS** $T_j = 25\text{ }^\circ\text{C}$ 

Collector-emitter breakdown voltage

 $V_{BE} = 0; I_C = 25\text{ mA}$  $V_{(BR)CES} > 36\text{ V}$ 

Collector-emitter breakdown voltage

open base;  $I_C = 50\text{ mA}$  $V_{(BR)CEO} > 18\text{ V}$ 

Emitter-base breakdown voltage

open collector;  $I_E = 10\text{ mA}$  $V_{(BR)EBO} > 4\text{ V}$ 

Collector cut-off current

 $V_{BE} = 0; V_{CE} = 18\text{ V}$  $I_{CES} < 10\text{ mA}$ Second breakdown energy;  $L = 25\text{ mH}; f = 50\text{ Hz}$ 

open base

 $E_{SBO} > 8\text{ mJ}$  $R_{BE} = 10\ \Omega$  $E_{SBR} > 8\text{ mJ}$ D.C. current gain<sup>(1)</sup> $I_C = 2,5\text{ A}; V_{CE} = 5\text{ V}$ 

typ. 50

 $h_{FE} \quad 10\text{ to }80$ Collector-emitter saturation voltage<sup>(1)</sup> $I_C = 7,5\text{ A}; I_B = 1,5\text{ A}$  $V_{CEsat} \text{ typ. } 1,7\text{ V}$ Transition frequency at  $f = 100\text{ MHz}$ <sup>(1)</sup> $-I_E = 2,5\text{ A}; V_{CB} = 13,5\text{ V}$  $f_T \text{ typ. } 800\text{ MHz}$  $-I_E = 7,5\text{ A}; V_{CB} = 13,5\text{ V}$  $f_T \text{ typ. } 750\text{ MHz}$ Collector capacitance at  $f = 1\text{ MHz}$  $I_E = I_e = 0; V_{CB} = 15\text{ V}$  $C_C \text{ typ. } 65\text{ pF}$ Feedback capacitance at  $f = 1\text{ MHz}$  $I_C = 100\text{ mA}; V_{CE} = 15\text{ V}$  $C_{re} \text{ typ. } 41\text{ pF}$ 

Collector-flange capacitance

 $C_{cf} \text{ typ. } 2\text{ pF}$ **Note**1. Measured under pulse conditions:  $t_p \leq 200\ \mu\text{s}; \delta \leq 0,02$ .

VHF power transistor

BLW87

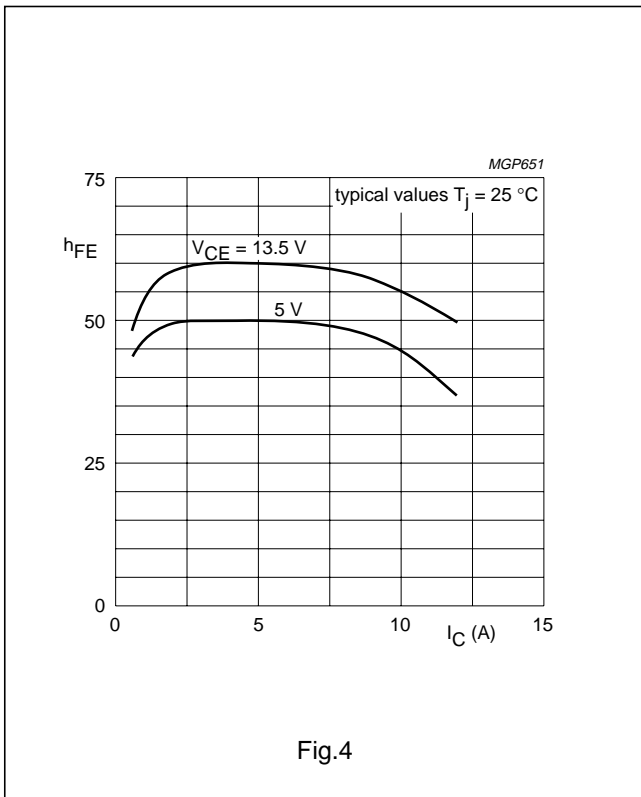

Fig.4

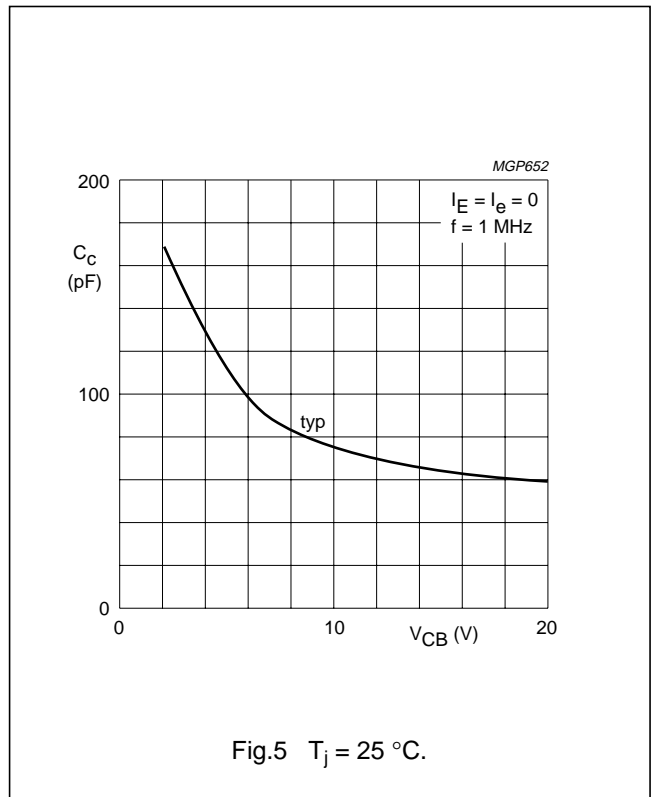

Fig.5  $T_j = 25\text{ }^\circ\text{C}$ .

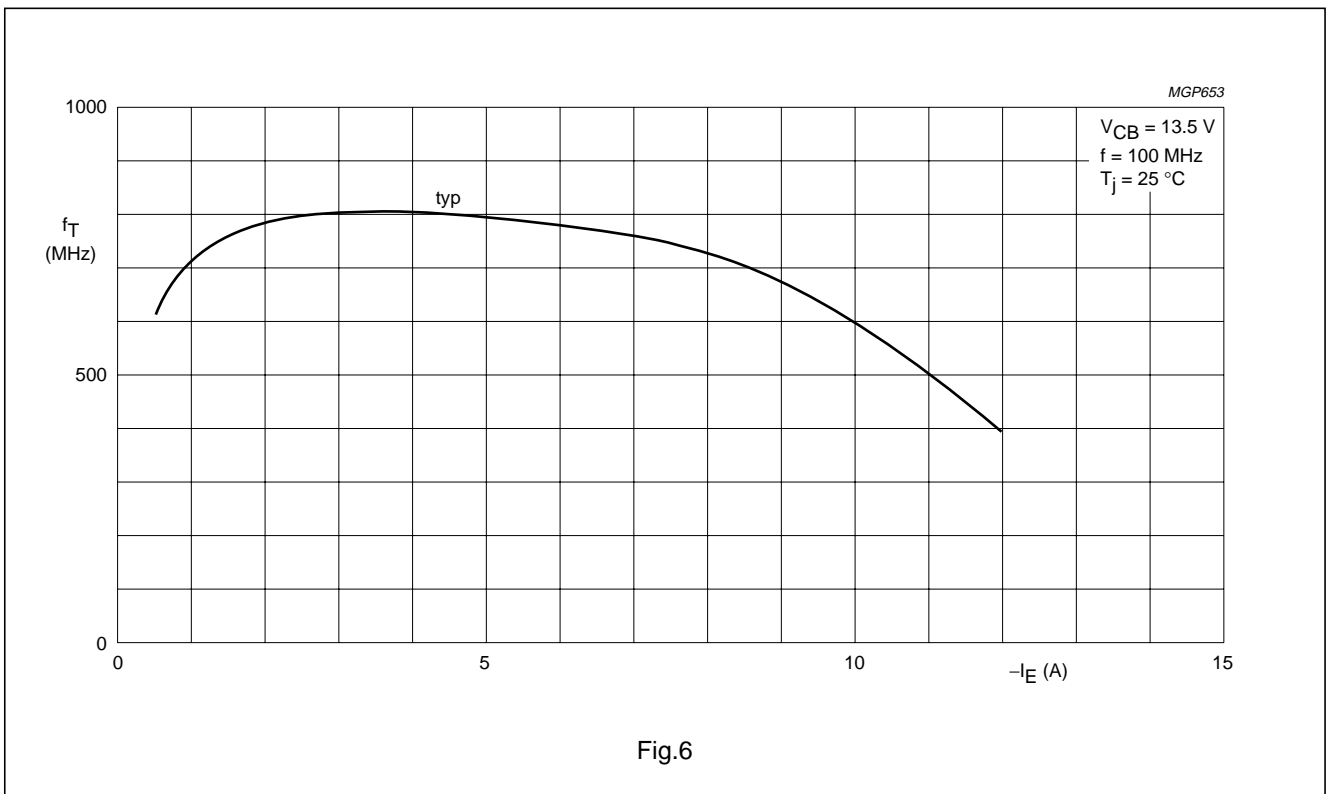

Fig.6

## VHF power transistor

BLW87

## APPLICATION INFORMATION

R.F. performance in c.w. operation (unneutralized common-emitter class-B circuit);  $T_h = 25^\circ\text{C}$ 

f (MHz)	$V_{CE}$ (V)	$P_L$ (W)	$P_S$ (W)	$G_P$ (dB)	$I_C$ (A)	$\eta$ (%)	$\bar{z}_i$ ( $\Omega$ )	$\bar{Y}_L$ (mS)
175	13,5	25	< 6,25	> 6	< 2,64	> 70	1,6 + j1,4	210 + j5,5
175	12,5	25	-	typ. 6,6	-	typ. 75	-	-

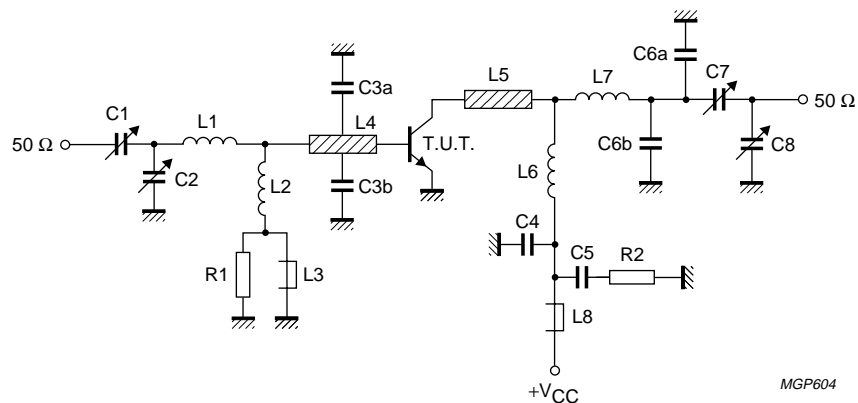

Fig.7 Test circuit; c.w. class-B.

List of components:

- C1 = 2,5 to 20 pF film dielectric trimmer (cat. no. 2222 809 07004)
  - C2 = C8 = 4 to 40 pF film dielectric trimmer (cat. no. 2222 809 07008)
  - C3a = C3b = 47 pF ceramic capacitor (500 V)
  - C4 = 120 pF ceramic capacitor (500 V)
  - C5 = 100 nF polyester capacitor
  - C6a = C6b = 8,2 pF ceramic capacitor (500 V)
  - C7 = 5 to 60 pF film dielectric trimmer (cat. no. 2222 809 07011)
  - L1 = 1 turn Cu wire (1,6 mm); int. dia. 9,0 mm; leads  $2 \times 5$  mm
  - L2 = 100 nH; 7 turns closely wound enamelled Cu wire (0,5 mm); int. dia. 3 mm; leads  $2 \times 5$  mm
  - L3 = L8 = Ferroxcube wide-band h.f. choke, grade 3B (cat. no. 4312 020 36640)
  - L4 = L5 = strip (12 mm  $\times$  6 mm); taps for C3a and C3b at 5 mm from transistor
  - L6 = 2 turns Cu wire (1,6 mm); int. dia. 5,0 mm; length 6,0 mm; leads  $2 \times 5$  mm
  - L7 = 2 turns Cu wire (1,6 mm); int. dia. 4,5 mm; length 6,0 mm; leads  $2 \times 5$  mm
- L4 and L5 are strips on a double Cu-clad printed-circuit board with epoxy fibre-glass dielectric, thickness 1/16".
- R1 = 10  $\Omega$  ( $\pm 10\%$ ) carbon resistor (0,25 W)
  - R2 = 4,7  $\Omega$  ( $\pm 5\%$ ) carbon resistor (0,25 W)

Component layout and printed-circuit board for 175 MHz test circuit are shown in Fig.8.

VHF power transistor

BLW87

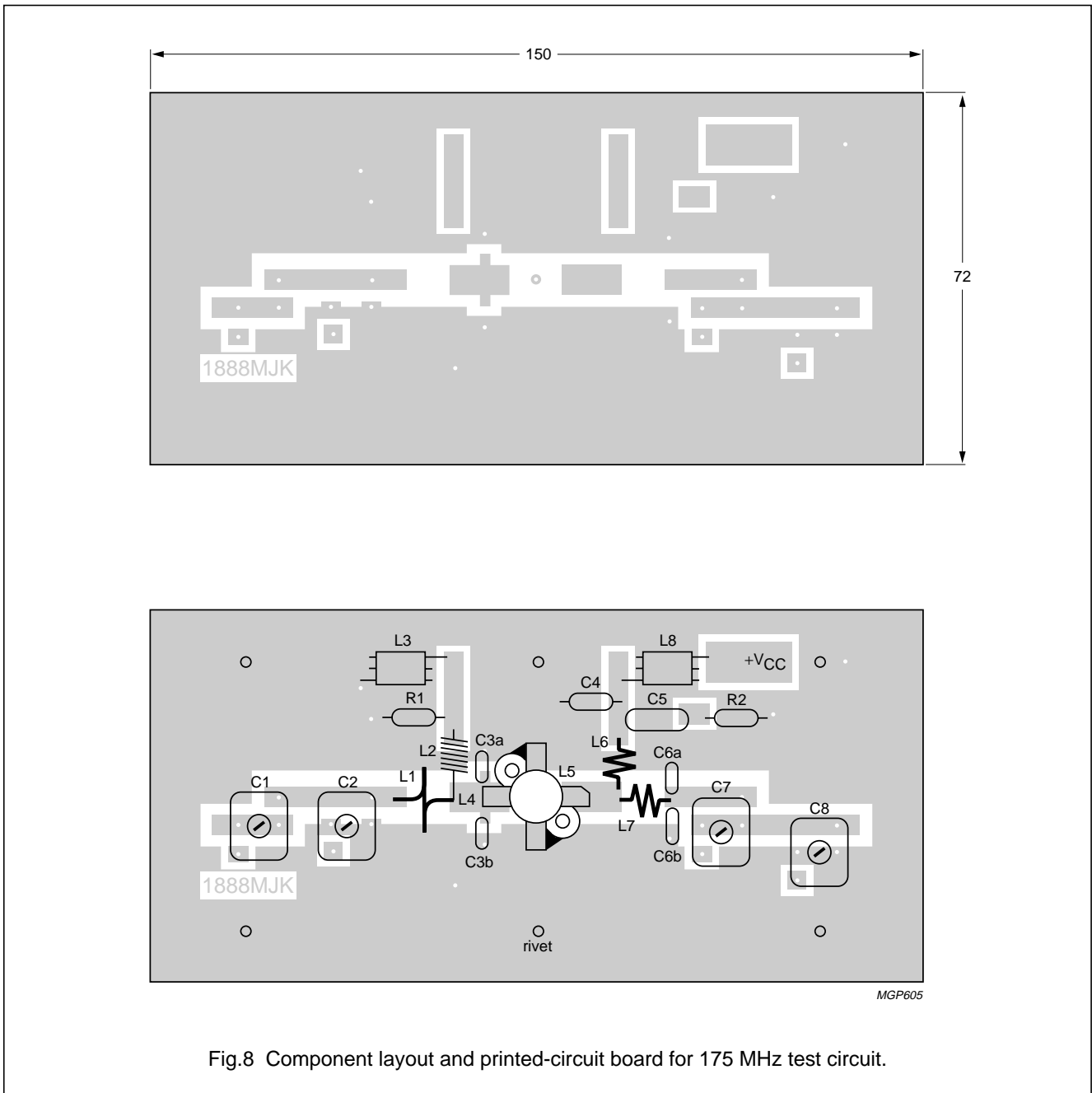

Fig.8 Component layout and printed-circuit board for 175 MHz test circuit.

The circuit and the components are situated on one side of the epoxy fibre-glass board, the other side being fully metallized to serve as earth. Earth connections are made by means of hollow rivets, whilst under the emitter leads Cu straps are used for a direct contact between upper and lower sheets.

VHF power transistor

BLW87

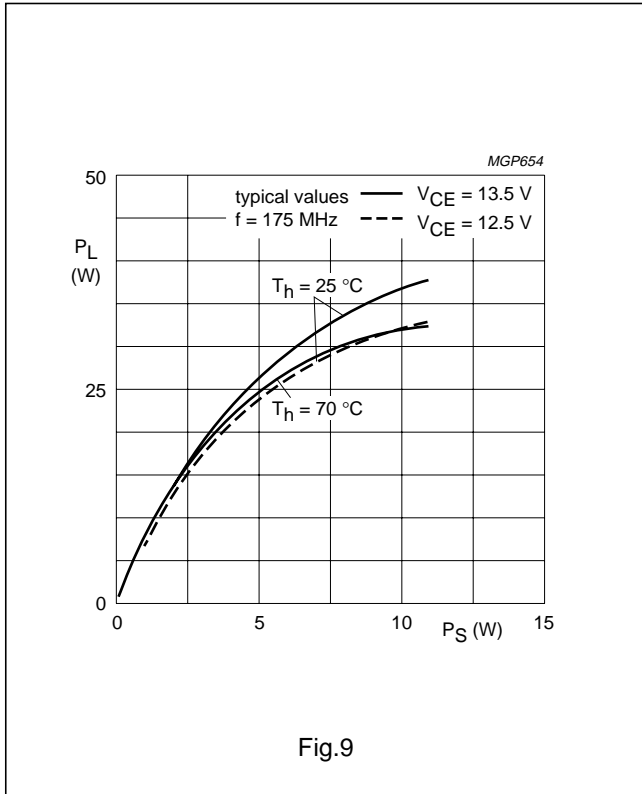

Fig.9

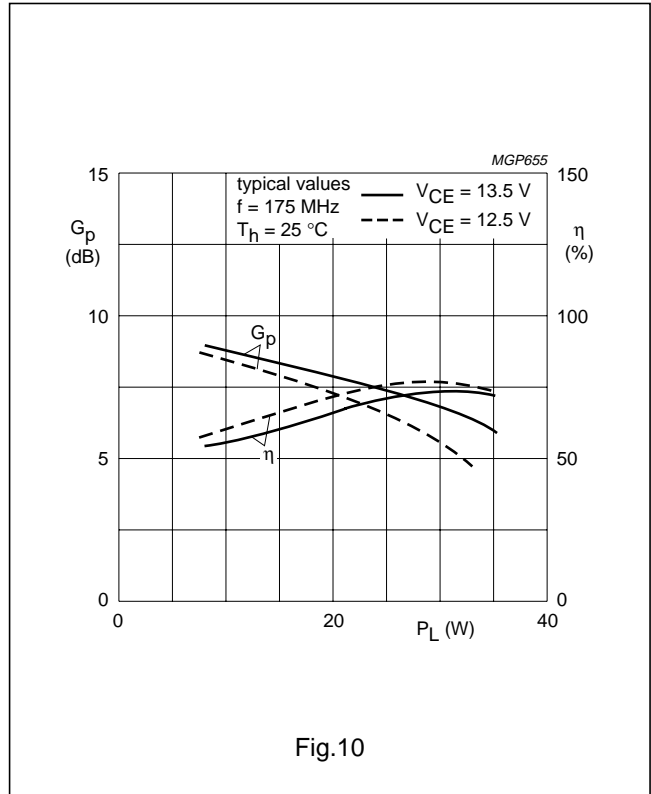

Fig.10

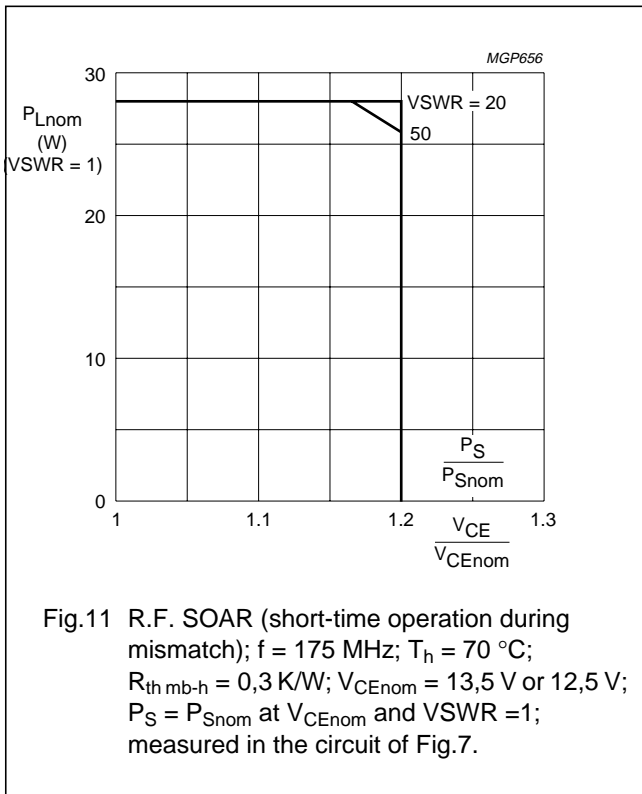

Fig.11 R.F. SOAR (short-time operation during mismatch);  $f = 175 \text{ MHz}$ ;  $T_h = 70 \text{ }^\circ\text{C}$ ;  $R_{th\text{ mb-h}} = 0,3 \text{ K/W}$ ;  $V_{CE\text{ nom}} = 13,5 \text{ V}$  or  $12,5 \text{ V}$ ;  $P_S = P_{S\text{ nom}}$  at  $V_{CE\text{ nom}}$  and  $V_{SWR} = 1$ ; measured in the circuit of Fig.7.

The transistor has been developed for use with unstabilized supply voltages. As the output power and drive power increase with the supply voltage, the nominal output power must be derated in accordance with the graph for safe operation at supply voltages other than the nominal. The graph shows the permissible output power under nominal conditions ( $V_{SWR} = 1$ ), as a function of the expected supply over-voltage ratio with  $V_{SWR}$  as parameter.

The graph applies to the situation in which the drive ( $P_S/P_{S\text{ nom}}$ ) increases linearly with supply over-voltage ratio.



VHF power transistor

BLW87

**OPERATING NOTE**

Below 50 MHz a base-emitter resistor of 10 Ω is recommended to avoid oscillation. This resistor must be effective for r.f. only.

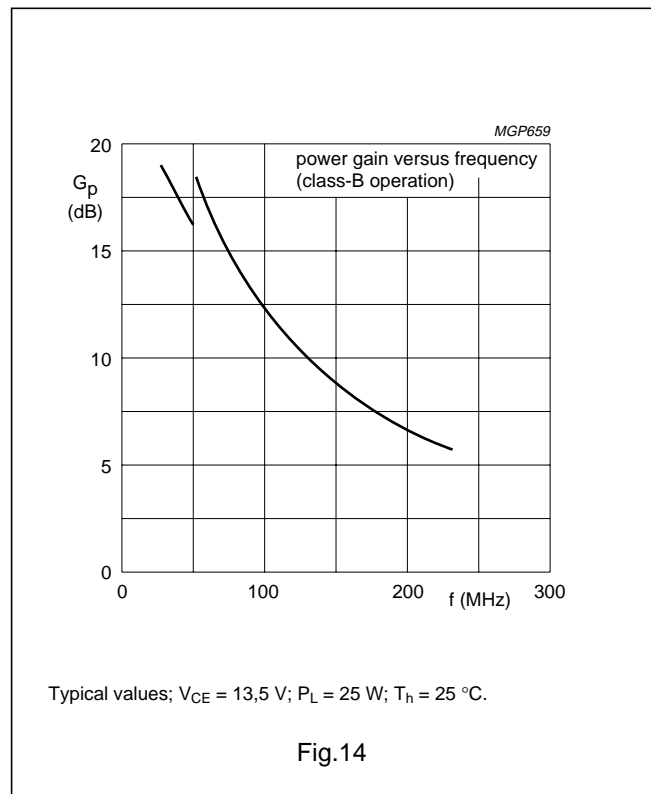
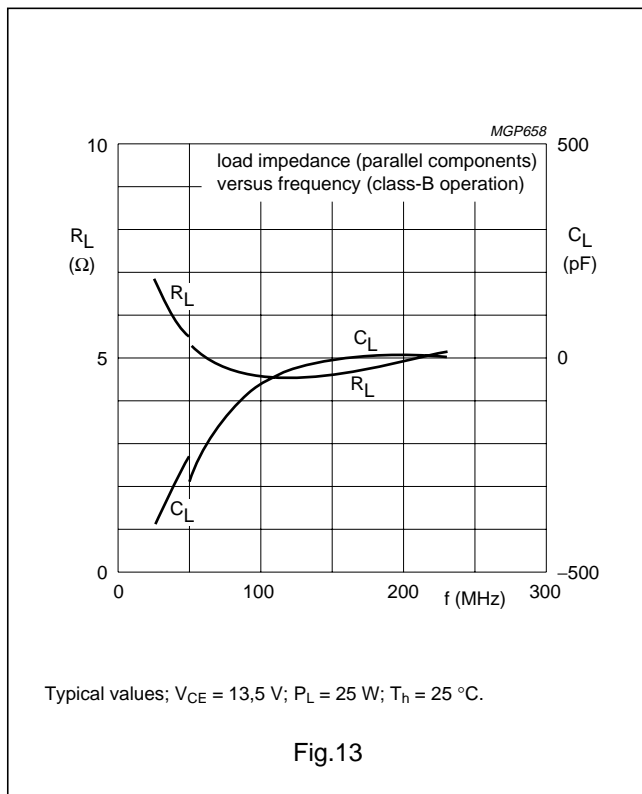
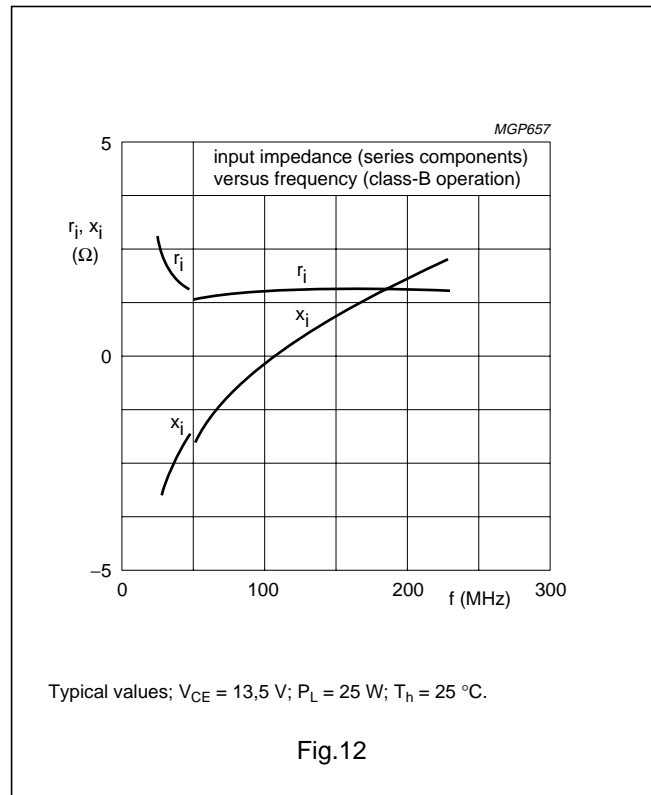

VHF power transistor

BLW87

PACKAGE OUTLINE

Flanged ceramic package; 2 mounting holes; 4 leads

SOT123A



DIMENSIONS (millimetre dimensions are derived from the original inch dimensions)

UNIT	A	b	c	D	D <sub>1</sub>	F	H	L	p	Q	q	U <sub>1</sub>	U <sub>2</sub>	U <sub>3</sub>	w <sub>1</sub>	w <sub>2</sub>	α
mm	7.47 6.37	5.82 5.56	0.18 0.10	9.73 9.47	9.63 9.42	2.72 2.31	20.71 19.93	5.61 5.16	3.33 3.04	4.63 4.11	18.42	25.15 24.38	6.61 6.09	9.78 9.39	0.51	1.02	45°
inches	0.294 0.251	0.229 0.219	0.007 0.004	0.383 0.373	0.397 0.371	0.107 0.091	0.815 0.785	0.221 0.203	0.131 0.120	0.182 0.162	0.725	0.99 0.96	0.26 0.24	0.385 0.370	0.02	0.04	

OUTLINE VERSION	REFERENCES				EUROPEAN PROJECTION	ISSUE DATE
	IEC	JEDEC	EIAJ			
SOT123A						97-06-28

## VHF power transistor

BLW87

**DEFINITIONS**

<b>Data Sheet Status</b>	
Objective specification	This data sheet contains target or goal specifications for product development.
Preliminary specification	This data sheet contains preliminary data; supplementary data may be published later.
Product specification	This data sheet contains final product specifications.
<b>Limiting values</b>	
Limiting values given are in accordance with the Absolute Maximum Rating System (IEC 134). Stress above one or more of the limiting values may cause permanent damage to the device. These are stress ratings only and operation of the device at these or at any other conditions above those given in the Characteristics sections of the specification is not implied. Exposure to limiting values for extended periods may affect device reliability.	
<b>Application information</b>	
Where application information is given, it is advisory and does not form part of the specification.	

**LIFE SUPPORT APPLICATIONS**

These products are not designed for use in life support appliances, devices, or systems where malfunction of these products can reasonably be expected to result in personal injury. Philips customers using or selling these products for use in such applications do so at their own risk and agree to fully indemnify Philips for any damages resulting from such improper use or sale.