

AC / DC converter unit

BP5034A12

The BP5034A12 is an AC / DC converter which can be used to supply + 12V, 100mA DC output from a commercial power supply (100V AC). Using this unit enables simple, easy drive of microcomputers, LEDs, and other electronic components without using a transformer. It also allows set PCBs to be kept compact and lightweight, with extremely few attachments.

●Applications

Power supply circuits for vacuum cleaners, washing machines, refrigerators, electric carpets, electric rice cookers and hot water pots, irons, cordless telephones, air purifiers, humidifiers, dehumidifiers, illumination devices and other small household appliances, as well as power supply circuits for gas, fire and smoke alarms, DC motors, sensors, and other similar devices

●Features

- 1) Elimination of a transformer enables compact, lightweight power supply boards.
- 2) Wide input voltage range. (80 to 120V for AC voltage conversion)
- 3) DC circuits can be easily configured, with few attachments.
- 4) Since no transformer is used, the power supply board is less vulnerable to splitting or cracking from impact or shock.
- 5) Hybridization of the IC reduces the number of labor hours in the assembly process.

●Absolute maximum ratings (Ta = 25°C)

Parameter	Symbol	Limits	Unit
Power supply voltage	V _{CC}	170	V
Power dissipation	I _o	100	mA
Operating temperature	T _{opr}	-25~+80	°C
Storage temperature	T _{stg}	-25~+105	°C

●Recommended operating conditions (Ta = 25°C)

Parameter	Symbol	Min.	Typ.	Max.	Unit
Power supply voltage	V _{CC}	113	141	170	V _(DC)

●Electrical characteristics (unless otherwise noted, $T_a = 25^\circ\text{C}$)

Parameter	Symbol	Min.	Typ.	Max.	Unit	Conditions
Input voltage	V_i	113	141	170	V	DC
Output voltage	V_o	11	12	13	V	$V_i=141\text{V}$, $I_o=50\text{mA}$
Output current	I_o	0	—	100	mA	$V_i=141\text{V}^{*1}$
Line regulation	V_r	—	0.02	0.1	V	$V_i=113\text{V}\sim 170\text{V}$, $I_o=50\text{mA}$
Load regulation	V_l	—	0.05	0.15	V	$V_i=141\text{V}$, $I_o=0\sim 50\text{mA}$
Output ripple voltage	V_p	—	0.05	0.15	V_{P-P}	$V_i=141\text{V}$, $I_o=50\text{mA}^{*2}$
Power conversion efficiency	η	50	60	—	%	$V_i=141\text{V}$, $I_o=100\text{mA}$

*1 Maximum output varies depending on ambient temperature; please refer to derating curve.

*2 Output ripple voltage does not include spike noise.

●Electrical characteristics (unless otherwise noted, $T_a = 25^\circ\text{C}$)

Pin No.	Pin name
1	V_{out}
2	N.C.
3	Internal connection
4	N.C.
5	COMMON
6	COMMON *1
7	Internal connection
8	N.C.
10	V_{in}

*1 Pin 6 is the COMMON pin and is connected internally to pin 5. Use either both, or one or the other, as the COMMON pin. Keep open the other pins that are not used.

Pin 9 is removed.

●Measurement circuit

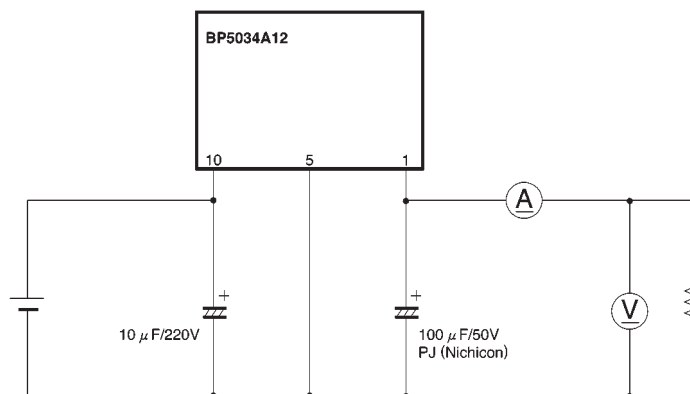

Fig.1

●Application example

Example showing charger of cordless telephone (hand-held set)

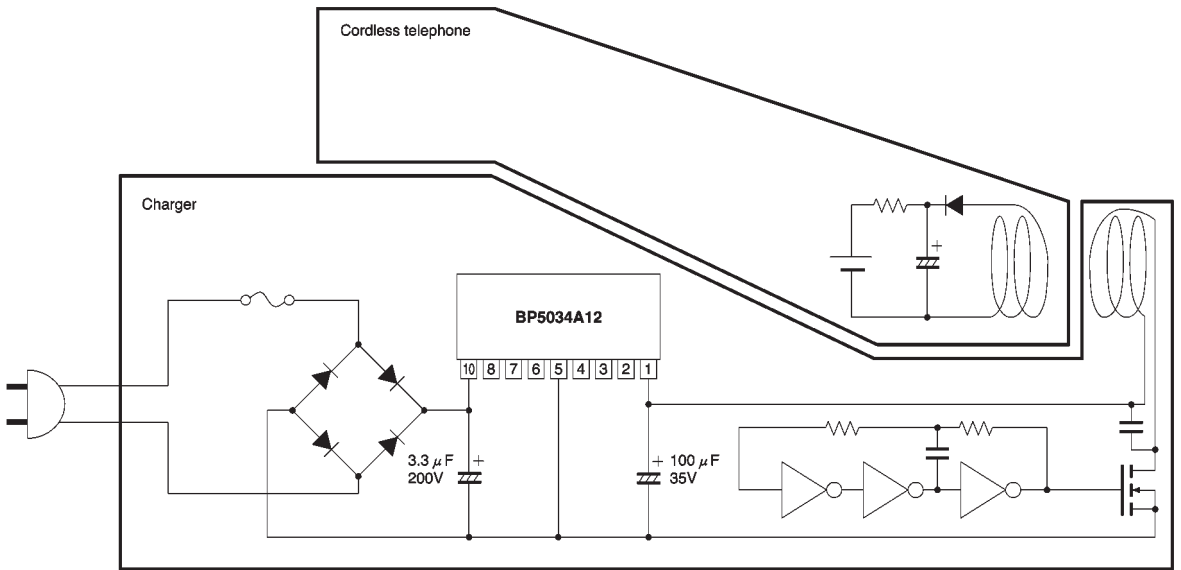

Fig.2

●Basic power supply circuit

Half wave rectification circuit

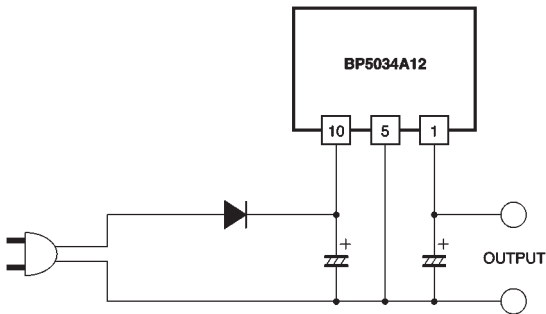

Fig.3

Full wave rectification circuit

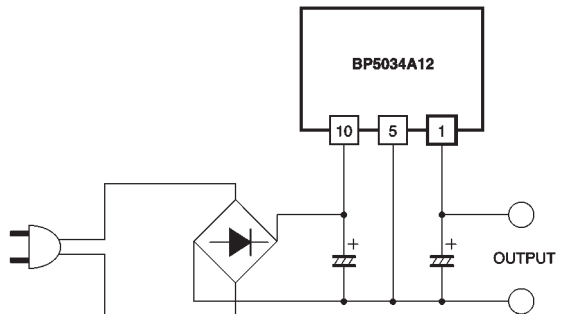

Fig.4

●Selecting attached components

(1) Diodes

The rectifying diodes used should fulfill the following conditions.

In the absolute maximum ratings, the reverse surge current should be 400V or higher, the average rectifying current should be 0.5A or higher, and the forward surge voltage should be 20A or higher. For example, 1SR35–400A is recommended.

(2) Capacitor for input voltage smoothing

A capacitor with a larger value produces a more stable output voltage, but increases the surge current when the power supply is turned on. The capacitor should have a withstand resistance of at least 200V. Please refer to Figure 5 for examples of recommended capacitance values.

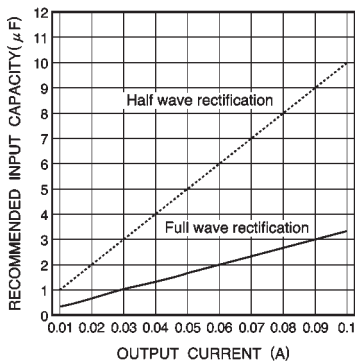

Fig.5 Recommended values for input capacitor

●Operation notes

(1) The output current needs to be reduced as the ambient temperature rises.

(2) Lead pins should be securely soldered. If common pins are not securely connected, or pins which are connected internally but which are not used are connected to other pins, irregular voltages could be produced, causing breakdowns and damage.

(3) Over current and short circuit

The over current limit is a drooping model. At 25°C, if over current which exceeds the absolute maximum ratings is produced intermittently, or is produced continuously for a total of one minute or longer, the product is vulnerable to damage. If there is any danger of the load being shorted or over current being produced, always use a protective device such as a fuse.

(3) Capacitor for output voltage smoothing

This capacitor should have a low ESR. Capacitors designed for low-impedance switching power supplies are especially suitable. The ESR of the capacitor affects the output ripple voltage. Please refer to the table below for the names of products made by various manufacturers.

Maker	Product
Nichicon	PJ series
Matsushita electric	Model A FA series

(4) Avoid subjecting this product to strong impact.

(5) Regulations governing electrical products

As a stand-alone product, this product is not subject to regulations governing electrical appliances. Please be aware, therefore, that applications must be submitted for sets and not for individual products.

(6) Insulation

This product is not insulated on the primary and secondary sides, and there is a danger of electrical shock if it is touched.

(7) Connections with other devices

Devices using this product should not be connected to other devices. If connected, insulation should be provided.

●Electrical characteristic curves

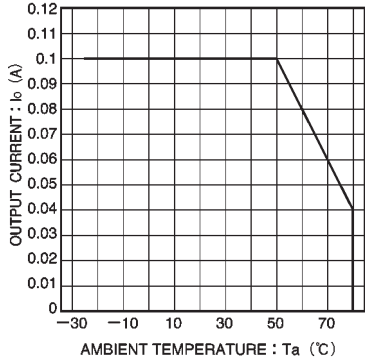

Fig.6 Derating curve

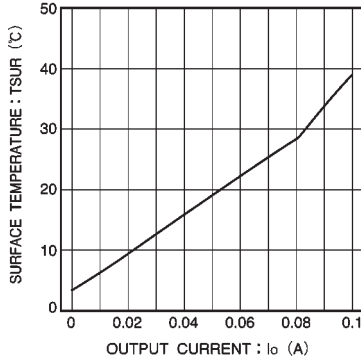

Fig.7 Surface temperature rise

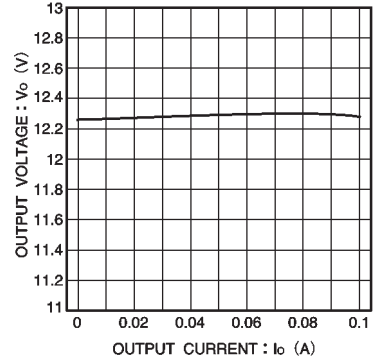

Fig.8 Output characteristic

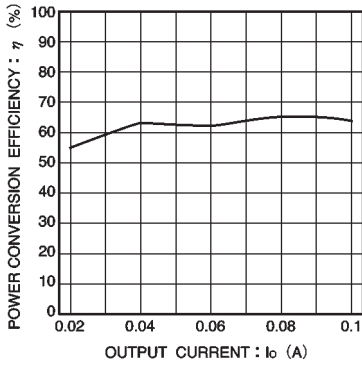

Fig.9 Power conversion efficiency

●External dimensions (Units: mm)

