

AC / DC converter

BP5039-12 / BP5039-15 / BP5039A

The BP5039-12, BP5039-15 and BP5039A are AC / DC converters which provide DC output from a commercial power supply (100V AC). Using these modules enable simple, easy drive of microcomputers, LEDs, and many other electronic components without using a transformer. They allow set PCBs to be kept compact and lightweight, with extremely few attachments.

●Applications

Power supply circuits for vacuum cleaners, washing machines, refrigerators, electric carpets, electric rice cookers and crock pots, irons, cordless telephones, air conditioners, air purifiers, humidifiers, dehumidifiers, illumination devices and other small household appliance, as well as power supply circuits for gas, fire and smoke alarms, DC motors, sensors, and other similar devices.

●Features

- 1) Elimination of a transformer enables compact, lightweight power supply boards.
- 2) Wide input voltage range.(80 to 120Vrms for AC voltage conversion.)
- 3) DC power supply can be easily configured, with few attachments.
- 4) Because no transformer is used, the power supply board is less vulnerable to splitting or cracking from impact or shock.
- 5) Allow easy assemblage of components.

●List of the BP5039 series

Parameter	BP5039-12	BP5039-15	BP5039A	Unit
Power supply voltage	113~170	113~170	113~170	V
Output voltage	12	15	24	V
Output current	300	200	200	mA

●Absolute maximum ratings (Ta = 25°C)

Parameter	Symbol	Limits			Unit
		BP5039-12	BP5039-15	BP5039A	
Power supply voltage	V _{IN}	170	170	170	V
Output current	I _o	300	200	200	mA
Operating temperature range	T _{opr}	-20~+80	-25~+80	-20~+80	°C
Storage temperature range	T _{stg}	-25~+105	-25~+105	-25~+105	°C

●Recommended operating conditions (Ta = 25°C)

Parameter	Symbol	Min.	Typ.	Max.	Unit
Power supply voltage	V _{IN}	113	141	170	V(DC)

BP5039-12 / BP5039-15 / BP5039A

Power Module

●Electrical characteristics (unless otherwise noted, Ta = 25°C)

BP5039-12

Parameter	Symbol	Min.	Typ.	Max.	Unit	Conditions
Input voltage	V _{IN}	113	141	170	V	DC
Output voltage	V _o	11	12	13	V	V _{IN} = 141V, I _o = 100mA
Output current	I _o	0	–	300	mA	V _{IN} = 141V *1
Line regulation	V _r	-0.10	0.04	+0.10	V	V _{IN} = 113V~170V, I _o = 100mA
Load regulation	V _l	-0.20	0.05	+0.20	V	V _{IN} = 141V, I _o = 0~100mA
Output ripple voltage	V _p	–	0.07	0.15	V _{PP}	V _{IN} = 141V, I _o = 100mA *2
Conversion efficiency	η	65	74	–	%	V _{IN} = 141V, I _o = 300mA

*1 Maximum output current varies depending on ambient temperature; please refer to derating curve.

*2 Spike noise is not included in output ripple voltage.

BP5039-15

Parameter	Symbol	Min.	Typ.	Max.	Unit	Conditions
Input voltage	V _{IN}	113	141	170	V	DC
Output voltage	V _o	14.25	15.0	15.75	V	V _{IN} = 141V *1
Output current	I _o	0	–	200	mA	V _{IN} = 113V~170V, I _o = 100mA
Line regulation	V _r	-0.20	0.05	+0.20	V	V _{IN} = 141V, I _o = 0~100mA
Load regulation	V _l	-0.20	0.05	+0.20	V	V _{IN} = 141V, I _o = 100mA *2
Output ripple voltage	V _p	–	0.07	0.15	V _{PP}	V _{IN} = 141V, I _o = 200mA
Conversion efficiency	η	60	74	–	%	V _{IN} = 141V, I _o = 200mA
Surface temperature rise	T _c	–	38	–	K	V _{IN} = 141V, I _o = 200mA

*1 Maximum output current varies depending on ambient temperature; please refer to derating curve.

*2 Spike noise is not included in output ripple voltage.

BA5039A

Parameter	Symbol	Min.	Typ.	Max.	Unit	Conditions
Input voltage	V _{IN}	113	141	170	V	DC
Output voltage	V _o	22	24	26	V	V _{IN} = 141V, I _o = 100mA
Output current	I _o	0	–	200	mA	V _{IN} = 141V *1
Line regulation	V _r	-0.15	0.04	+0.15	V	V _{IN} = 113V~170V, I _o = 100mA
Load regulation	V _l	-0.50	0.25	+0.50	V	V _{IN} = 141V, I _o = 0~100mA
Output ripple voltage	V _p	–	0.07	–	V _{PP}	V _{IN} = 141V, I _o = 100mA *2
Conversion efficiency	η	70	82	–	%	V _{IN} = 141V, I _o = 200mA

*1 Maximum output current varies depending on ambient temperature; please refer to derating curve.

*2 Spike noise is not included in output ripple voltage.

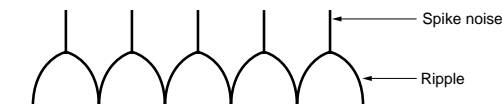

Power Module

●Pin descriptions

Pin No.	Pin name
1	V _{OUT}
3	COIL
5	COIL
7	COMMON
10	N.C.
12	V _{IN}

Pins 2, 4, 6, 8, 9, 11 are removed.

●Measurement circuit

BP5039-12

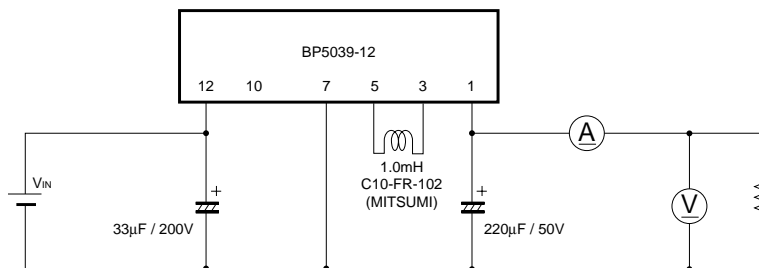

Fig.1

BP5039-15

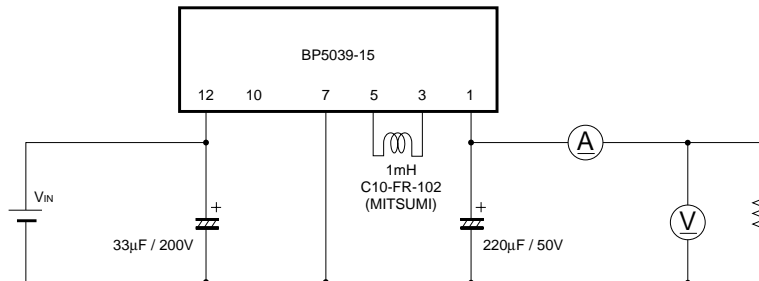

Fig.2

BP5039A

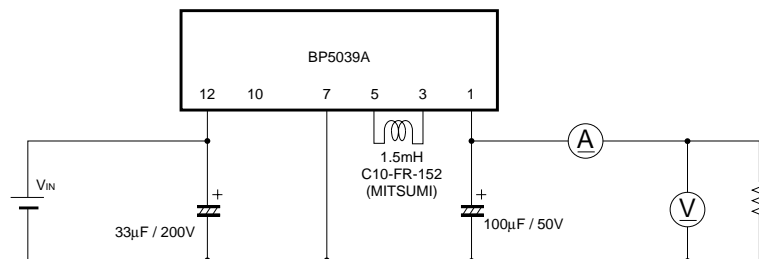

Fig.3

*Use a low-impedance product for switching power supplies for the output capacitor.

Power Module

●Application example

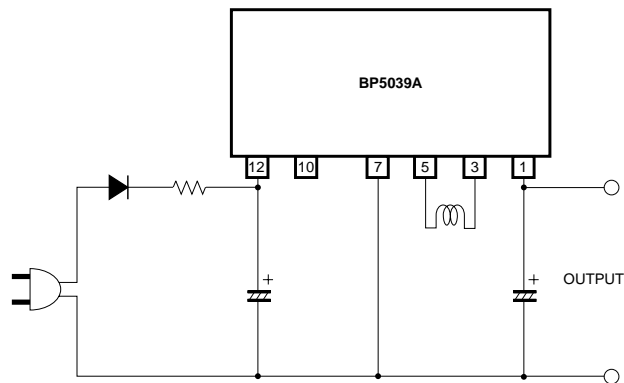
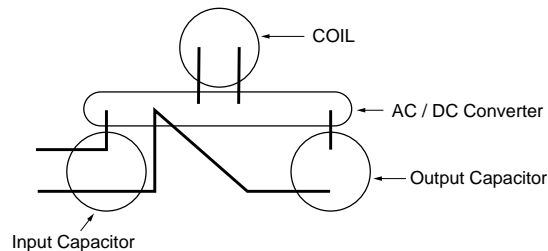

Fig.4

●Operation notes

- (1) The output current needs to be reduced as the ambient temperature rises. (Refer to derating curve.)
- (2) Over current and shorted circuit
If there is any danger of the load being shorted or over current being produced, always use a protective device such as a fuse.
- (3) Insulation
These products are not insulated on the primary and secondary sides, and there is a danger of electrical shock if they are touched.
- (4) Avoid subjecting these products to strong impact.
- (5) Lead pins should be securely soldered. If lead pins are not securely connected, irregular voltages could be produced, causing breakdowns and damage.
- (6) The parts arrangement should be made as shown in the following figure.



- (7) Soldering
It should be performed within 10 seconds at 260°C.
- (8) Soldering iron
The temperature of the tip of the soldering iron should be less than 310°C, and the soldering should be performed within 3 seconds.
- (9) Input voltage
Be careful so that the input voltage should not exceed the maximum input voltage. Further, since operation will be allowed even at the low voltage (about 40V), if operation at the low voltage is not required, cope with the situation by using an externally installed circuit.
- (10) Operating temperature
The operating temperature should necessarily be within the range of the temperature designated in the specification. Since the surface temperature increase of these products will change depending on the use environment, be minded to actually measure the temperature each time.

Power Module

(11) Smoothing capacitor for input pin

The capacitor should have a withstand voltage of at least 200V.

(12) Smoothing capacitor for output pin

The capacitor should have a withstand voltage of at least 25V. Capacitors designed for switching power supplies are especially suitable. In case that the general capacitors are used, be minded to use those of which allowable ripple current is 0.25Arms or more.

(13) Connections with other devices

Devices using the products should not be connected to other devices. If connected, insulation should be provided.

●Electrical characteristic curves

BP5039-12

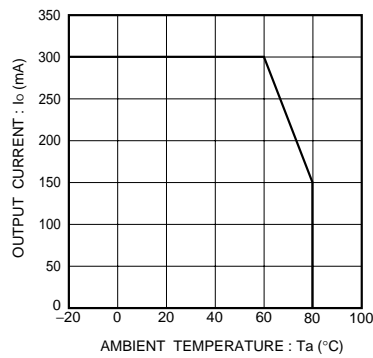

Fig.5 Derating curve

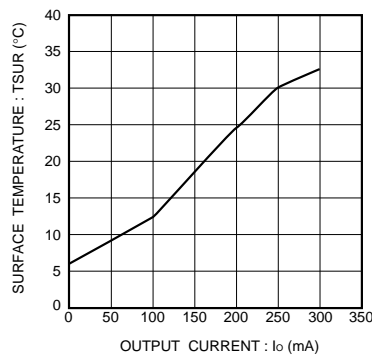

Fig.6 Surface temperature rise

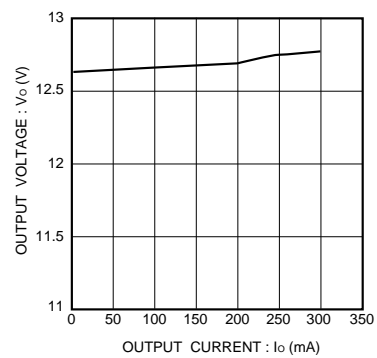

Fig.7 Output characteristic

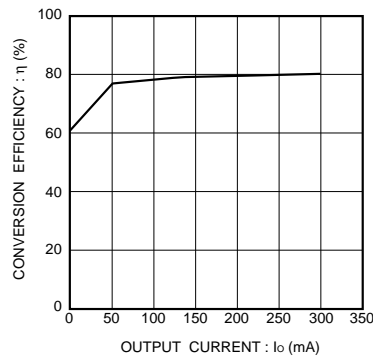

Fig.8 Conversion efficiency

Power Module

BP5039-15

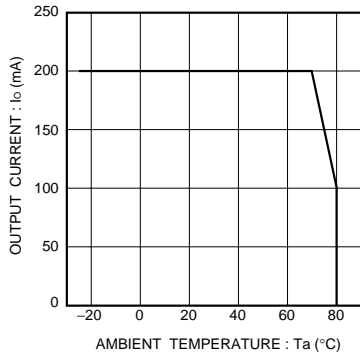

Fig.9 Derating curve

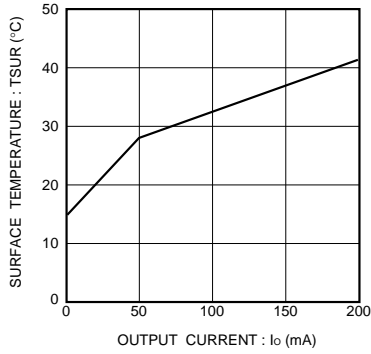

Fig.10 Surface temperature rise

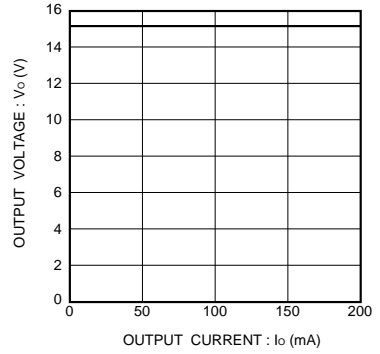

Fig.11 Output characteristic

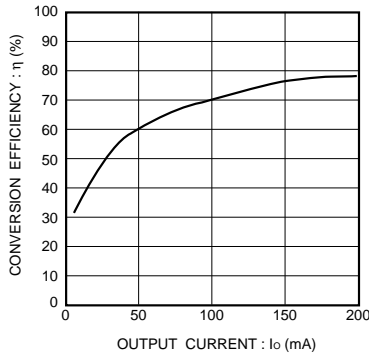

Fig.12 Conversion efficiency

BP5039A

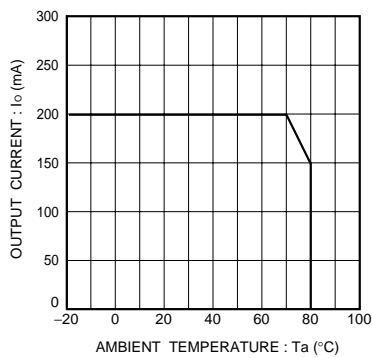

Fig.13 Derating curve

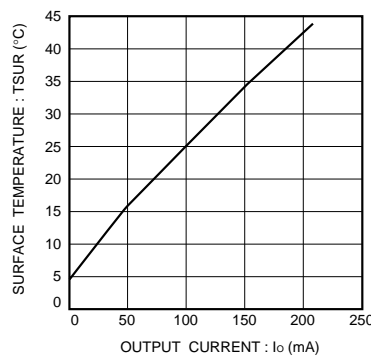

Fig.14 Surface temperature rise

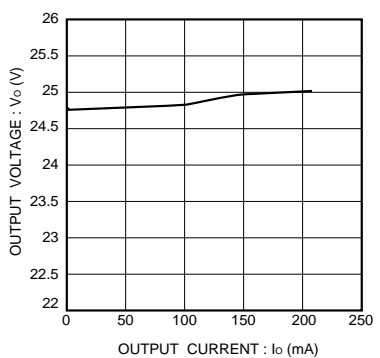

Fig.15 Output characteristic

Power Module

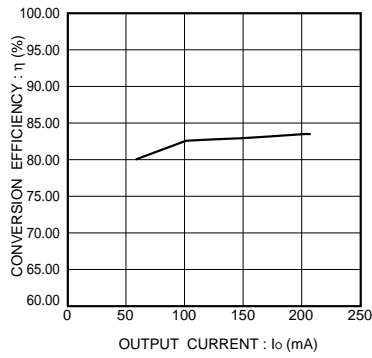
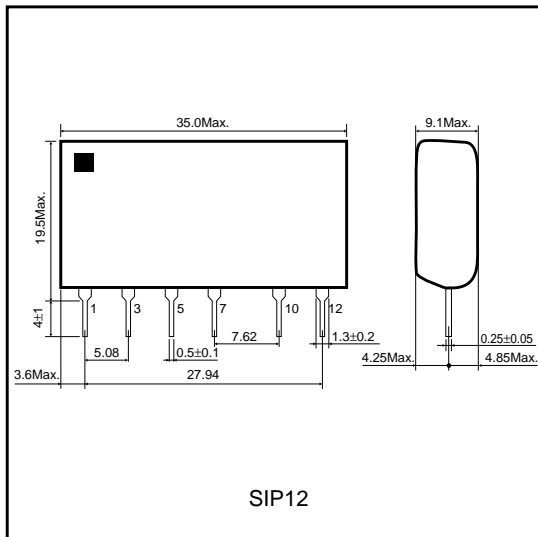

Fig.16 Conversion efficiency

●External dimensions (Units : mm)



Notes

- No technical content pages of this document may be reproduced in any form or transmitted by any means without prior permission of ROHM CO.,LTD.
- The contents described herein are subject to change without notice. The specifications for the product described in this document are for reference only. Upon actual use, therefore, please request that specifications to be separately delivered.
- Application circuit diagrams and circuit constants contained herein are shown as examples of standard use and operation. Please pay careful attention to the peripheral conditions when designing circuits and deciding upon circuit constants in the set.
- Any data, including, but not limited to application circuit diagrams information, described herein are intended only as illustrations of such devices and not as the specifications for such devices. ROHM CO.,LTD. disclaims any warranty that any use of such devices shall be free from infringement of any third party's intellectual property rights or other proprietary rights, and further, assumes no liability of whatsoever nature in the event of any such infringement, or arising from or connected with or related to the use of such devices.
- Upon the sale of any such devices, other than for buyer's right to use such devices itself, resell or otherwise dispose of the same, no express or implied right or license to practice or commercially exploit any intellectual property rights or other proprietary rights owned or controlled by
- ROHM CO., LTD. is granted to any such buyer.
- Products listed in this document use silicon as a basic material.
Products listed in this document are no antiradiation design.

The products listed in this document are designed to be used with ordinary electronic equipment or devices (such as audio visual equipment, office-automation equipment, communications devices, electrical appliances and electronic toys).

Should you intend to use these products with equipment or devices which require an extremely high level of reliability and the malfunction of which would directly endanger human life (such as medical instruments, transportation equipment, aerospace machinery, nuclear-reactor controllers, fuel controllers and other safety devices), please be sure to consult with our sales representative in advance.

About Export Control Order in Japan

Products described herein are the objects of controlled goods in Annex 1 (Item 16) of Export Trade Control Order in Japan.

In case of export from Japan, please confirm if it applies to "objective" criteria or an "informed" (by MITI clause) on the basis of "catch all controls for Non-Proliferation of Weapons of Mass Destruction.