

DC / DC converter unit

BP51L05 / BP51L12

The BP51L05 and BP51L12 are DC / DC converter units that use a pulse width modulation (PWM) system. They contain built-in control circuits, switching devices, rectifiers, and coils, and operate if only an I / O smoothing capacitor is connected. With a wide range of input voltage, the ICs are best suited for obtaining a stable local power source from a main power supply with a large voltage variation.

●Applications

Power supplies for copiers, personal computers, word processors, industrial equipment, and maintenance tools

●Features

- 1) Wide range of input voltage.
- 2) High power conversion efficiency.
- 3) Heat sink unnecessary.
- 4) Compact SIP 9-pin package.

●Absolute maximum ratings

Parameter	Symbol	Limits		Unit
		BP51L05	BP51L12	
Input voltage	V_i	24		V
Output current	I_o	0.1*		A
Operating temperature	T_{opr}	-15~+70		°C
Storage temperature	T_{stg}	-25~+85		°C

* Derating required according to ambient temperature.

●Electrical characteristics

- BP51L05 (unless otherwise noted, $V_i = 15V$, $I_o = 50mA$, and $T_a = 25^\circ C$)

Parameter	Symbol	Min.	Typ.	Max.	Unit	Conditions
Input voltage	V_i	8	—	20	V	
Output voltage	V_o	-5.3	-5	-4.7	V	
Output current	I_o	0.01	—	0.1	A	
Line regulation 1	ΔV_{o1}	—	3	30	mV	$V_i = 15V \sim 20V$
Line regulation 2	ΔV_{o2}	—	5	30	mV	$V_i = 8V \sim 15V$
Load regulation 1	ΔV_{o3}	—	3	30	mV	$I_o = 50mA \sim 100mA$
Load regulation 2	ΔV_{o4}	—	0	30	mV	$I_o = 10mA \sim 50mA$
Output ripple voltage	$\nu \gamma$	—	13	40	mV _{P-P}	Not including pulsation noise
Power conversion efficiency	η	30	50	—	%	
Switching frequency	f_{sw}	—	45	—	kHz	

- BP51L12 (unless otherwise noted, $V_i = 15V$, $I_o = 50mA$, and $T_a = 25^\circ C$)

Parameter	Symbol	Min.	Typ.	Max.	Unit	Conditions
Input voltage	V_i	8	—	20	V	
Output voltage	V_o	-12.8	-12	-11.2	V	
Output current	I_o	0.01	—	0.1	A	
Line regulation	ΔV_{o1}	—	20	80	mV	$V_i = 8V \sim 20V$
Load regulation	ΔV_{o2}	—	20	80	mV	$I_o = 10mA \sim 100mA$
Output ripple voltage	$\nu \gamma$	—	10	80	mV _{P-P}	Not including pulsation noise
Power conversion efficiency	η	40	60	—	%	
Switching frequency	f_{sw}	—	45	—	kHz	

●Block diagram and measurement circuit

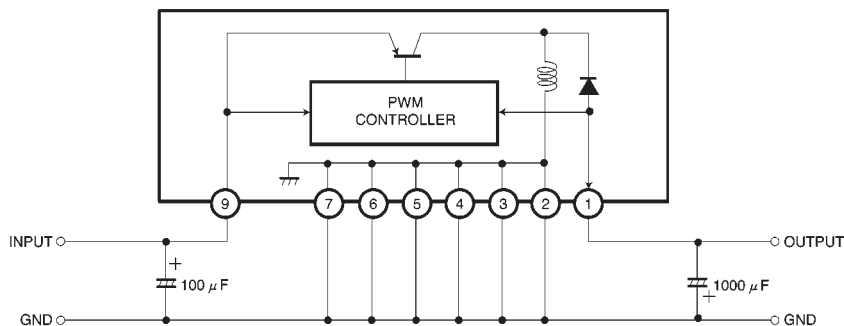

Electrolytic capacitor: TWSS series (Shinei Tsushin Kogyo)

● Pin descriptions

Pin No.	Pin name	Function
1	V_o	Output ; output smoothing capacitor with a recommended capacitance of $1000 \mu\text{F}$ is connected between this pin and GND
2~7	GND	Ground , which are all connected internally
9	V_i	Input ; input capacitor with a recommended capacitance of $100 \mu\text{F}$ is connected between this pin and GND

● Operation notes

(1) Reduce output current according to an increase in ambient temperature. Use the IC within the derating curve range.

(2) Sudden power increase at the input pin (pin 9) results in increased rush current, and may cause damage to the hybrid IC and overshooting of output voltage. Check for this problem, which is dependent on the rise time of input power supply and load conditions, in the actual application. As a guide, input power supply of 10ms or greater is required against rush current, and 100ms or greater against overshooting. Suppress the peak value of rush current to 2A or less.

(3) Pins 2 to 7 are ground pins that are connected to each other internally. Not all pins have to be used.

(4) The IC contains no circuit to protect the output current. If short circuit is feared, use the ICP or other protection measures.

● Electrical characteristic curves

● BP51L05

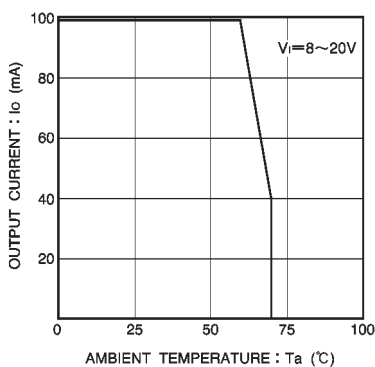

Fig.1 Derating curve

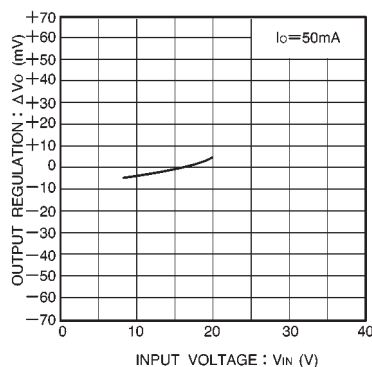

Fig.2 Output voltage variation vs. input voltage

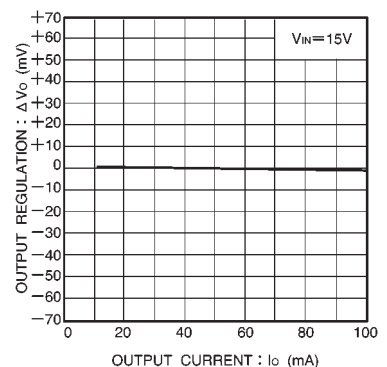

Fig.3 Output voltage variation vs. output current

●BP51L12

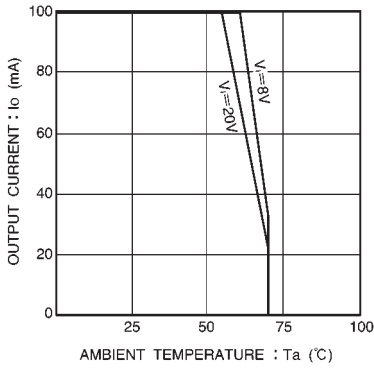

Fig.4 Derating curve

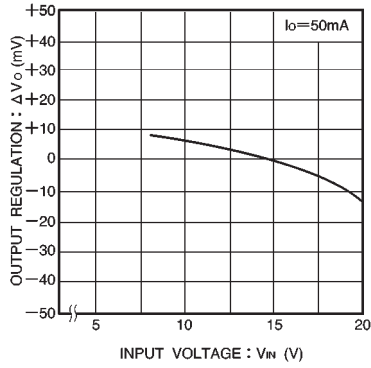

Fig.5 Output voltage variation vs. input voltage

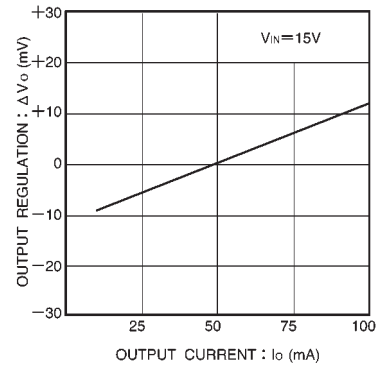

Fig.6 Output voltage variation vs. output current

●External dimensions (Units: mm)

