

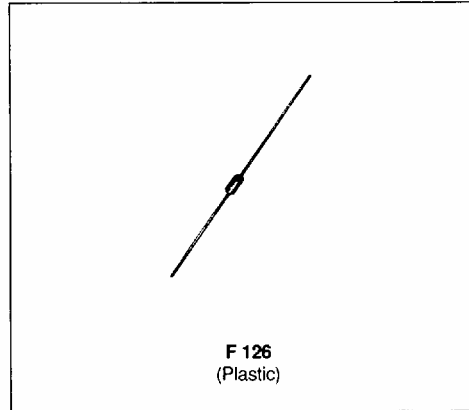

- VOLTAGE RANGE : 3.3V TO 200V
- HERMETICALLY SEALED PLASTIC CASE
- PACKAGE ACCORDING TO NORMALIZATION
CCTU : F 126
- PRO ELECTRON REGISTRATION
- HIGH SURGE CAPABILITY (55W @ 10ms)



DESCRIPTION

2W silicon Zener diodes.

ABSOLUTE RATINGS (limiting values)

Symbol	Parameter	Value	Unit
P_{tot}	Power Dissipation*	$T_{amb} = 55^{\circ}C$ 2	W
I_{ZM}	Continuous Reverse Current*	$T_{amb} = 55^{\circ}C$ See page 2	mA
I_{ZSM}	Peak Reverse Current	$T_{amb} = 25^{\circ}C$ See page 2	A
T_{stg} T_j	Storage and Junction Temperature Range	- 65 to 175	$^{\circ}C$
T_L	Maximum Lead Temperature for Soldering during 3s at 5mm from case	300	$^{\circ}C$

THERMAL RESISTANCE

Symbol	Parameter	Value	Unit
$R_{th(j-a)}$	Junction-ambient*	60	$^{\circ}C/W$

* On infinite heatsink with 10mm lead length

ELECTRICAL CHARACTERISTICS ($T_{amb} = 25^{\circ}\text{C}$ unless otherwise specified)

Types	V_{ZT}/I_{ZT}		r_{ZT}/I_{ZT}	I_{ZT}	αV_Z	I_R/V_R	V_R	I_{ZM}	I_{ZSM}
	min	max	max	(mA)	typ	max	(V)	$T_{amb} = 55^{\circ}\text{C}$	(A)
	(V)		(Ω)	(mA)	($10^{-4}/^{\circ}\text{C}$)	(μA)	(V)	(mA)	(A)
	(1)		(1)	(1)				(2)	(3)
BZV 47 C 3V3	3.1	3.5	10	100	-6.0			570	12.1
BZV 47 C 3V6	3.4	3.8	10	100	-5.5			525	11.1
BZV 47 C 3V9	3.7	4.1	7	100	-5.0			485	10.3
BZV 47 C 4V3	4.0	4.6	7	100	-4.0			435	9.2
BZV 47 C 4V7	4.4	5.0	7	100	-2.0			400	8.5
P BZV 47 C 5V1	4.8	5.4	5	100	1.0			370	7.8
P BZV 47 C 5V6	5.2	6.0	2	100	2.5	5	1	330	7.1
P BZV 47 C 6V2	5.8	6.6	2	100	3.2	5	1	300	6.4
P BZV 47 C 6V8	6.4	7.2	2	100	4.0	5	1	275	5.9
BZV 47 C 7V5	7.0	7.9	2	100	4.5	5	2	250	5.4
BZV 47 C 8V2	7.7	8.7	2	100	4.8	5	3.5	230	4.9
BZV 47 C 9V1	8.5	9.6	4	50	5.1	5	3.5	205	4.4
BZV 47 C 10	9.4	10.6	4	50	5.5	5	7.6	185	4.0
BZV 47 C 11	10.4	11.6	7	50	6.0	1	8.3	170	3.6
P BZV 47 C 12	11.4	12.7	7	50	6.5	1	9.1	155	3.3
BZV 47 C 13	12.4	14.1	10	50	6.5	1	9.9	140	3.0
P BZV 47 C 15	13.8	15.6	10	50	7.0	1	11.4	130	2.7
BZV 47 C 16	15.3	17.1	15	25	7.0	0.5	12.2	115	2.5
P BZV 47 C 18	16.8	19.1	15	25	7.5	0.5	13.7	105	2.2
P BZV 47 C 20	18.8	21.2	15	25	7.5	0.5	15.2	94	2.0
P BZV 47 C 22	20.8	23.3	15	25	8.0	0.5	16.7	86	1.8
P BZV 47 C 24	22.8	25.6	15	25	8.0	0.5	18.2	78	1.7
P BZV 47 C 27	25.1	28.9	15	25	8.5	0.5	20.5	69	1.5
P BZV 47 C 30	28	32	15	25	8.5	0.5	22.8	62	1.3
BZV 47 C 33	31	35	15	25	8.5	0.5	25	57	1.2
P BZV 47 C 36	34	38	40	10	8.5	0.5	27.4	52	1.1
BZV 47 C 39	37	41	40	10	9.0	0.5	29.6	48	1.0
BZV 47 C 43	40	46	45	10	9.0	0.5	32.7	43	0.92
P BZV 47 C 47	44	50	45	10	9.0	0.5	35.7	40	0.85
BZV 47 C 51	48	54	60	10	9.0	0.5	38.8	37	0.78
BZC 47 C 56	52	60	60	10	9.0	0.5	42.5	33	0.71
P BZV 47 C 62	58	66	80	10	9.0	0.5	47.1	30	0.64
P BZV 47 C 68	64	72	80	10	9.0	0.5	51.7	27	0.59
BZV 47 C 75	70	79	100	10	9.0	0.5	57	25	0.53
BZV 47 C 82	77	87	100	10	9.0	0.5	62.4	23	0.49
BZV 47 C 91	85	96	200	5	9.0	0.5	69.2	20	0.44
P BZV 47 C 100	94	106	200	5	9.0	0.5	76	18	0.40
BZV 47 C 110	104	116	250	5	9.5	0.5	83.5	17	0.36
BZV 47 C 120	114	127	250	5	9.5	0.5	91.2	15	0.33
P BZV 47 C 130	124	141	300	5	9.5	0.5	98.2	14	0.30
P BZV 47 C 150	138	156	300	5	9.5	0.5	114	12.8	0.27
BZV 47 C 160	153	171	350	5	9.5	0.5	122	11.7	0.25
BZV 47 C 180	168	191	350	5	9.5	0.5	137	10.5	0.22
P BZV 47 C 200	188	212	350	5	9.5	0.5	152	9.4	0.20

(1) Pulse test $t_p \leq 50\text{ms}$ $\delta < 2\%$

(2) On infinite heatsink $d = 10\text{mm}$

(3) Rectangular waveform ($t_p = 10\text{ms}$)

The regulation voltages are defined according to the E24 series

P Preferred voltages

Forward voltage drop $V_F \leq 1.2\text{V}$ ($T_{amb} = 25^{\circ}\text{C}$, $I_F = 500\text{mA}$)

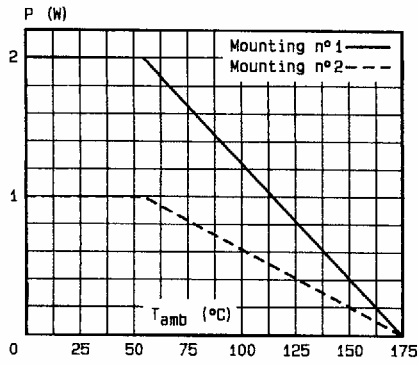

Fig.1 - Power dissipation versus ambient temperature.

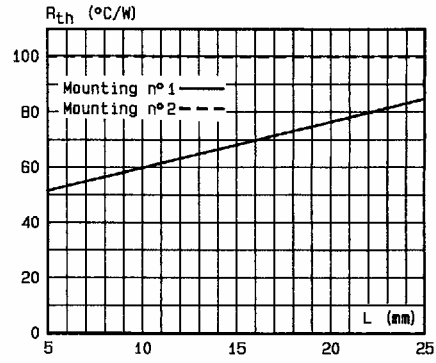

Fig.2 - Thermal resistance versus lead length.

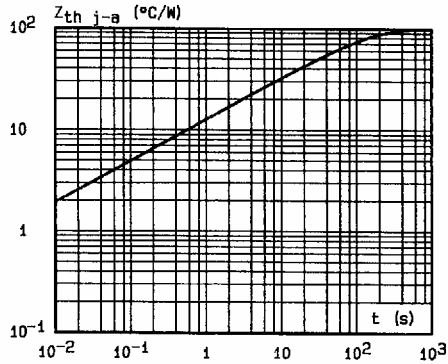

Fig.3 - Transient thermal impedance junction-ambient for mounting n°2 versus pulse duration ($L = 10$ mm).

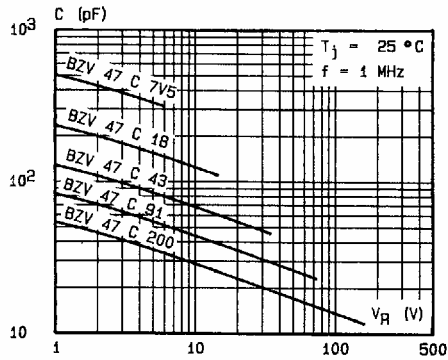

Fig.4 - Capacitance versus reverse applied voltage.

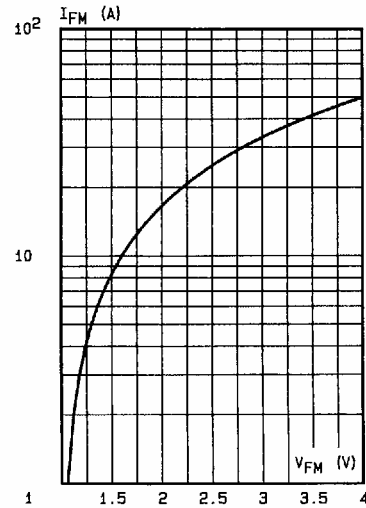
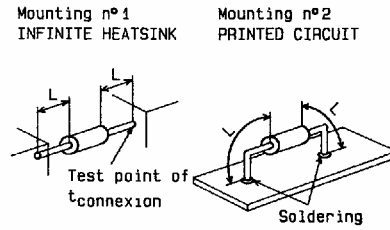

Fig.5 - Peak forward current versus peak forward voltage drop (typical values).

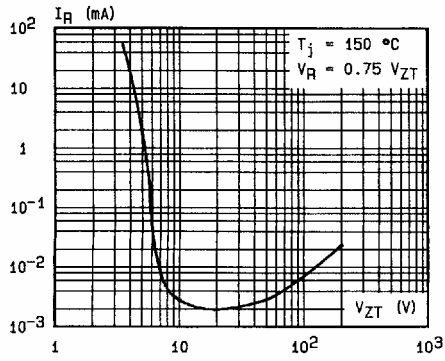

Fig.6 - Reverse current versus regulation voltage (typical values).

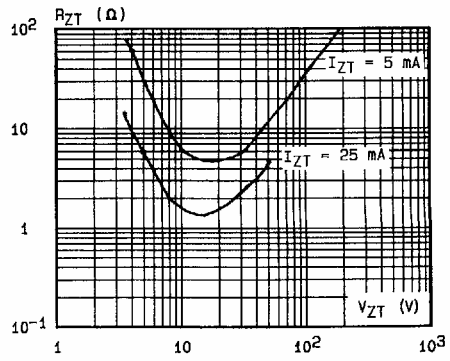

Fig.7 - Differential resistance versus regulation voltage (typical values).

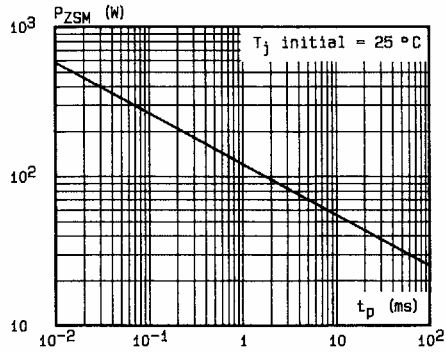
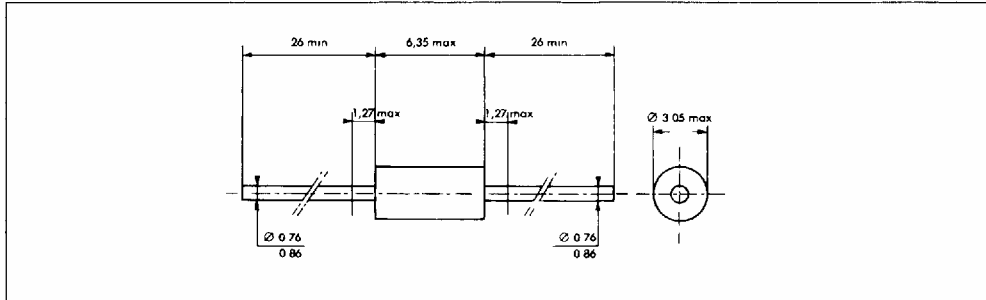

Fig.8 - Peak pulse power versus pulse duration (rectangular wave form) (maximum values).

PACKAGE MECHANICAL DATA

F 126 (Plastic)



Cooling method by convection (method A)
 Marking clear ring at cathode end
 Weight 0.4g