

XPT™ 600V IGBT GenX3™ w/ Diode

IXXH75N60B3D1

Extreme Light Punch Through
IGBT for 5-30 kHz Switching



$$V_{CES} = 600V$$

$$I_{C110} = 75A$$

$$V_{CE(sat)} \leq 1.85V$$

$$t_{fi(typ)} = 125ns$$

| Symbol | Test Conditions | Maximum Ratings | |
|-------------------------------|---|---|------------|
| | | | |
| V_{CES} | $T_J = 25^\circ C$ to $175^\circ C$ | 600 | V |
| V_{CGR} | $T_J = 25^\circ C$ to $175^\circ C$, $R_{GE} = 1M\Omega$ | 600 | V |
| V_{GES} | Continuous | ± 20 | V |
| V_{GEM} | Transient | ± 30 | V |
| I_{C25} | $T_C = 25^\circ C$ | 160 | A |
| I_{C110} | $T_C = 110^\circ C$ | 75 | A |
| I_{F110} | $T_C = 110^\circ C$ | 30 | A |
| I_{CM} | $T_C = 25^\circ C$, 1ms | 300 | A |
| I_A | $T_C = 25^\circ C$ | 30 | A |
| E_{AS} | $T_C = 25^\circ C$ | 500 | mJ |
| SSOA (RBSOA) | $V_{GE} = 15V$, $T_{VJ} = 150^\circ C$, $R_G = 5\Omega$ Clamped Inductive Load | $I_{CM} = 150$ @ $V_{CE} \leq V_{CES}$ | A |
| t_{sc} (SCSOA) | $V_{GE} = 15V$, $V_{CE} = 360V$, $T_J = 150^\circ C$ $R_G = 22\Omega$, Non Repetitive | 10 | μs |
| P_C | $T_C = 25^\circ C$ | 750 | W |
| T_J | | -55 ... +175 | $^\circ C$ |
| T_{JM} | | 175 | $^\circ C$ |
| T_{stg} | | -55 ... +175 | $^\circ C$ |
| T_L | Maximum Lead Temperature for Soldering | 300 | $^\circ C$ |
| T_{SOLD} | 1.6 mm (0.062in.) from Case for 10s | 260 | $^\circ C$ |
| M_d | Mounting Torque | 1.13/10 | Nm/lb.in. |
| Weight | | 6 | g |

TO-247 AD

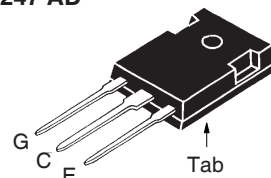

G = Gate C = Collector
E = Emitter Tab = Collector

Features

- Optimized for 5-30kHz Switching
- Square RBSOA
- Anti-Parallel Ultra Fast Diode
- Avalanche Capability
- Short Circuit Capability
- International Standard Package

Advantages

- High Power Density
- 175 $^\circ C$ Rated
- Extremely Rugged
- Low Gate Drive Requirement

Applications

- Power Inverters
- UPS
- Motor Drives
- SMPS
- PFC Circuits
- Battery Chargers
- Welding Machines
- Lamp Ballasts

| Symbol | Test Conditions ($T_J = 25^\circ C$, Unless Otherwise Specified) | Characteristic Values | | |
|---------------|---|-----------------------|--------------|--------------------|
| | | Min. | Typ. | Max. |
| BV_{CES} | $I_C = 250\mu A$, $V_{GE} = 0V$ | 600 | | V |
| $V_{GE(th)}$ | $I_C = 250\mu A$, $V_{CE} = V_{GE}$ | 3.0 | | 5.5 V |
| I_{CES} | $V_{CE} = V_{CES}$, $V_{GE} = 0V$ $T_J = 150^\circ C$ | | | 25 μA 3 mA |
| I_{GES} | $V_{CE} = 0V$, $V_{GE} = \pm 20V$ | | | ± 100 nA |
| $V_{CE(sat)}$ | $I_C = 60A$, $V_{GE} = 15V$, Note 1 $T_J = 150^\circ C$ | | 1.60 2.00 | 1.85 V V |

| Symbol Test Conditions ($T_J = 25^\circ\text{C}$ Unless Otherwise Specified) | | Characteristic Values | | | |
|--|---|-----------------------|------|---------------------------|----|
| | | Min. | Typ. | Max. | |
| g_{fs} | $I_C = 60\text{A}, V_{CE} = 10\text{V}$, Note 1 | 20 | 32 | S | |
| C_{ies} | $V_{CE} = 25\text{V}, V_{GE} = 0\text{V}, f = 1\text{MHz}$ | | 3290 | pF | |
| C_{oes} | | | 195 | pF | |
| C_{res} | | | 63 | pF | |
| $Q_{g(on)}$ | $I_C = 75\text{A}, V_{GE} = 15\text{V}, V_{CE} = 0.5 \cdot V_{CES}$ | | 107 | nC | |
| Q_{ge} | | | 30 | nC | |
| Q_{gc} | | | 48 | nC | |
| $t_{d(on)}$ | Inductive load, $T_J = 25^\circ\text{C}$ $I_C = 60\text{A}, V_{GE} = 15\text{V}$ $V_{CE} = 400\text{V}, R_G = 5\Omega$ Note 2 | | 35 | ns | |
| t_{ri} | | | 75 | ns | |
| E_{on} | | | 1.7 | mJ | |
| $t_{d(off)}$ | | | 118 | 160 | ns |
| t_{fi} | | | 125 | ns | |
| E_{off} | | | 1.5 | 2.1 | mJ |
| $t_{d(on)}$ | Inductive load, $T_J = 150^\circ\text{C}$ $I_C = 60\text{A}, V_{GE} = 15\text{V}$ $V_{CE} = 400\text{V}, R_G = 5\Omega$ Note 2 | | 36 | ns | |
| t_{ri} | | | 72 | ns | |
| E_{on} | | | 2.6 | mJ | |
| $t_{d(off)}$ | | | 145 | ns | |
| t_{fi} | | | 170 | ns | |
| E_{off} | | | 2.2 | mJ | |
| R_{thJC} | | | 0.20 | $^\circ\text{C}/\text{W}$ | |
| R_{thCS} | | 0.21 | | $^\circ\text{C}/\text{W}$ | |

TO-247 (IXXH) Outline

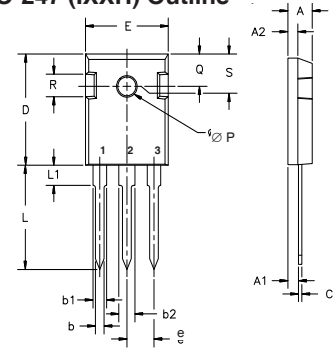

Terminals: 1 - Gate 2 - Collector
3 - Emitter

| Dim. | Millimeter | | Inches | |
|----------------|------------|-------|--------|-------|
| | Min. | Max. | Min. | Max. |
| A | 4.7 | 5.3 | .185 | .209 |
| A ₁ | 2.2 | 2.54 | .087 | .102 |
| A ₂ | 2.2 | 2.6 | .059 | .098 |
| b | 1.0 | 1.4 | .040 | .055 |
| b ₁ | 1.65 | 2.13 | .065 | .084 |
| b ₂ | 2.87 | 3.12 | .113 | .123 |
| C | .4 | .8 | .016 | .031 |
| D | 20.80 | 21.46 | .819 | .845 |
| E | 15.75 | 16.26 | .610 | .640 |
| e | 5.20 | 5.72 | 0.205 | 0.225 |
| L | 19.81 | 20.32 | .780 | .800 |
| L1 | | 4.50 | | .177 |
| ∅P | 3.55 | 3.65 | .140 | .144 |
| Q | 5.89 | 6.40 | 0.232 | 0.252 |
| R | 4.32 | 5.49 | .170 | .216 |
| S | 6.15 | BSC | .242 | BSC |

Reverse Diode (FRED)

| Symbol Test Conditions ($T_J = 25^\circ\text{C}$ Unless Otherwise Specified) | | Characteristic Values | | |
|--|---|---------------------------|------|-------------------------------|
| | | Min. | Typ. | Max. |
| V_F | $I_F = 30\text{A}, V_{GE} = 0\text{V}$, Note 1 | | | 2.7 V |
| | | $T_J = 150^\circ\text{C}$ | 1.6 | V |
| I_{RM} | $I_F = 30\text{A}, V_{GE} = 0\text{V}, -di_F/dt = 100\text{A}/\mu\text{s}$ | $T_J = 100^\circ\text{C}$ | | 4 A |
| t_{rr} | $V_R = 100\text{V}$ | $T_J = 100^\circ\text{C}$ | 100 | ns |
| | $I_F = 1\text{A}, V_{GE} = 0\text{V}, -di_F/dt = 100\text{A}/\mu\text{s}, V_R = 30\text{V}$ | | 25 | ns |
| R_{thJC} | | | | 0.9 $^\circ\text{C}/\text{W}$ |

Notes:

1. Pulse test, $t \leq 300\mu\text{s}$, duty cycle, $d \leq 2\%$.
2. Switching times & energy losses may increase for higher V_{CE} (clamp), T_J or R_G .

IXYS Reserves the Right to Change Limits, Test Conditions, and Dimensions.

| | | | | | | | | | | |
|--|-----------|-----------|-----------|-----------|--------------|--------------|--------------|--------------|--------------|-------------|
| IXYS MOSFETs and IGBTs are covered by one or more of the following U.S. patents: | 4,835,592 | 4,931,844 | 5,049,961 | 5,237,481 | 6,162,665 | 6,404,065 B1 | 6,683,344 | 6,727,585 | 7,005,734 B2 | 7,157,338B2 |
| | 4,860,072 | 5,017,508 | 5,063,307 | 5,381,025 | 6,259,123 B1 | 6,534,343 | 6,710,405 B2 | 6,759,692 | 7,063,975 B2 | |
| | 4,881,106 | 5,034,796 | 5,187,117 | 5,486,715 | 6,306,728 B1 | 6,583,505 | 6,710,463 | 6,771,478 B2 | 7,071,537 | |

Fig. 1. Output Characteristics @ $T_J = 25^\circ\text{C}$

Fig. 2. Extended Output Characteristics @ $T_J = 25^\circ\text{C}$

Fig. 3. Output Characteristics @ $T_J = 150^\circ\text{C}$

Fig. 4. Dependence of $V_{CE(sat)}$ on Junction Temperature

Fig. 5. Collector-to-Emitter Voltage vs. Gate-to-Emitter Voltage

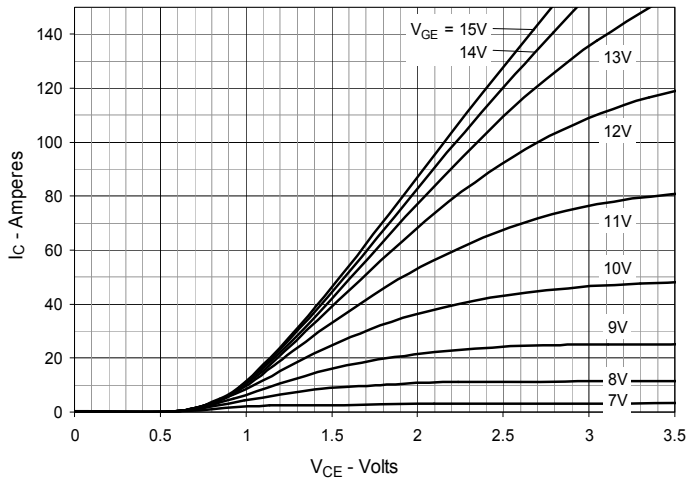
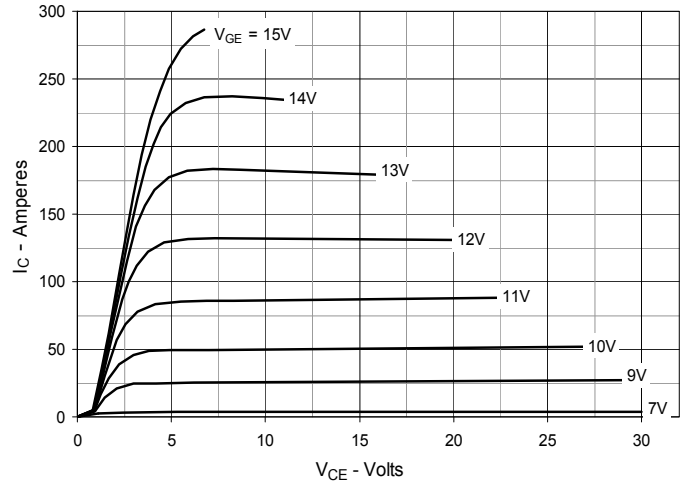
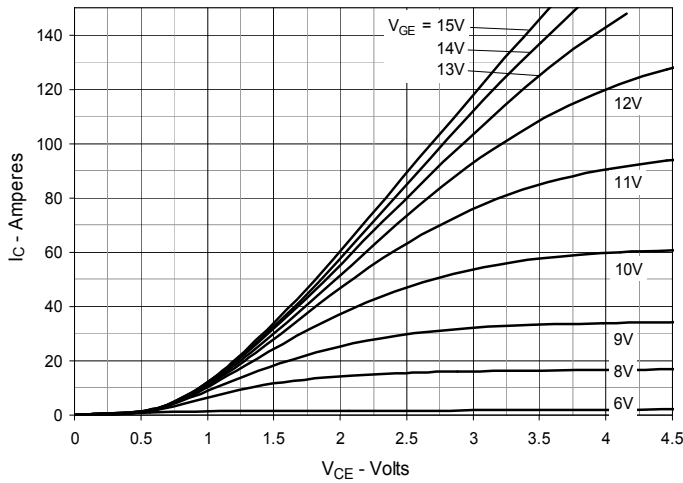
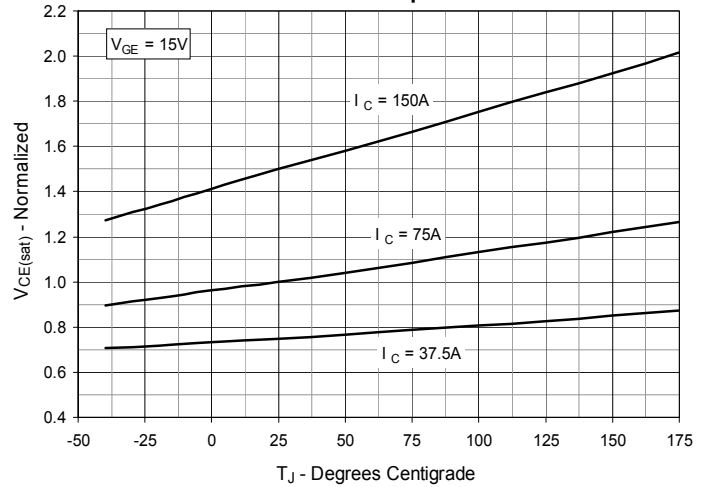
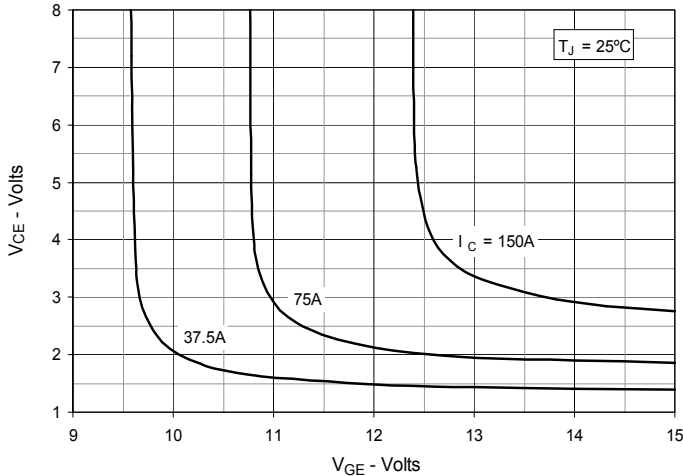
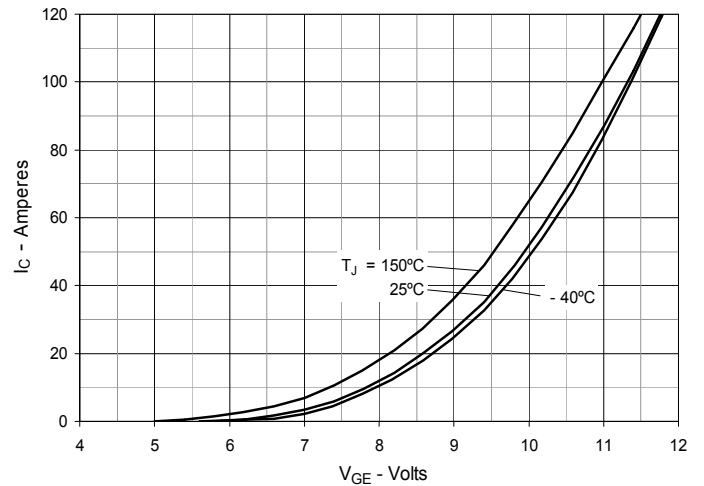
Fig. 6. Input Admittance

Fig. 7. Transconductance

Fig. 8. Gate Charge

Fig. 9. Capacitance

Fig. 10. Reverse-Bias Safe Operating Area

Fig. 11. Maximum Transient Thermal Impedance

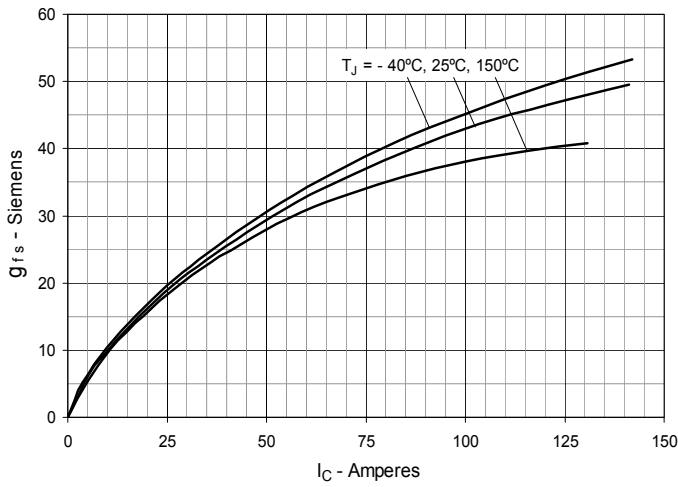
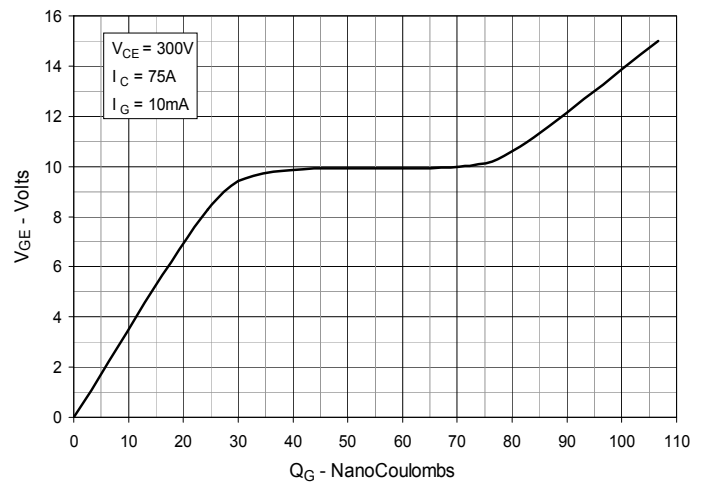
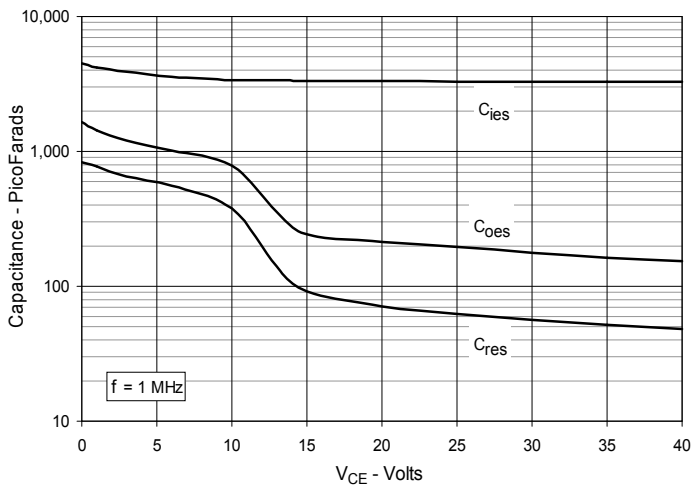
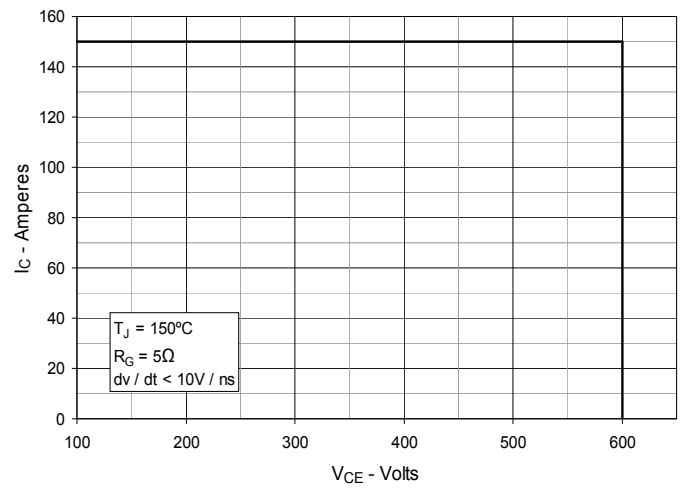
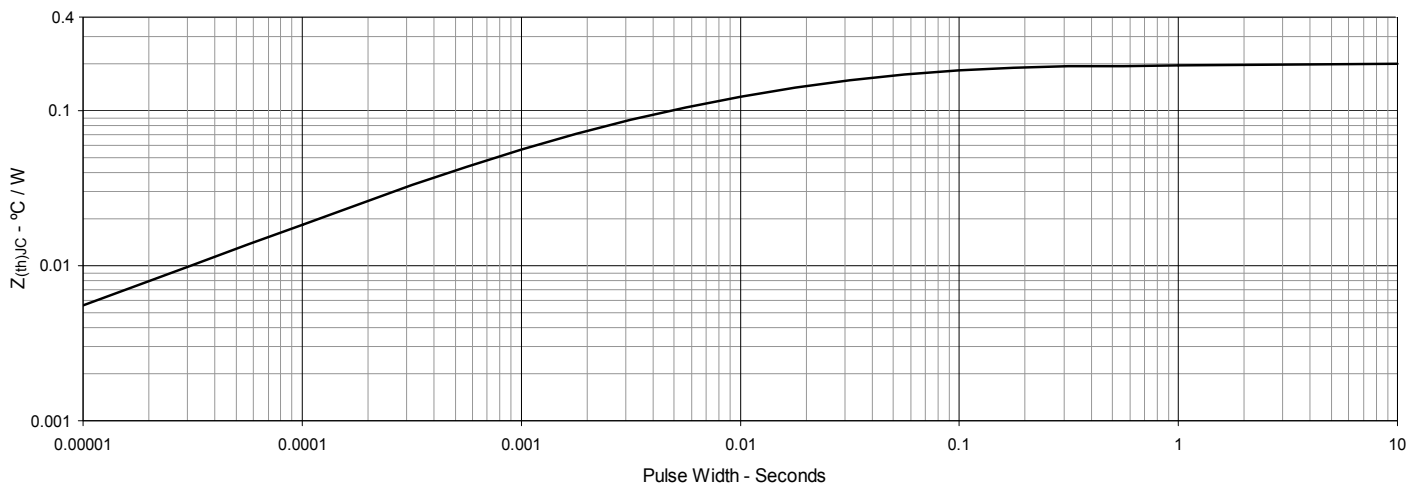
Fig. 12. Inductive Switching Energy Loss vs. Gate Resistance

Fig. 13. Inductive Switching Energy Loss vs. Collector Current

Fig. 14. Inductive Switching Energy Loss vs. Junction Temperature

Fig. 15. Inductive Turn-off Switching Times vs. Gate Resistance

Fig. 16. Inductive Turn-off Switching Times vs. Collector Current

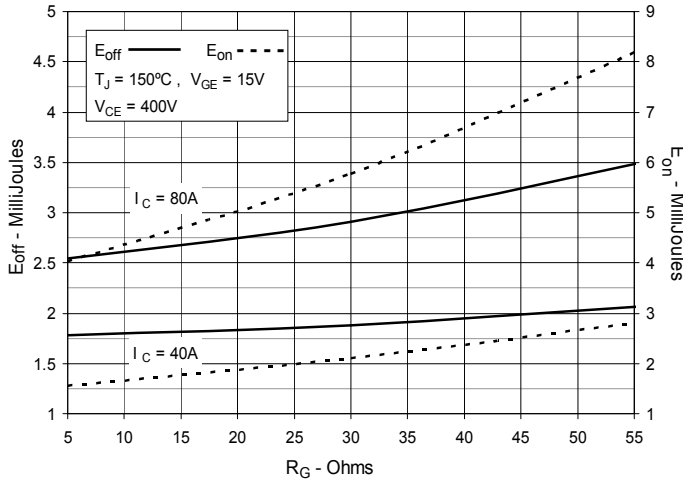
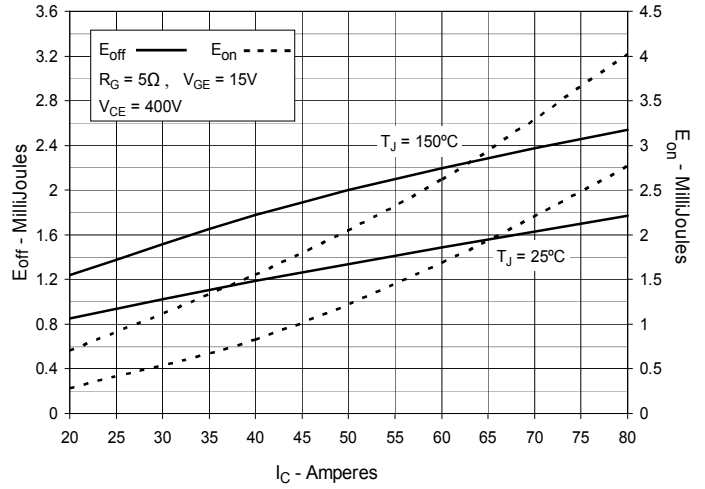
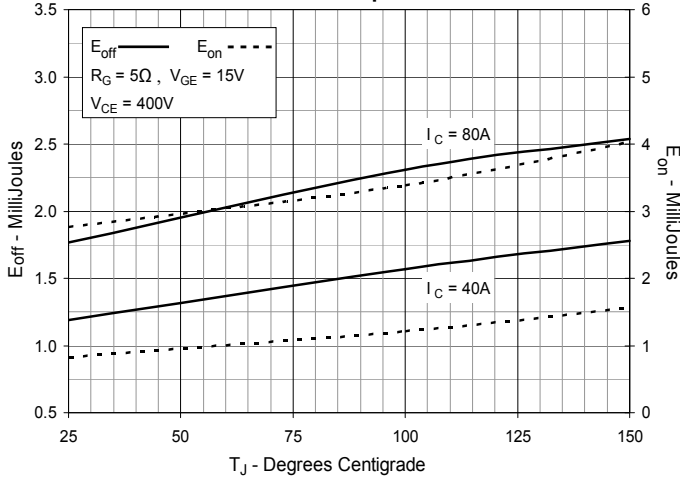
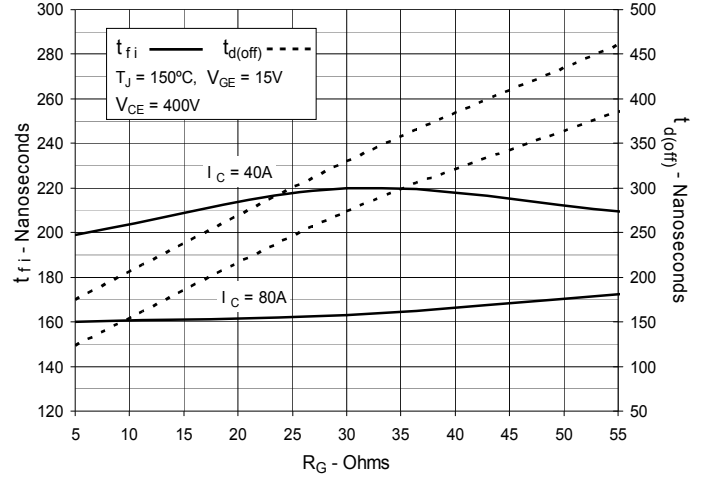
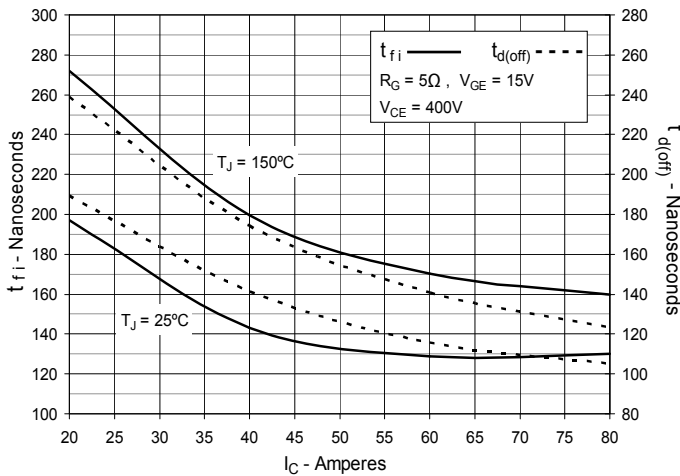
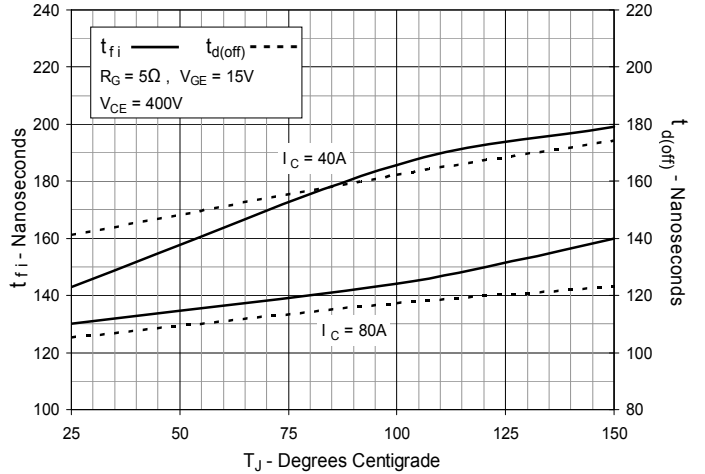
Fig. 17. Inductive Turn-off Switching Times vs. Junction Temperature

Fig. 18. Inductive Turn-on Switching Times vs. Gate Resistance

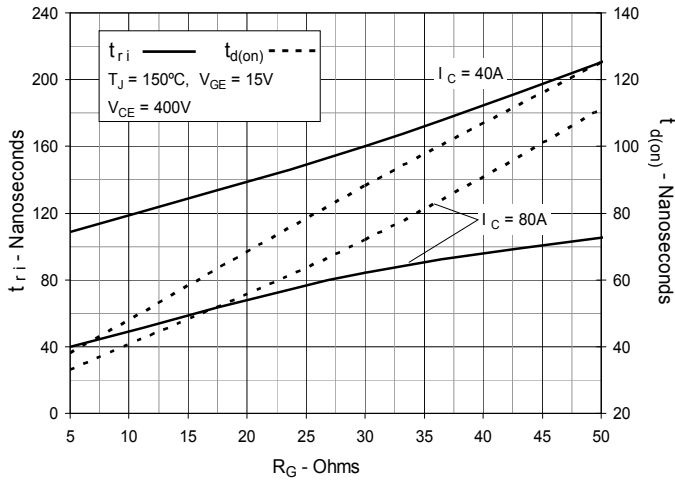

Fig. 19. Inductive Turn-on Switching Times vs. Collector Current

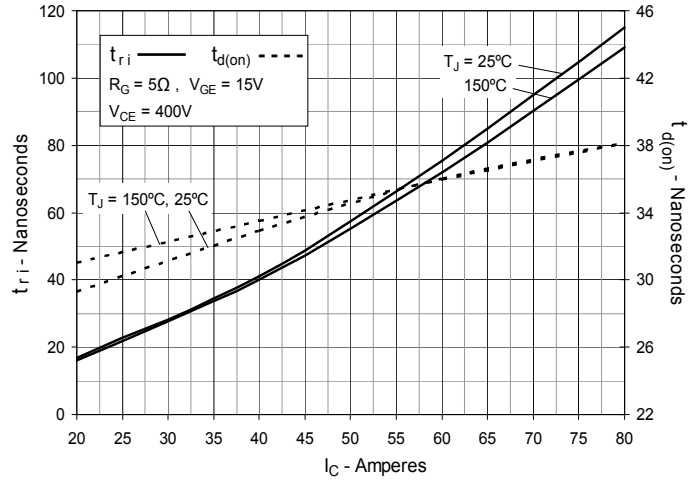
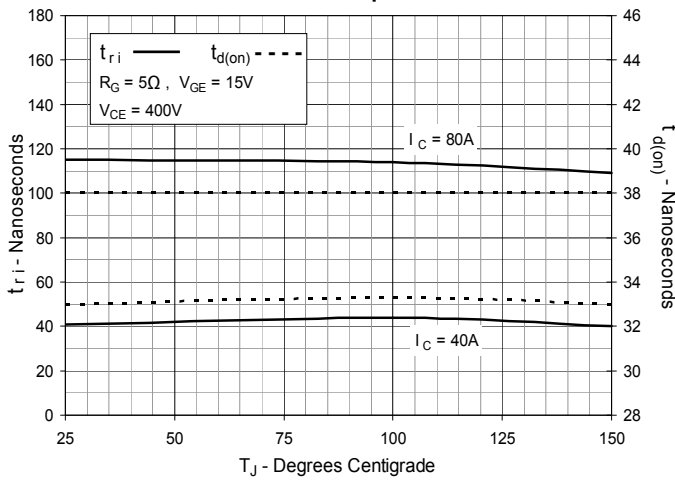

Fig. 20. Inductive Turn-on Switching Times vs. Junction Temperature



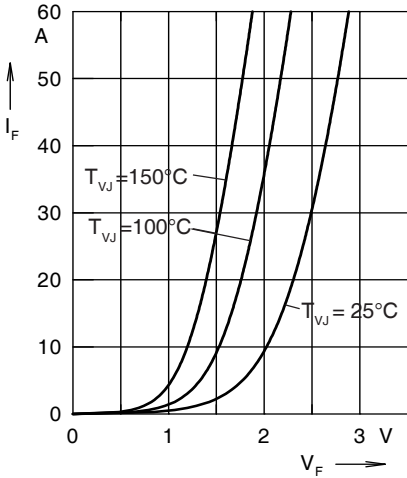
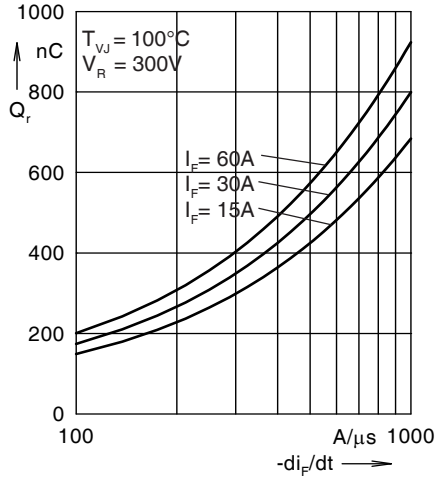
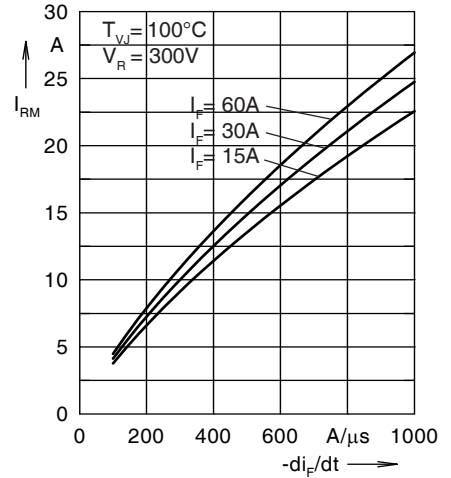
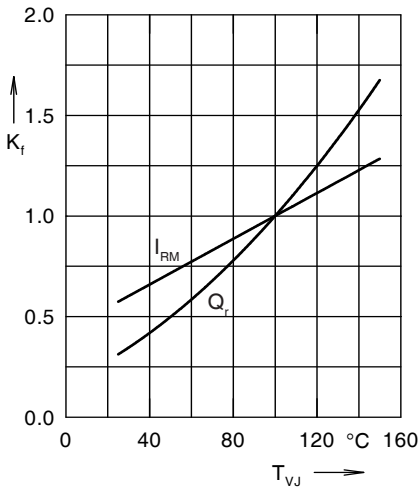
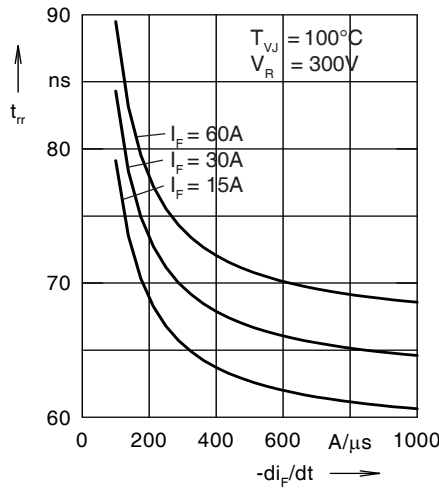
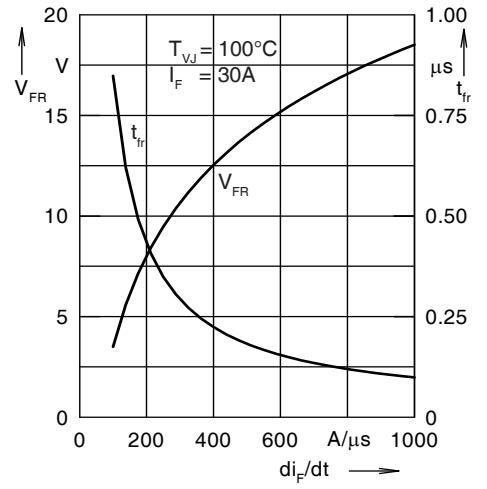

 Fig. 21. Forward Current I_F Versus V_F

 Fig. 22. Reverse Recovery Charge Q_r Versus $-di_F/dt$

 Fig. 23. Peak Reverse Current I_{RM} Versus $-di_F/dt$

 Fig. 24. Dynamic Parameters Q_r , I_{RM} Versus T_{VJ}

 Fig. 25. Recovery Time t_{rr} Versus $-di_F/dt$

 Fig. 26. Peak Forward Voltage V_{FR} and t_{fr} Versus di_F/dt

Fig. 27. Transient Thermal Resistance Junction to Case

 Constants for Z_{thJC} calculation:

| i | R_{thi} (K/W) | t_i (s) |
|---|-----------------|-----------|
| 1 | 0.502 | 0.0052 |
| 2 | 0.193 | 0.0003 |
| 3 | 0.205 | 0.0162 |