

M611x Series

5 x 7 mm, 3.0, 3.3 & 5.0 Volt, HCMOS or Clipped Sinewave,
Precision TCXO/TCVTCXO

Product Features

- Tight stability (0.3 ppm) over wide industrial temperature range (-40 °C to +85 °C)
- 3.0 V, 3.3 V and 5.0 V versions
- Wide frequency range 8-52 MHz
- Low phase noise
- Excellent G-Sensitivity performance: 1.5 ppb/G
- Tri-state Function



Product Description

MtronPTI's M611x Series TCXO's and TCVTCXO's provide design engineers with low voltage, surface mount products with extremely tight stability (to ± 0.3 ppm) over temperature and time. Specially processed crystals enable the M611x to achieve consistent long-term stability and minimal frequency shift after reflow. Our processing also enables us to achieve excellent g-sensitivity (1.5 ppb/g). The low phase noise (-155 dBc/Hz at 100 kHz) makes the M611x ideal for those design engineers working on all types of systems as the reference timing source.

Product Applications

The M611x Series is ideally suited for a wide range of applications such as GPS, military, avionics, test and measurement, WLAN, WiMax base stations (see Fig 2.), point to point/multi-point radios, medical equipment, frequency synthesis, frequency translation and land mobile radio. Standard output for the M611x series is HCMOS compatible or clipped sinewave and draws as little as 1.5 mA with a 3.3 volt supply at 13 MHz. This low power consumption provides an advantage over similarly specified ovenized oscillators for power-sensitive applications. The M611x series offers ± 9.2 ppm minimum pull range with excellent tuning linearity performance for critical PLL applications. This series is available in frequencies from 8 to 52 MHz, and is offered in a ceramic surface mount platform with industry standard 5 x 7 mm footprint.

Product Ordering Information

Ordering Information		M611x	1	J	T	C	N	00.0000 MHz
Product Series								
M6110:	5.0 V							
M6111:	3.3 V							
M6112:	3.0 V							
Temperature Range								
1:	0°C to +70°C							
2:	-40°C to +85°C							
6:	-20°C to +70°C							
8:	0°C to +50°C							
F:	-30°C to +75°C							
Stability								
P:	± 0.3 ppm							
G:	± 0.5 ppm							
J:	± 1.0 ppm							
K:	± 2.0 ppm							
H:	± 2.5 ppm							
Output Type								
T:	Voltage Controlled With Tristate (VCTCXO)							
F:	No Voltage Control With Tristate (TCXO)							
Output Waveform								
C:	HCMOS							
S:	Clipped Sine Wave							
Package/Lead Configurations								
N:	Leadless Ceramic							
Frequency (customer specified)								

M6110Sxxx, M6111Sxxx & M6112Sxxx - Contact factory for datasheets.

M611x Series

5 x 7 mm, 3.0, 3.3 & 5.0 Volt, HCMOS or Clipped Sinewave,
Precision TCXO/TCVTCXO

Performance Characteristics

Parameter	Symbol	Min.	Typ.	Max.	Units	Conditions/Notes
Frequency Range	F _O	8		52	MHz	
Operating Temperature	T _A	-40		+85	°C	See Ordering Information
Storage Temperature	T _{STG}	-55		+125	°C	
Frequency Tolerance @ +25°C		-1.0		+1.0	ppm	For TCXO only
Frequency Stability						See Ordering Information
Stability Vs. Reflow		-1.0		+1.0	ppm	
Frequency Vs. Supply			±0.2		ppm	For 10% supply voltage variation
Frequency Vs. Load			±0.2		ppm	For 10% load variation
Aging (First Year)		-1.0		+1.0	ppm	F ₀ ≤ 20 MHz
Aging (First Year)		-2.0		+2.0	ppm	F ₀ ≥ 20 MHz
Aging (10 Year)		-3.0		+3.0	ppm	F ₀ ≤ 20 MHz (Includes first year)
Aging (10 Year)		-5.0		+5.0	ppm	F ₀ ≥ 20 MHz (Includes first year)
Supply Voltage Tolerance		-5.0		+5.0	%	See Ordering Information
Supply Current (I _D)			2.2	3.3	mA	HCMOS output at 13 MHz
			3.5	5.0	mA	HCMOS output at 26 MHz
			6.0	9.2	mA	HCMOS output at 52 MHz
			1.5	2.2	mA	Clipped sinewave output at 13 MHz
			1.8	2.7	mA	Clipped sinewave output at 26 MHz
			3.0	4.5	mA	Clipped sinewave output at 52 MHz
Output Logic Levels (HCMOS)	V _{OL} V _{OH}	80		20	%V _S %V _S	I _{OH} /I _{OL} = ± 4 mA, V _S = +3.0 V I _{OH} /I _{OL} = ± 4 mA, V _S = +3.0 V
Output Level (Clipped Sinewave)		1.0			V _{pk-pk} V _{pk-pk}	F ₀ ≤ 40 MHz F ₀ > 40 MHz
Waveform Symmetry		40		60	%	Ref. to ½ V _S . HCMOS only
Rise/Fall Time				8	ns	Ref. 10% to 90%. HCMOS only
Output Load			15		pF	HCMOS output
			10/10		Kohm/pF	Clipped sinewave output
Frequency Adjustment		±9.2			ppm	Over Control Voltage Range
Control Voltage Range		0.3		2.7	Volts	For V _S = 3.0
		0.3		3.0	Volts	For V _S = 3.3
		0.5		4.5	Volts	For V _S = 5.0
Input Leakage Current		-50		+50	µA	Pad 10
Input Resistance		100			Kohm	Pad 10
Linearity				3	%	
Modulation Bandwidth		2 kHz				Pad 10
Tristate Function (Pad 8)		70			%V _S	Output enabled. Logic "1" or "Open"
				30	%V _S	Output disabled. Logic "0" or "GND"
Tristate Leakage Current		-100		+100	µA	Pad 8
Phase Noise (Typical 10 MHz CMOS)			-95		dBc/Hz	10 Hz Offset
			-125		dBc/Hz	100 Hz Offset
			-145		dBc/Hz	1 KHz Offset
			-152		dBc/Hz	10 KHz Offset
			-155		dBc/Hz	100 kHz Offset
Environmental	Shock	MIL-STD-202, Method 213, Condition C				100 g
	Vibration	MIL-STD-202, Methods 201 & 204				10 g from 10 to 2000 Hz
	Solderability	EIAJ-STD-002				
	Package	5.0 x 7.0 x 2.0 mm, 10-pad SMT				RoHS Compliant
	Max Soldering Conditions	See solder profile, Figure 1				

HCMOS Load – see load circuit diagram #2. Sinewave Load – see load circuit diagram #7.

Phase Noise Plot

M611x 10MHz Phase Noise

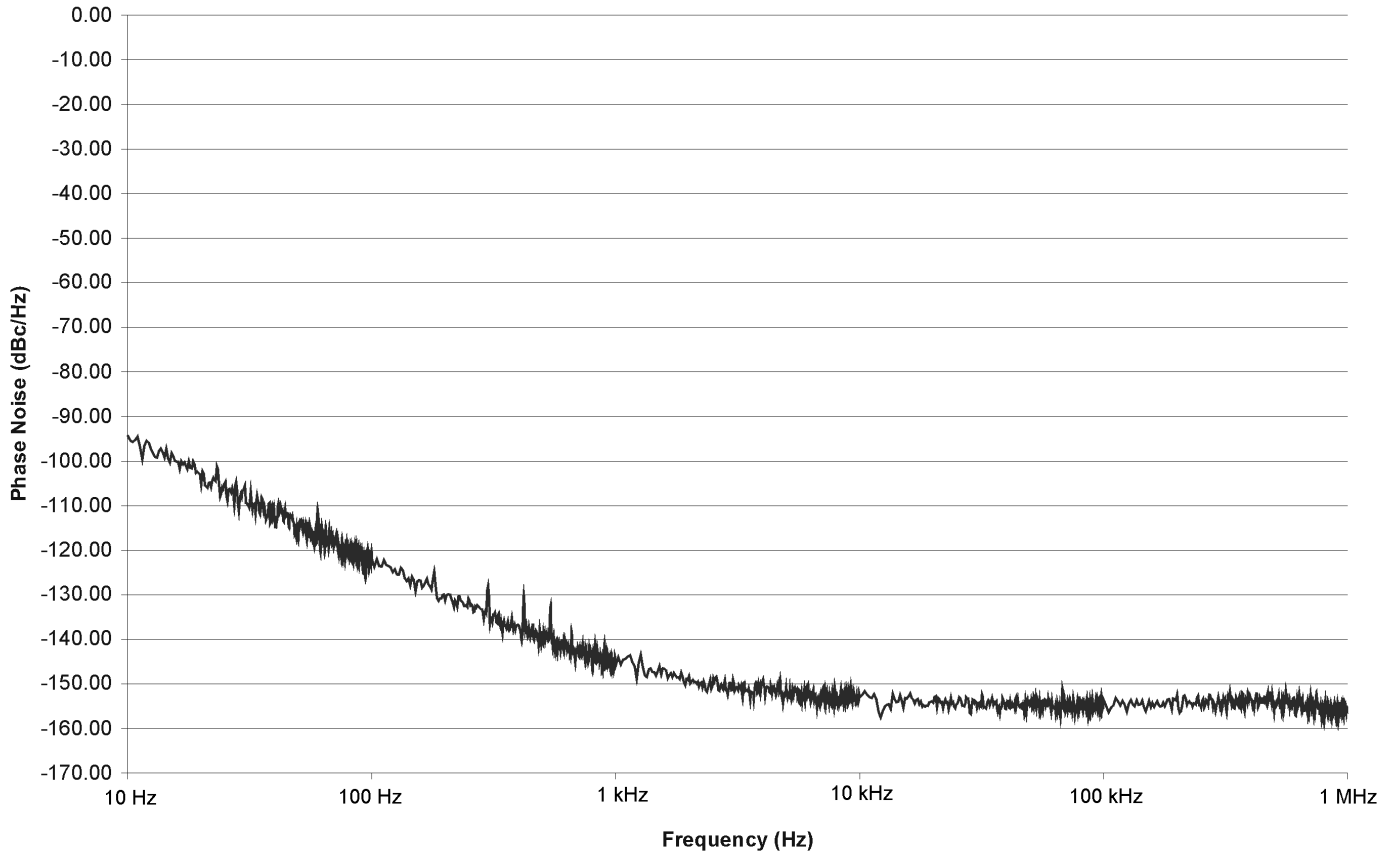

Output Waveform

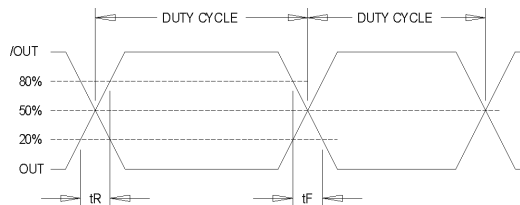

Product Dimension & Pinout Information

Pin Connections	
Function	Pad
Vref or N/C	1
N/C	2
N/C	3
Ground	4
Output	5
N/C	6
N/C	7
Tristate	8
Supply Voltage (V _s)	9
Control Voltage	10

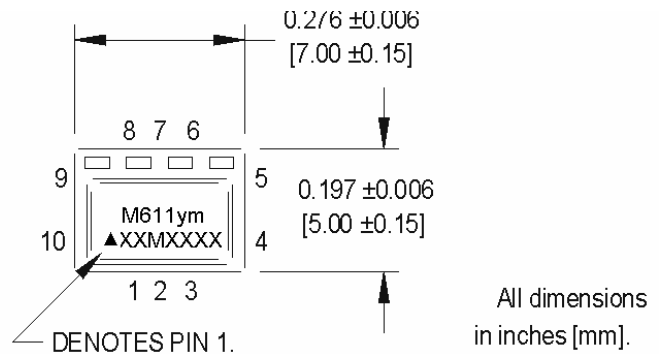

Part Markings:
Line 1: Indicates part family,
year, month of production
Line 2: Indicates frequency

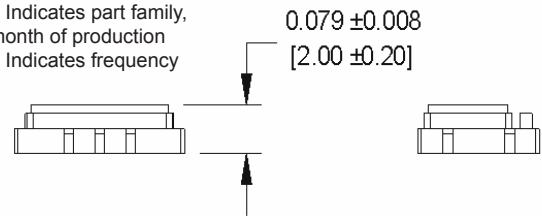

SUGGESTED SOLDER PAD LAYOUT

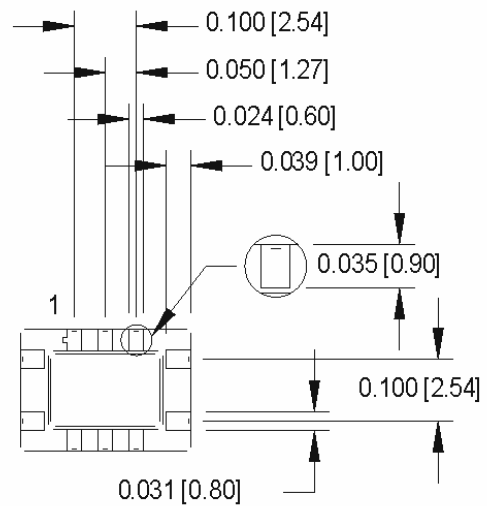
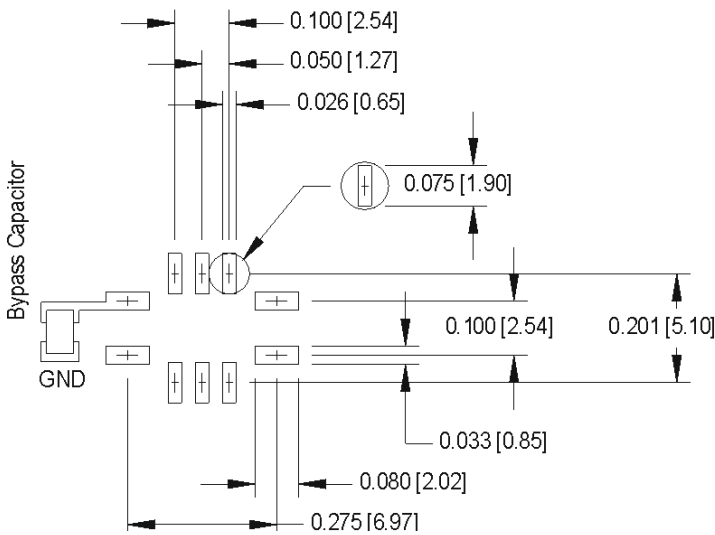

M611x Series

5 x 7 mm, 3.0, 3.3 & 5.0 Volt, HCMOS or Clipped Sinewave,
Precision TCXO/TCVTCXO

Handling Information

Although protection circuitry has been designed into the M611x oscillator, proper precautions should be taken to avoid exposure to electrostatic discharge (ESD) during handling and mounting. MtronPTI utilizes a human-body model (HBM) and a charged-device model (CDM) for ESD-susceptibility testing and protection design evaluation. ESD voltage thresholds are dependent on the circuit parameters used to define the mode. Although no industry-wide standard has been adopted for the CDM, a standard HBM (resistance = 1500 Ω , capacitance = 100 pF) is widely used and therefore can be used for comparison purposes. The HBM ESD threshold presented here was obtained using these circuit parameters.

Model	ESD Threshold, Minimum	Unit
Human Body	1500*	V
Charged Device	1500*	V

* MIL-STD-883D, Method 3015, Class 1



Quality Parameters

Environmental Specifications/Qualification Testing Performed on the M611x TCXO/TCVTCXO		
Test	Test Method	Test Condition
Electrical Characteristics	Internal Specification	Per Specification
Frequency vs. Temperature	Internal Specification	Per Specification
Mechanical Shock	MIL-STD-202, Method 213, C	100 g, 6 ms
Vibration	MIL-STD-202, Method 201-204	10 g from 10-2000 Hz
Thermal Cycle	MIL-STD-883, Method 1010, B	-55 Deg. C to +125 Deg. C, 15 minute Dwell, 10 cycles
Aging	Internal Specification	168 Hours at 105 Degrees C
Gross Leak	MIL-STD-202, Method 112	30 Second Immersion
Fine Leak	MIL-STD-202, Method 112	Must meet 1×10^{-5}
Solderability	MIL-STD-883, Method 2003	8 Hour Steam Age – Must Exhibit 95% coverage
Resistance to Solvents	MIL-STD-883, Method 2015	Three 1 minute soaks
Terminal Pull	MIL-STD-883, Method 2004, A	2 Pounds
Lead Bend	MIL-STD-883, Method 2004, B1	1 Bending Cycle
Physical Dimensions	MIL-STD-883, Method 2016	Per Specification
Internal Visual	Internal Specification	Per Internal Specification

Part Marking Guide

Line 1: Indicates part family, year, month of production

Line 2: Indicates frequency

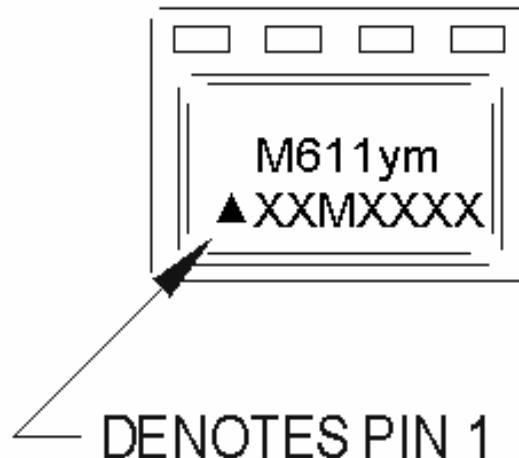

M611x Series

5 x 7 mm, 3.0, 3.3 & 5.0 Volt, HCMOS or Clipped Sinewave, Precision TCXO/TCVTCXO

Tape & Reel Specifications

(all measurements are in mm)	A	B	C	D	E	F	G	H	J	K	L	M	N
M611x	5.40	7.40	1.55	7.50	2.60	2.00	4.00	16.00	330	13.00	20.20	100	16.40

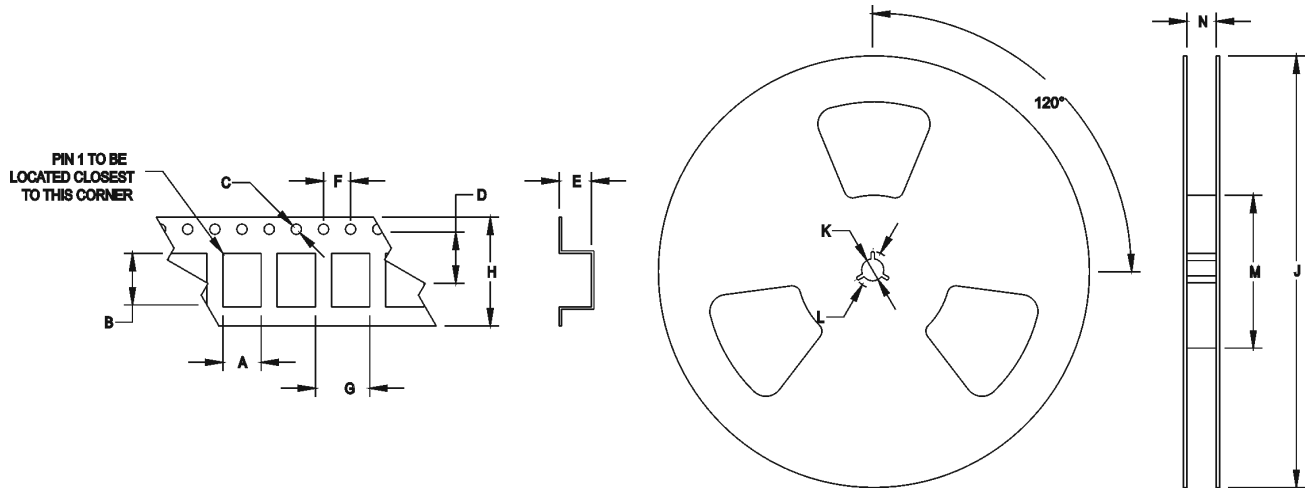

Standard Tape and Reel: 1000 parts per reel

Maximum Soldering Conditions

+260°C REFLOW PROFILE (RoHS COMPLIANT SOLDER)

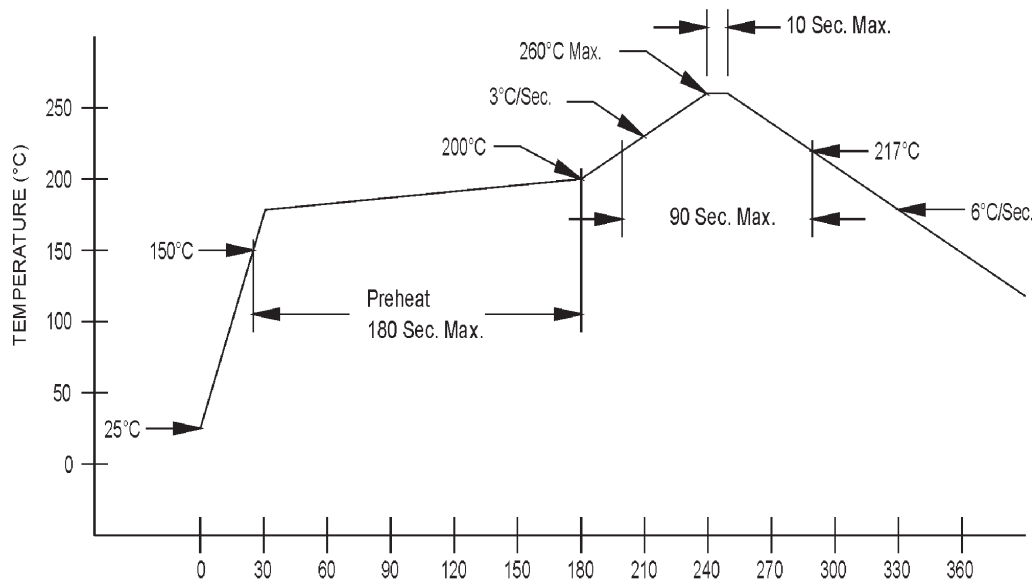

Solder Conditions

Note: Exceeding these limits may damage the device.

M611x Series

5 x 7 mm, 3.0, 3.3 & 5.0 Volt, HCMOS or Clipped Sinewave, Precision TCXO/TCVTCXO

Typical Test Circuit

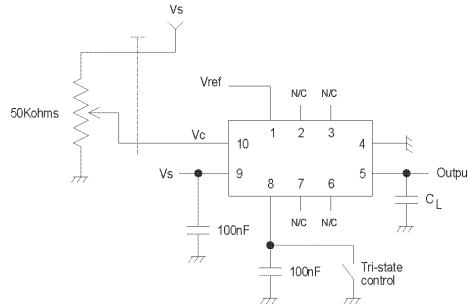

Load Circuit

Load Circuit #2 - HCMOS

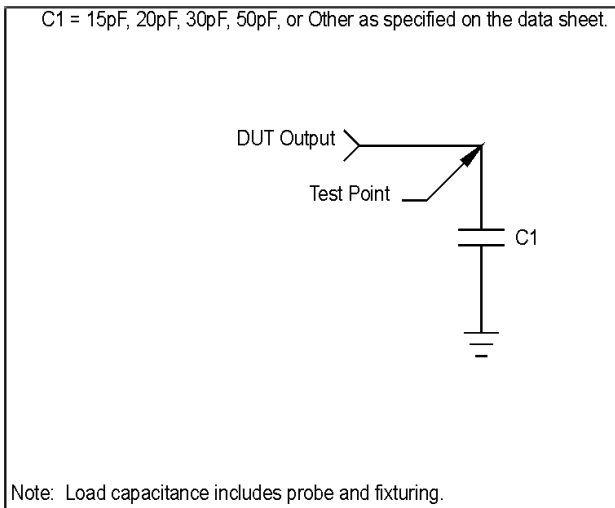

Load Circuit #7 - Clipped Sinewave TCXO/TCVTCXO

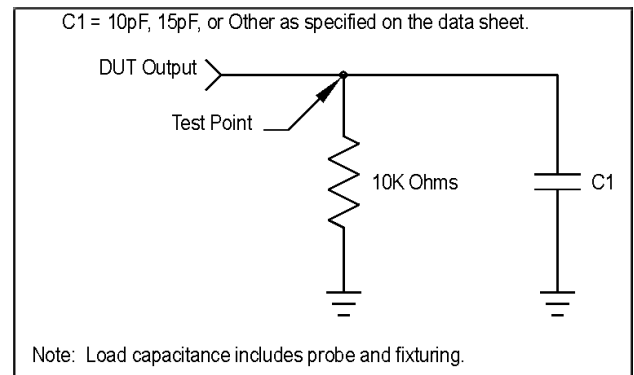

Product Revision Table

Date	Revision	PCN Number	Details of Revision

For custom products or additional specifications contact our sales team at
800.762.8800 (toll free) or 605.665.9321

For more information on this product visit the MtronPTI website at
www.mtronpti.com