

Features

- Schottky Barrier Chip
- Guard Ring Die Construction for Transient Protection
- High Current Capability
- Low Power Loss, High Efficiency
- High Surge Current Capability
- For Use in Low Voltage, High Frequency Inverters, Free Wheeling, and Polarity Protection Applications

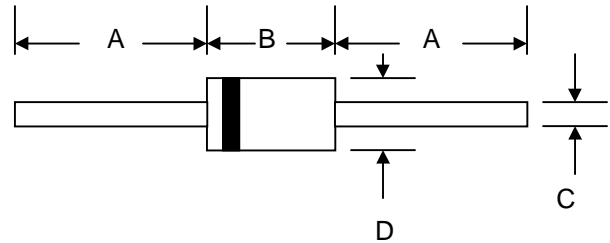

Mechanical Data

- Case: DO-201AD, Molded Plastic
- Terminals: Plated Leads Solderable per MIL-STD-202, Method 208
- Polarity: Cathode Band
- Weight: 1.2 grams (approx.)
- Mounting Position: Any
- Marking: Type Number
- **Lead Free: For RoHS / Lead Free Version, Add "-LF" Suffix to Part Number, See Page 4**

DO-201AD		
Dim	Min	Max
A	25.4	—
B	7.20	9.50
C	1.20	1.30
D	4.80	5.30
All Dimensions in mm		

Maximum Ratings and Electrical Characteristics @ $T_A=25^\circ\text{C}$ unless otherwise specified

Single Phase, half wave, 60Hz, resistive or inductive load.
For capacitive load, derate current by 20%.

Characteristic	Symbol	SB520	SB530	SB540	SB550	SB560	SB580	SB5100	Unit
Peak Repetitive Reverse Voltage	V_{RRM}								V
Working Peak Reverse Voltage	V_{RWM}	20	30	40	50	60	80	100	
DC Blocking Voltage	V_R								
RMS Reverse Voltage	$V_{R(RMS)}$	14	21	28	35	42	56	70	V
Average Rectified Output Current @ $T_L = 100^\circ\text{C}$ (Note 1)	I_O	5.0							A
Non-Repetitive Peak Forward Surge Current 8.3ms Single half sine-wave superimposed on rated load (JEDEC Method)	I_{FSM}	150							A
Forward Voltage @ $I_F = 5.0\text{A}$	V_{FM}	0.55		0.70		0.85		V	
Peak Reverse Current @ $T_A = 25^\circ\text{C}$ At Rated DC Blocking Voltage @ $T_A = 100^\circ\text{C}$	I_{RM}	0.5 50							mA
Typical Junction Capacitance (Note 2)	C_j	500			400			pF	
Typical Thermal Resistance (Note 1)	$R_{\theta JA}$	10							$^\circ\text{C/W}$
Operating and Storage Temperature Range	T_j, T_{STG}	-65 to +150							$^\circ\text{C}$

Note: 1. Valid provided that leads are kept at ambient temperature at a distance of 9.5mm from the case.
2. Measured at 1.0 MHz and applied reverse voltage of 4.0V D.C.

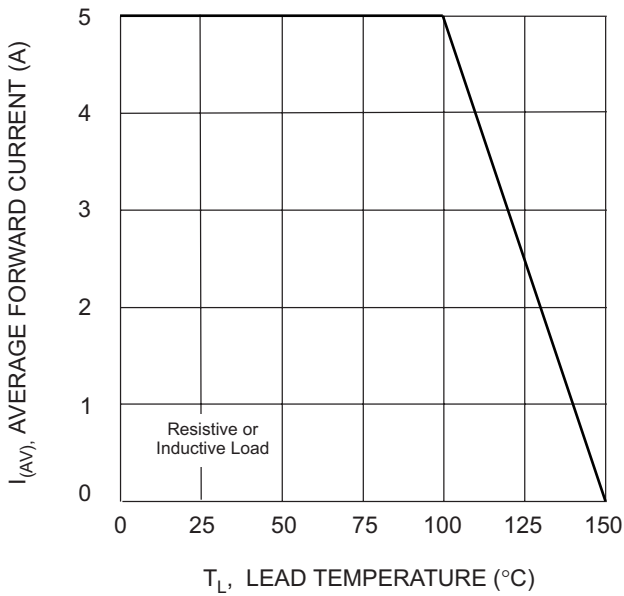

Fig. 1 Forward Current Derating Curve

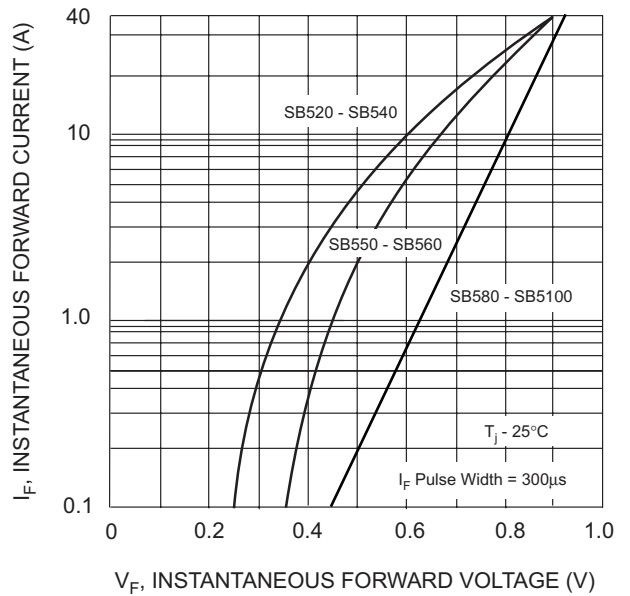

Fig. 2 Typical Forward Characteristics

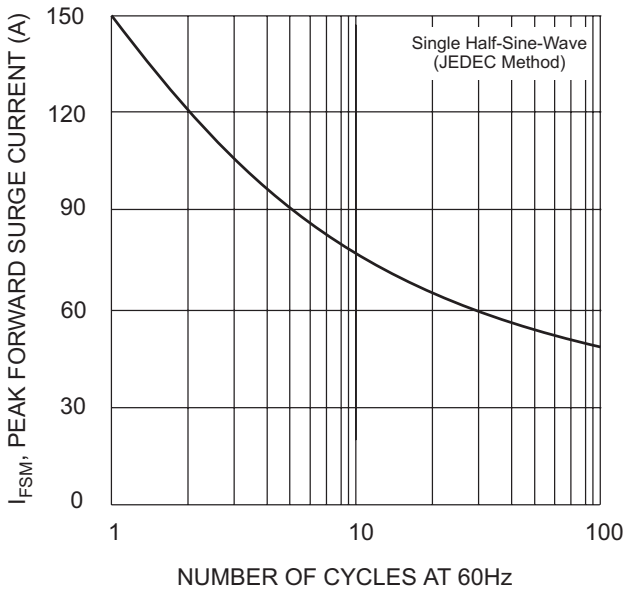

Fig. 3 Max Non-Repetitive Peak Fwd Surge Current

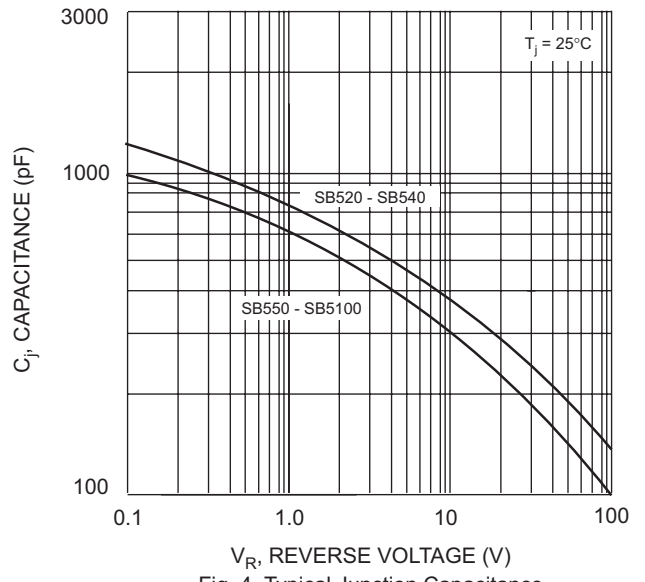

Fig. 4 Typical Junction Capacitance

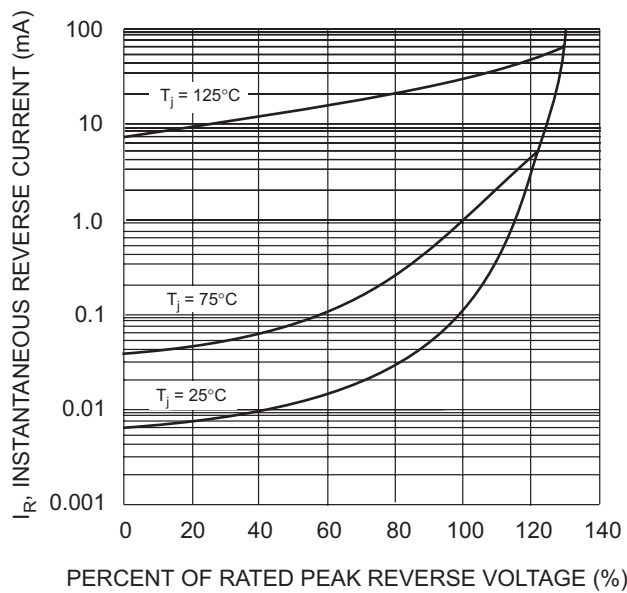
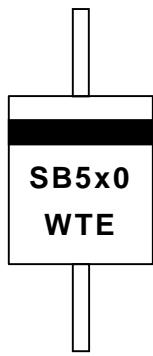

Fig. 5 Typical Reverse Characteristics

MARKING INFORMATION



Cathode = Polarity Band
 SB5x0 = Device Number
 x = 2, 3, 4, 5, 6, 8 or 10
 WTE = Manufacturer's Logo

TAPING SPECIFICATIONS



PACKAGING INFORMATION

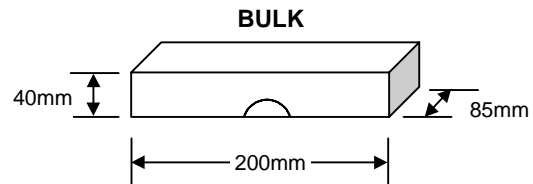
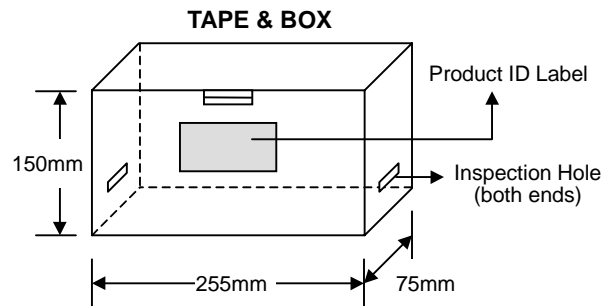

Packaging	Reel Diameter / Box Size (mm)	Quantity (PCS)	Carton Size (mm)	Quantity (PCS)	Approx. Gross Weight (KG)
TAPE & REEL	330	1,200	370 x 370 x 420	6,000	10.0
TAPE & BOX	255 x 75 x 150	1,200	400 x 273 x 415	12,000	17.0
BULK	200 x 85 x 40	500	459 x 214 x 256	12,500	16.0

Note: 1. Paper reel, white or gray color. Core material: plastic or metal.
 2. Components are packed in accordance with EIA standard RS-296-E.

ORDERING INFORMATION

Product No.	Package Type	Shipping Quantity
SB520-T3	DO-201AD	1200/Tape & Reel
SB520-TB	DO-201AD	1200/Tape & Box
SB520	DO-201AD	500 Units/Box
SB530-T3	DO-201AD	1200/Tape & Reel
SB530-TB	DO-201AD	1200/Tape & Box
SB530	DO-201AD	500 Units/Box
SB540-T3	DO-201AD	1200/Tape & Reel
SB540-TB	DO-201AD	1200/Tape & Box
SB540	DO-201AD	500 Units/Box
SB550-T3	DO-201AD	1200/Tape & Reel
SB550-TB	DO-201AD	1200/Tape & Box
SB550	DO-201AD	500 Units/Box
SB560-T3	DO-201AD	1200/Tape & Reel
SB560-TB	DO-201AD	1200/Tape & Box
SB560	DO-201AD	500 Units/Box
SB580-T3	DO-201AD	1200/Tape & Reel
SB580-TB	DO-201AD	1200/Tape & Box
SB580	DO-201AD	500 Units/Box
SB5100-T3	DO-201AD	1200/Tape & Reel
SB5100-TB	DO-201AD	1200/Tape & Box
SB5100	DO-201AD	500 Units/Box

1. Products listed in **bold** are WTE **Preferred** devices.
2. Shipping quantity given is for minimum packing quantity only. For minimum order quantity, please consult the Sales Department.
3. **To order RoHS / Lead Free version (with Lead Free finish), add "-LF" suffix to part number above. For example, SB520-TB-LF.**

Won-Top Electronics Co., Ltd (WTE) has checked all information carefully and believes it to be correct and accurate. However, WTE cannot assume any responsibility for inaccuracies. Furthermore, this information does not give the purchaser of semiconductor devices any license under patent rights to manufacturer. WTE reserves the right to change any or all information herein without further notice.

WARNING: DO NOT USE IN LIFE SUPPORT EQUIPMENT. WTE power semiconductor products are not authorized for use as critical components in life support devices or systems without the express written approval.

Won-Top Electronics Co., Ltd.

No. 44 Yu Kang North 3rd Road, Chine Chen Dist., Kaohsiung, Taiwan

Phone: 886-7-822-5408 or 886-7-822-5410

Fax: 886-7-822-5417

Email: sales@wontop.com

Internet: http://www.wontop.com

We power your everyday.