



## Transient Voltage Suppressors – TVS

WL-CSP0201 Slim-line, General purpose type

**Series/Type:** SD0201SL-GP101  
**Ordering code:** B74121G0050M060  
Date: 2021-02-02  
Version: 2

**Features**

- Bidirectional ESD protection of one I/O line
- ESD protection to IEC 61000-4-2,  $V_{ESD,max} = 24$  kV
- Surge protection to IEC 61000-4-5,  $I_{PP,max} = 8.0$  A
- Very low clamping voltage:  $V_{CL} = 8.0$  V  
( $I_{TLP} = 16$  A,  $t_p = 100$  ns)
- Very low leakage current ( $I_{leak} = 2$  nA at 3.3 V)
- Ultra small package with a height of 0.15 mm

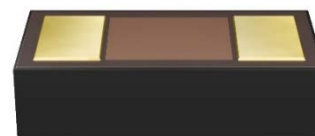
**Applications**

- Cellular handsets
- Laptops
- Tablets
- Wearables
- Network communication devices
- Other portable devices with tight space requirements

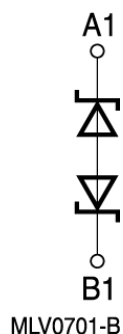
**Schematics**

Pin	Description
A1	I/O Pin
B1	GND

Due to the symmetrical configuration no marking information is needed.

A1 and B1 can be interchanged.

**Maximum ratings**

Rating	Symbol	Value	Unit
Maximum DC working voltage I/O to GND	$V_{RWM}$	5	V
ESD air and contact discharge (acc. to IEC 61000-4-2 standard)	$V_{ESD,max}$	24	kV
Surge (8/20 $\mu$ s) peak pulse current (acc. to IEC 61000-4-5 standard)	$I_{PP,max}$	8	A
Ambient temperature	$T_a$	-40 ... +125	$^{\circ}$ C

**Characteristics ( $T_A = 25\text{ }^\circ\text{C}$ )**

Parameter	Symbol	Conditions	Minimum	Typical	Maximum	Unit
Breakdown voltage	$V_{BR}$	$I_{BR} = 1\text{ mA}$ , I/O to GND	6	6.8	8	V
Leakage current	$I_{leak}$	$V_{RWM} = 3.3\text{ V}$		0.002	0.05	$\mu\text{A}$
	$I_{leak}$	$V_{RWM} = 5\text{ V}$		0.04	0.1	$\mu\text{A}$
Capacitance	$C_j$	$f = 1\text{ MHz}$ , 1.0 V		12		pF
Clamping voltage	$V_{clamp}$	$I_{PP} = 8\text{ A}$ , TLP		7.2		V
	$V_{clamp}$	$I_{PP} = 16\text{ A}$ , TLP		8.0		V
Dynamic resistance	$R_{dyn}$	$I_{PP}$ range: 8 ... 16 A, TLP		0.1		$\Omega$

**Note:** Any operating voltage lower than  $V_{RWM}$  results in lower leakage current.

**Typical I-V characteristics**

TLP I-V curve

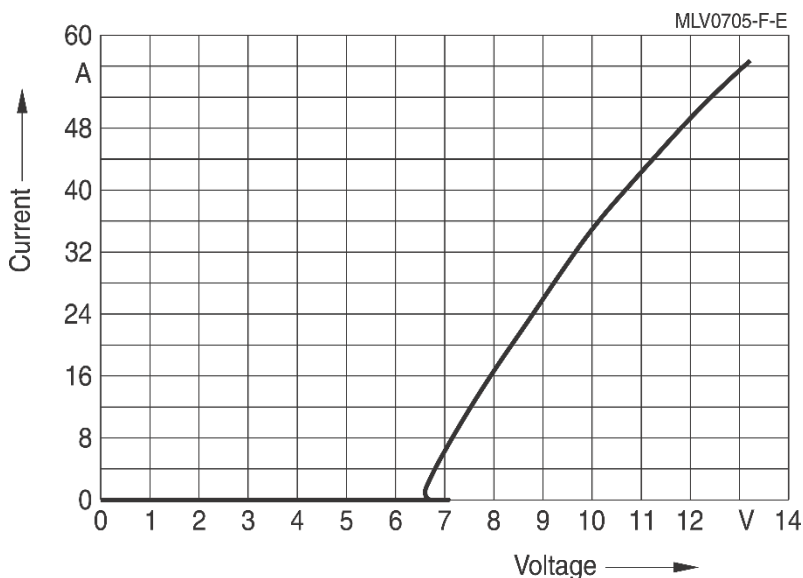
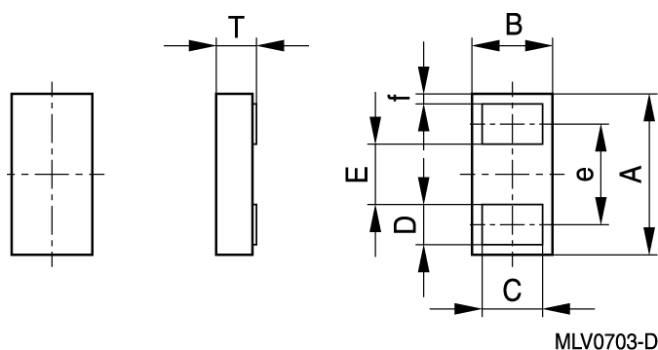

**Dimensional drawing**

**WL-CSP0201 SL**

Symbol	Mean	Tol.
A	0.60	$\pm 0.025$
B	0.30	$\pm 0.025$
T	0.15	$\pm 0.010$
C	0.22	$\pm 0.020$
D	0.13	$\pm 0.020$
E	0.26	(typical)
e	0.39	(typical)
f	0.04	(typical)

Dimensions in mm

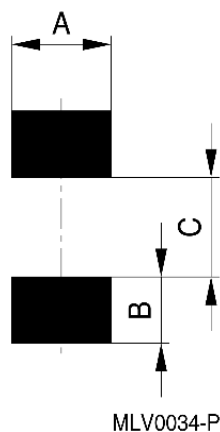
Solder pad finish: Ni /Au

**Recommended reflow soldering footprint**



WL-CSP0201 SL	
Footprint dimensions	
A	0.28
B	0.19
C	0.20

Dimensions in mm

**Recommended soldering profiles**

**Reflow soldering**

Temperature ranges for reflow soldering acc. to IEC 60068-2-58 recommendations.

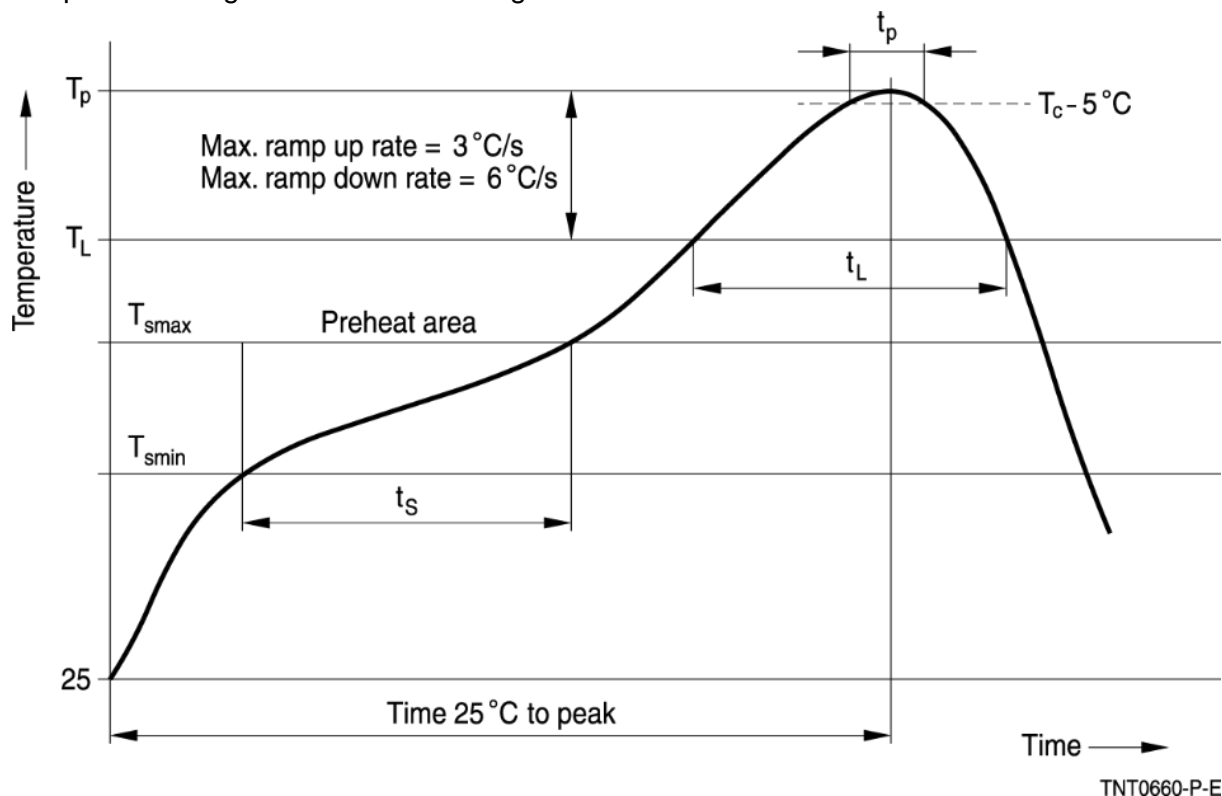

Profile feature	Symbol	Sn-Pb eutectic assembly	Pb-free assembly
Preheat and soak			
– Temperature min.	$T_{smin}$	100 °C	150 °C
– Temperature max.	$T_{smax}$	150 °C	200 °C
– Time	$t_{smin}$ to $t_{smax}$	60 ... 120 s	60 ... 120 s
Average ramp-up rate	$T_{smax}$ to $T_p$	3 °C/s max.	3 °C/s max.
Liquidous temperature	$T_L$	183 °C	217 °C
Time at liquidous	$t_L$	40 ... 150 s	40 ... 150 s
Peak package body temperature	$T_p^{1)}$	215 ... 260 °C	235 ... 260 °C
Time ( $t_p$ ) above ( $T_p - 5$ °C )	$t_p$	10 ... 40 s	10 ... 40 s
Average ramp-down rate	$T_p$ to $T_{smax}$	6 °C/s max.	6 °C/s max.
Time 25 °C to peak temperature		maximum 8 min	maximum 8 min

1) Depending on package thickness

**Note:** All temperatures refer to topside of the package, measured on the package body surface.

Number of reflow cycles: 3

Iron soldering should be avoided, hot air methods are recommended for repair purposes.

## Soldering guidelines

### Recommended solder

The use of no-clean solder products is recommended. In any case mild, non-activated fluxes should be used. Flux residues after soldering should be minimized.

### Storage conditions

In order to maintain solderability the components must be stored in a non-corrosive atmosphere. Humidity, temperature and container materials are critical factors.

Do not store the components where they are exposed to heat or direct sunlight. Otherwise the packing material may be deformed or the components may stick together, causing problems during mounting. After opening the factory seals, such as polyvinyl-sealed packages, use the components as soon as possible.

The components should be left in the original packing. Touching the metallization of unsoldered components may change their soldering properties.

- Storage temperature: -25 ... +45 °C
- Relative humidity: <75% annual average, <95% on max. 30 days in a year, dew precipitation and wetness are inadmissible.

Solder the components listed in this data sheet after shipment from TDK within 12 months.

### Taping and packaging

- Tape and reel packing according to IEC 60286-3
- Tape material: Cardboard
- Component pitch in tape: 2 mm

### Dimensions and tolerances

Definition	Symbol	Dimension	Definition
Tape width	W	8.0	±0.3

- Package: 8-mm tape
- Packing material: Plastic

### Reel dimensions

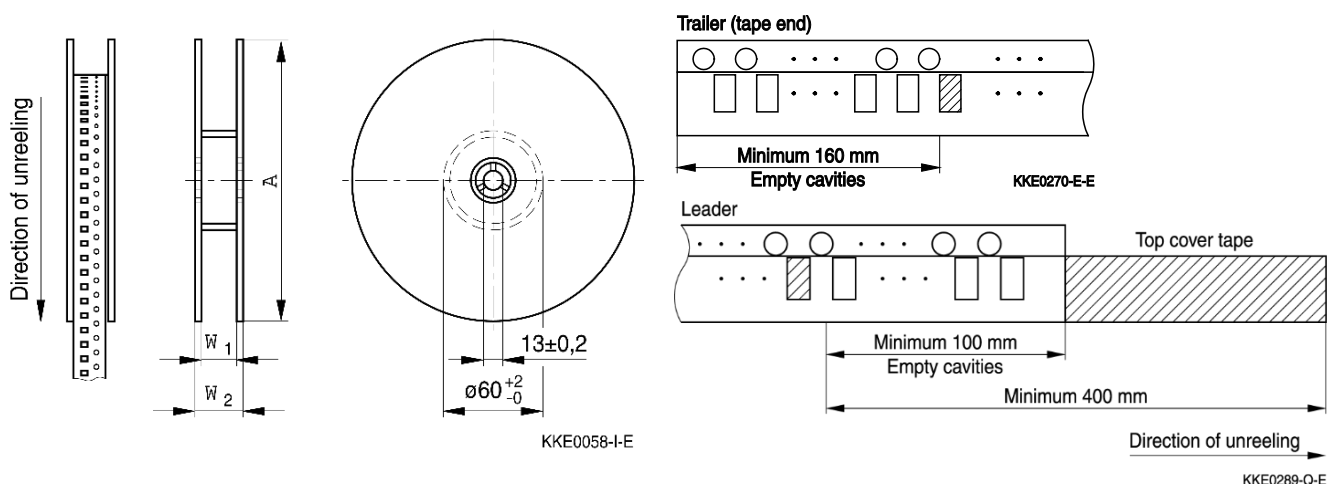

Definition	Symbol	Dimension mm	Tolerance mm
Reel diameter	A	180	+0/-3
Reel width (inside)	W <sub>1</sub>	8.4	+1.5/-0
Reel width (outside)	W <sub>2</sub>	14.4	max.

Packing unit: 20 000 pcs./ reel

## Cautions and warnings

### General

Some parts of this publication contain statements about the suitability of our transient voltage suppressor (TVS) for certain areas of application, including recommendations about incorporation/design-in of these products into customer applications. The statements are based on our knowledge of typical requirements often made of our TVS devices in the particular areas. We nevertheless expressly point out that such statements cannot be regarded as binding statements about the suitability of our TVS components for a particular customer application. As a rule, TDK Electronics is either unfamiliar with individual customer applications or less familiar with them than the customers themselves. For these reasons, it is always incumbent on the customer to check and decide whether the TVS devices with the properties described in the product specification are suitable for use in a particular customer application.

- Do not use TDK Electronics TVS components for purposes not identified in our specifications, application notes and data books.
- Ensure the suitability of a TVS in particular by testing it for reliability during design-in. Always evaluate a TVS component under worst-case conditions.
- Pay special attention to the reliability of TVS devices intended for use in safety-critical applications (e.g. medical equipment, automotive, spacecraft, nuclear power plant).

### Design notes

- Always connect a TVS in parallel with the electronic circuit to be protected.
- Consider maximum rated power dissipation if a TVS has insufficient time to cool down between a number of pulses occurring within a specified isolated time period. Ensure that electrical characteristics do not degrade.
- Consider derating at higher operating temperatures. Choose the highest voltage class compatible with derating at higher temperatures.
- Surge currents beyond specified values will puncture a TVS. In extreme cases a TVS will burst.
- If steep surge current edges are to be expected, make sure your design is as low-inductance as possible.
- In some cases the malfunctioning of TVS components or failure before the end of their service life cannot be completely ruled out in the current state of the art, even if they are operated as specified. In applications requiring a very high level of operational safety and especially when the malfunction or failure of a passive electronic component could endanger human life or health (e.g. in accident prevention, life-saving systems, or automotive battery line applications such as clamp 30), ensure by suitable design of the application or other measures (e.g. installation of protective circuitry or redundancy) that no injury or damage is sustained by third parties in the event of such a malfunction or failure.
- Specified values only apply to TVS components that have not been subject to prior electrical, mechanical or thermal damage. The use of TVS devices in line-to-ground applications is therefore not advisable, and it is only allowed together with safety countermeasures like thermal fuses.

## Storage

- Only store TVS in their original packaging. Do not open the package before storage.
- Storage conditions in original packaging: temperature  $-25$  to  $+45^{\circ}\text{C}$ , relative humidity  $\leq 75\%$  annual average, maximum  $95\%$ , dew precipitation is inadmissible.
- Do not store TVS devices where they are exposed to heat or direct sunlight. Otherwise the packaging material may be deformed or TVS may stick together, causing problems during mounting.
- Avoid contamination of the TVS surface during storage, handling and processing.
- Avoid storing TVS devices in harmful environments where they are exposed to corrosive gases for example (SO<sub>x</sub>, Cl).
- Use TVS as soon as possible after opening factory seals such as polyvinyl-sealed packages.
- Solder TVS components after shipment from TDK Electronics within the time specified:
  - TVS with Ni/Au termination, 12 months

## Handling

- Do not drop TVS components and allow them to be chipped.
- Do not touch TVS with your bare hands - gloves are recommended.
- Avoid contamination of the TVS surface during handling.
- Washing processes may damage the product due to the possible static or cyclic mechanical loads (e.g. ultrasonic cleaning). They may cause cracks to develop on the product and its parts, which might lead to reduced reliability or lifetime.

## Mounting

- When TVS devices are encapsulated with sealing material or overmolded with plastic material, electrical characteristics might be degraded and the life time reduced.
- Make sure an electrode is not scratched before, during or after the mounting process.
- Make sure contacts and housings used for assembly with TVS components are clean before mounting.
- The surface temperature of an operating TVS can be higher. Ensure that adjacent components are placed at a sufficient distance from a TVS to allow proper cooling.
- Avoid contamination of the TVS surface during processing.

## Soldering

- Complete removal of flux is recommended to avoid surface contamination that can result in an instable and/or high leakage current.
- Use resin-type or non-activated flux.
- Bear in mind that insufficient preheating may cause cracks.
- Rapid cooling by dipping in solvent is not recommended, otherwise a component may crack.



**Display of ordering codes for TDK Electronics products**

The ordering code for one and the same product can be represented differently in data sheets, data books, other publications, on the company website, or in order-related documents such as shipping notes, order confirmations and product labels. **The varying representations of the ordering codes are due to different processes employed and do not affect the specifications of the respective products.** Detailed information can be found on the Internet under [www.tdk-electronics.tdk.com/orderingcodes](http://www.tdk-electronics.tdk.com/orderingcodes).

## Important notes

The following applies to all products named in this publication:

1. Some parts of this publication contain **statements about the suitability of our products for certain areas of application**. These statements are based on our knowledge of typical requirements that are often placed on our products in the areas of application concerned. We nevertheless expressly point out **that such statements cannot be regarded as binding statements about the suitability of our products for a particular customer application**. As a rule, we are either unfamiliar with individual customer applications or less familiar with them than the customers themselves. For these reasons, it is always ultimately incumbent on the customer to check and decide whether a product with the properties described in the product specification is suitable for use in a particular customer application.
2. We also point out that **in individual cases, a malfunction of electronic components or failure before the end of their usual service life cannot be completely ruled out in the current state of the art, even if they are operated as specified**. In customer applications requiring a very high level of operational safety and especially in customer applications in which the malfunction or failure of an electronic component could endanger human life or health (e.g. in accident prevention or life-saving systems), it must therefore be ensured by means of suitable design of the customer application or other action taken by the customer (e.g. installation of protective circuitry or redundancy) that no injury or damage is sustained by third parties in the event of malfunction or failure of an electronic component.
3. **The warnings, cautions and product-specific notes must be observed.**
4. In order to satisfy certain technical requirements, **some of the products described in this publication may contain substances subject to restrictions in certain jurisdictions (e.g. because they are classed as hazardous)**. Useful information on this will be found in our Material Data Sheets on the Internet ([www.tdk-electronics.tdk.com/material](http://www.tdk-electronics.tdk.com/material)). Should you have any more detailed questions, please contact our sales offices.
5. We constantly strive to improve our products. Consequently, **the products described in this publication may change from time to time**. The same is true of the corresponding product specifications. Please check therefore to what extent product descriptions and specifications contained in this publication are still applicable before or when you place an order.

We also **reserve the right to discontinue production and delivery of products**. Consequently, we cannot guarantee that all products named in this publication will always be available. The aforementioned does not apply in the case of individual agreements deviating from the foregoing for customer-specific products.

6. Unless otherwise agreed in individual contracts, **all orders are subject to our General Terms and Conditions of Supply**.
7. **Our manufacturing sites serving the automotive business apply the IATF 16949 standard**. The IATF certifications confirm our compliance with requirements regarding the quality management system in the automotive industry. Referring to customer requirements and customer specific requirements ("CSR") TDK always has and will continue to have the policy of respecting individual agreements. Even if IATF 16949 may appear to support the acceptance of unilateral requirements, we hereby like to emphasize that **only requirements mutually agreed upon can and will be implemented in our Quality Management System**. For clarification purposes we like to point out that obligations from IATF 16949 shall only become legally binding if individually agreed upon.

## Important notes

8. The trade names EPCOS, CarXield, CeraCharge, CeraDiode, CeraLink, CeraPad, CeraPlas, CSMP, CTVS, DeltaCap, DigiSiMic, ExoCore, FilterCap, FormFit, LeaXield, MiniBlue, MiniCell, MKD, MKK, ModCap, MotorCap, PCC, PhaseCap, PhaseCube, PhaseMod, PhiCap, PowerHap, PQSine, PQvar, SIFERRIT, SIFI, SIKOREL, SilverCap, SIMDAD, SiMic, SIMID, SineFormer, SIOV, ThermoFuse, WindCap, XieldCap are **trademarks registered or pending** in Europe and in other countries. Further information will be found on the Internet at [www.tdk-electronics.tdk.com/trademarks](http://www.tdk-electronics.tdk.com/trademarks).

Release 2020-06