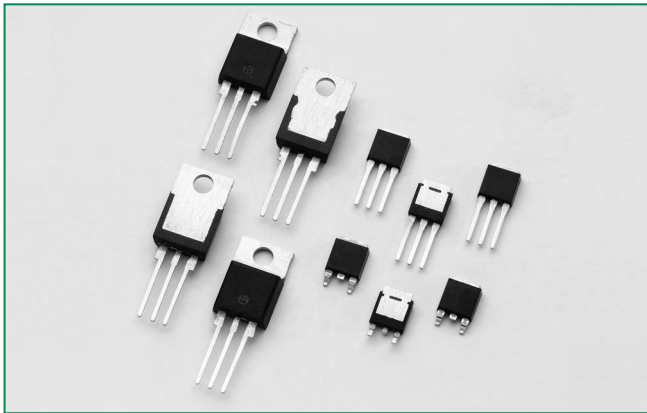


Sxx08xSx & Sxx08x Series



**Description**

Excellent unidirectional switches for phase control applications such as heating and motor speed controls.

Sensitive gate SCRs are easily triggered with microAmps of current as furnished by sense coils, proximity switches, and microprocessors.

Standard phase control SCRs are triggered with few milliamperes of current at less than 1.5V potential.

**Features & Benefits**

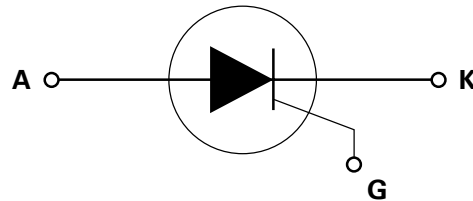
- RoHS compliant
- Glass – passivated junctions
- Voltage capability up to 1000 V
- Surge capability up to 100 A

**Applications**

Typical applications are capacitive discharge systems for strobe lights, nailers, staplers and gas engine ignition. Also controls for power tools, home/brown goods and white goods appliances.

Internally constructed isolated packages are offered for ease of heat sinking with highest isolation voltage.

**Schematic Symbol**



**Agency Approval**

| Agency | Agency File Number |
|--------|--------------------|
|        | L Package: E71639  |

**Main Features**

| Symbol            | Value       | Unit |
|-------------------|-------------|------|
| $I_{T(RMS)}$      | 8           | A    |
| $V_{DRM}/V_{RRM}$ | 400 to 1000 | V    |
| $I_{GT}$          | 0.2 to 15   | mA   |

**Additional Information**



Datasheet



Resources



Samples

**Absolute Maximum Ratings — Sensitive SCRs**

| Symbol       | Parameter                                 | Test Conditions  |                          | Value      | Unit                   |
|--------------|---|--|--------------------------|------------|------------------------|
| $I_{T(RMS)}$ | RMS on-state current                      | Sxx08LSy   | $T_c = 80^\circ\text{C}$ | 8          | A                      |
|              |   | Sxx08RSy<br>Sxx08DSy<br>Sxx08VSy   | $T_c = 95^\circ\text{C}$ |            |                        |
| $I_{T(AV)}$  | Average on-state current                  | Sxx08LSy   | $T_c = 80^\circ\text{C}$ | 5.1        | A                      |
|              |   | Sxx08RSy<br>Sxx08DSy<br>Sxx08VSy   | $T_c = 95^\circ\text{C}$ |            |                        |
| $I_{TSM}$    | Peak non-repetitive surge current         | single half cycle; $f = 50\text{Hz}$ ;<br>$T_J$ (initial) = $25^\circ\text{C}$ |                          | 83         | A                      |
|              |   | single half cycle; $f = 60\text{Hz}$ ;<br>$T_J$ (initial) = $25^\circ\text{C}$ |                          | 100        |                        |
| $I^2t$       | $I^2t$ Value for fusing                   | $t_p = 8.3 \text{ ms}$   |                          | 41         | $\text{A}^2\text{s}$   |
| $di/dt$      | Critical rate of rise of on-state current | $f = 60 \text{ Hz}; T_J = 110^\circ\text{C}$                                   |                          | 70         | $\text{A}/\mu\text{s}$ |
| $I_{GTM}$    | Peak gate current                         | $T_J = 110^\circ\text{C}$  |                          | 1.6        | A                      |
| $P_{G(AV)}$  | Average gate power dissipation            | $T_J = 110^\circ\text{C}$  |                          | 0.4        | W                      |
| $T_{stg}$    | Storage temperature range                 |  |                          | -40 to 150 | $^\circ\text{C}$       |
| $T_J$        | Operating junction temperature range      |  |                          | -40 to 110 | $^\circ\text{C}$       |

Note: xx = voltage, y = sensitivity

**Absolute Maximum Ratings — Standard SCRs**

| Symbol       | Parameter                                 | Test Conditions  |                           | Value      | Unit                   |
|--------------|---|--|---------------------------|------------|------------------------|
| $I_{T(RMS)}$ | RMS on-state current                      | Sxx08L   | $T_c = 100^\circ\text{C}$ | 8          | A                      |
|              |   | Sxx08R<br>Sxx08D<br>Sxx08V   | $T_c = 110^\circ\text{C}$ |            |                        |
| $I_{T(AV)}$  | Average on-state current                  | Sxx08L   | $T_c = 100^\circ\text{C}$ | 5.1        | A                      |
|              |   | Sxx08R<br>Sxx08D<br>Sxx08V   | $T_c = 110^\circ\text{C}$ |            |                        |
| $I_{TSM}$    | Peak non-repetitive surge current         | single half cycle; $f = 50\text{Hz}$ ;<br>$T_J$ (initial) = $25^\circ\text{C}$ |                           | 83         | A                      |
|              |   | single half cycle; $f = 60\text{Hz}$ ;<br>$T_J$ (initial) = $25^\circ\text{C}$ |                           | 100        |                        |
| $I^2t$       | $I^2t$ Value for fusing                   | $t_p = 8.3 \text{ ms}$   |                           | 41         | $\text{A}^2\text{s}$   |
| $di/dt$      | Critical rate-of-rise of on-state current | $f = 60 \text{ Hz}; T_J = 125^\circ\text{C}$                                   |                           | 100        | $\text{A}/\mu\text{s}$ |
| $I_{GM}$     | Peak gate current                         | $T_J = 125^\circ\text{C}$  |                           | 2          | A                      |
| $P_{G(AV)}$  | Average gate power dissipation            | $T_J = 125^\circ\text{C}$  |                           | 0.5        | W                      |
| $T_{stg}$    | Storage temperature range                 |  |                           | -40 to 150 | $^\circ\text{C}$       |
| $T_J$        | Operating junction temperature range      |  |                           | -40 to 125 | $^\circ\text{C}$       |

Note: xx = voltage

**Electrical Characteristics ( $T_J = 25^\circ\text{C}$ , unless otherwise specified) – Sensitive SCRs**

| Symbol    | Test Conditions   |      | Value    |          | Unit             |
|-----------|---|------|----------|----------|------------------|
|           |   |      | Sxx08xS2 | Sxx08xS3 |                  |
| $I_{GT}$  | $V_D = 6V$ $R_L = 100 \Omega$   | MAX. | 200      | 500      | $\mu\text{A}$    |
| $V_{GT}$  | $V_D = 6V$ $R_L = 100 \Omega$   | MAX. | 0.8      |          | V                |
| dv/dt     | $V_D = V_{DRM}$ ; $R_{GK} = 1k\Omega$ ; $T_J = 110^\circ\text{C}$   | TYP. | 8        |          | V/ $\mu\text{s}$ |
| $V_{GD}$  | $V_D = V_{DRM}$ $R_L = 3.3 k\Omega$ $T_J = 110^\circ\text{C}$   | MIN. | 0.2      |          | V                |
| $V_{GRM}$ | $I_{GR} = 10\mu\text{A}$  | MIN. | 6        |          | V                |
| $I_H$     | $I_T = 20\text{mA}$ (initial)   | MAX. | 6        | 8        | mA               |
| $t_q$     | $I_T = 2\text{A}$ ; $t_p = 50\mu\text{s}$ ; $dv/dt = 5\text{V}/\mu\text{s}$ ; $di/dt = -30\text{A}/\mu\text{s}$ | MAX. | 50       | 45       | $\mu\text{s}$    |
| $t_{gt}$  | $I_G = 2 \times I_{GT}$ $PW = 15\mu\text{s}$ $I_T = 12\text{A}$   | TYP. | 4        | 5        | $\mu\text{s}$    |

Note: xx = voltage x = package

**Electrical Characteristics ( $T_J = 25^\circ\text{C}$ , unless otherwise specified) – Standard SCRs**

| Symbol   | Test Conditions   |       |      | Value  | Unit             |
|----------|---|-------|------|--------|------------------|
|          |   |       |      | Sxx08x |                  |
| $I_{GT}$ | $V_D = 12V$ $R_L = 60 \Omega$   |       | MAX. | 15     | mA               |
| $V_{GT}$ | $V_D = 12V$ $R_L = 60 \Omega$   |       | MAX. | 1.5    | V                |
| dv/dt    | $V_D = V_{DRM}$ ; gate open; $T_J = 100^\circ\text{C}$  | 400V  | MIN. | 350    | V/ $\mu\text{s}$ |
|          |   | 600V  |      | 300    |                  |
|          |   | 800V  |      | 250    |                  |
|          |   | 1000V |      | 100    |                  |
|          | $V_D = V_{DRM}$ ; gate open; $T_J = 125^\circ\text{C}$  | 400V  |      | 250    |                  |
|          |   | 600V  |      | 225    |                  |
|          | 800V  | 200   |      |        |                  |
| $V_{GD}$ | $V_D = V_{DRM}$ $R_L = 3.3 k\Omega$ $T_J = 125^\circ\text{C}$   |       | MIN. | 0.2    | V                |
| $I_H$    | $I_T = 200\text{mA}$ (initial)  |       | MAX. | 30     | mA               |
| $t_q$    | $I_T = 2\text{A}$ ; $t_p = 50\mu\text{s}$ ; $dv/dt = 5\text{V}/\mu\text{s}$ ; $di/dt = -30\text{A}/\mu\text{s}$ |       | MAX. | 35     | $\mu\text{s}$    |
| $t_{gt}$ | $I_G = 2 \times I_{GT}$ $PW = 15\mu\text{s}$ $I_T = 16\text{A}$   |       | TYP. | 2      | $\mu\text{s}$    |

Note: xx = voltage x = package

**Static Characteristics**

| Symbol                    | Test Conditions                              |          |                           | Value      | Unit |      |               |
|---------------------------|--|----------|---------------------------|------------|------|------|---------------|
| $V_{TM}$                  | $I_T = 16\text{A}$ ; $t_p = 380 \mu\text{s}$ |          |                           | MAX.       | 1.6  | V    |               |
| $I_{DRM} / I_{RRM}$       | $V_{DRM} = V_{RRM}$                          | Sxx08xyy | $T_J = 25^\circ\text{C}$  | 400 - 600V | MAX. | 5    | $\mu\text{A}$ |
|                           |  |          | $T_J = 110^\circ\text{C}$ | 400 - 600V |      | 250  |               |
|                           |  | Sxx08x   | $T_J = 25^\circ\text{C}$  | 400 - 800V |      | 10   |               |
|                           |  |          |                           | 1000V      |      | 20   |               |
|                           |  |          | $T_J = 100^\circ\text{C}$ | 400 - 800V |      | 200  |               |
|                           |  |          |                           | 1000V      |      | 3000 |               |
| $T_J = 125^\circ\text{C}$ | 400 - 800V                                   | 500      |                           |            |      |      |               |

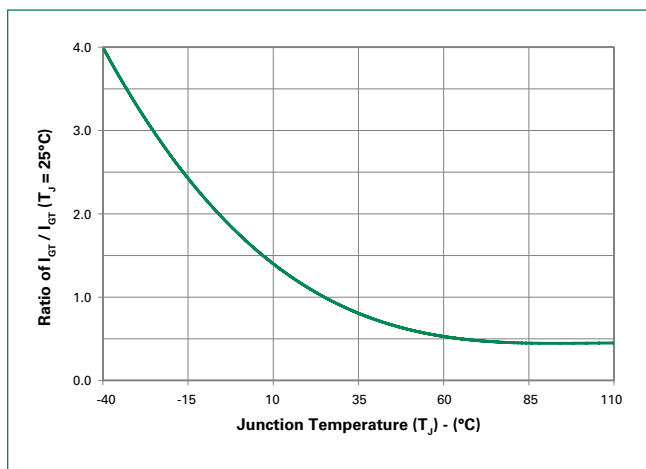
Note: xx = voltage, x = package, yy = sensitivity

**Thermal Resistances**

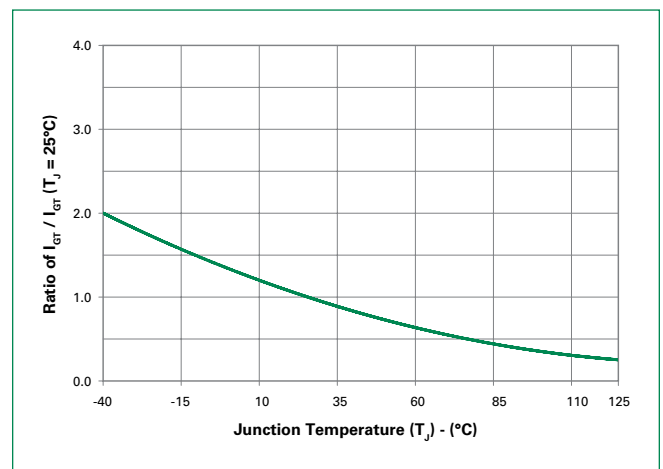
| Symbol            | Parameter             | Value    | Unit |      |
|-------------------|-----------------------|----------|------|------|
| $R_{\theta(J-C)}$ | Junction to case (AC) | Sxx08RSy | 1.8  | °C/W |
|                   |                       | Sxx08LSy | 3.4  |      |
|                   |                       | Sxx08VSy | 2.1  |      |
|                   |                       | Sxx08DSy | 1.5  |      |
|                   |                       | Sxx08R   | 1.8  |      |
|                   |                       | Sxx08L   | 3.4  |      |
|                   |                       | Sxx08V   | 2.0  |      |
|                   |                       | Sxx08D   | 1.5  |      |
| $R_{\theta(J-A)}$ | Junction to ambient   | Sxx08RSy | 40   | °C/W |
|                   |                       | Sxx08LSy | 65   |      |
|                   |                       | Sxx08VSy | 85   |      |
|                   |                       | Sxx08R   | 40   |      |
|                   |                       | Sxx08L   | 50   |      |
|                   |                       | Sxx08V   | 70   |      |

Note: xx = voltage, y = sensitivity

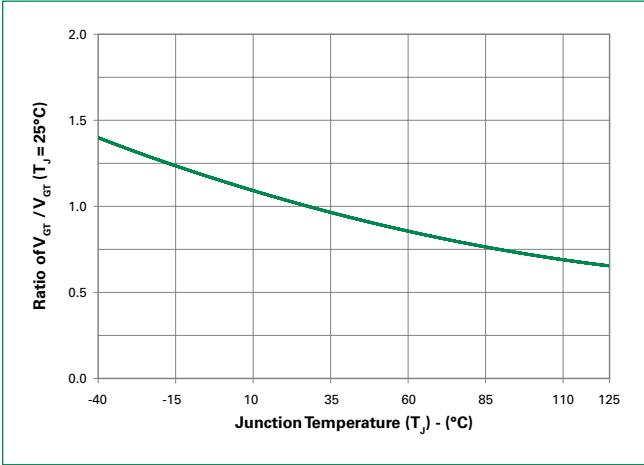
**Figure 1: Normalized DC Gate Trigger Current vs. Junction Temperature (Sensitive SCR)**



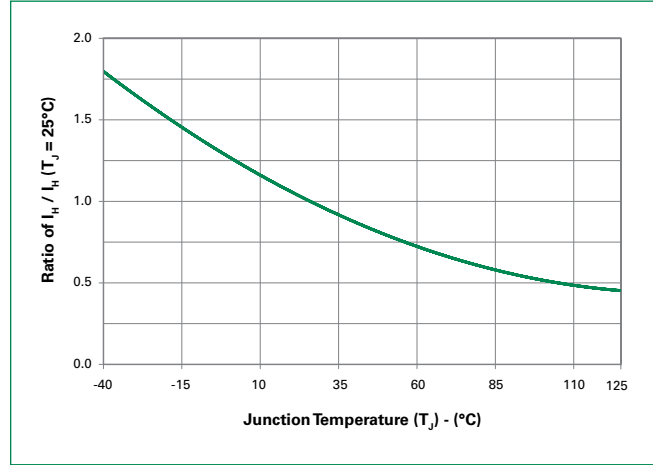
**Figure 2: Normalized DC Gate Trigger Current vs. Junction Temperature (Standard SCR)**



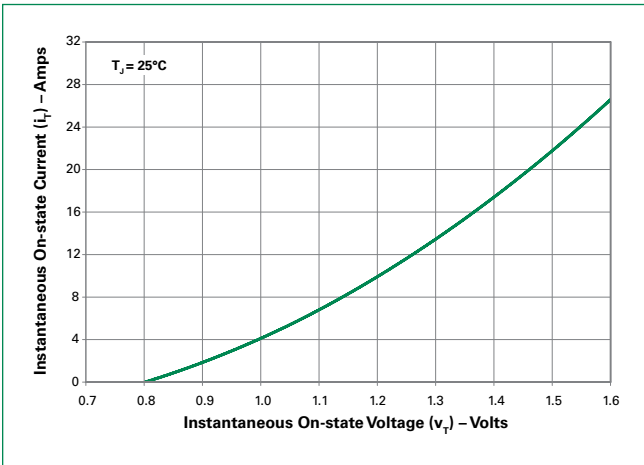
**Figure 3: Normalized DC Gate Trigger Voltage vs. Junction Temperature**



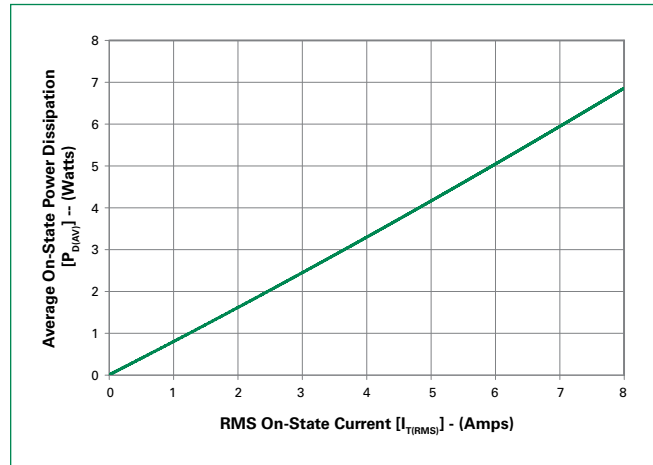
**Figure 4: Normalized DC Holding Current vs. Junction Temperature**



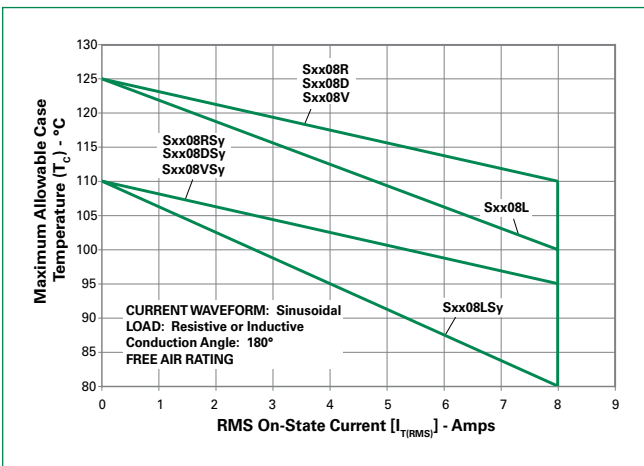
**Figure 5: On-State Current vs. On-State Voltage (Typical)**



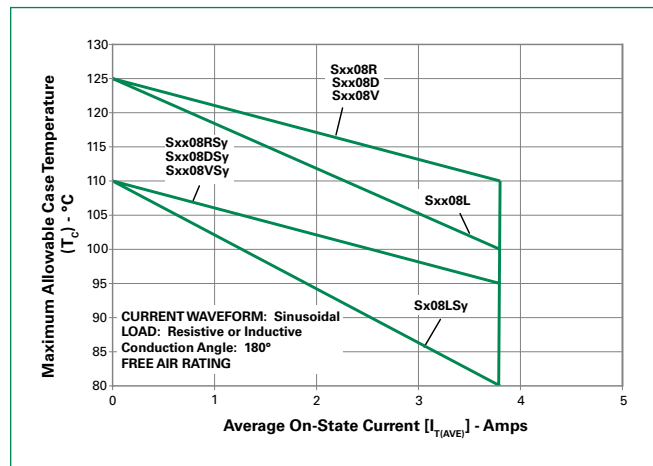
**Figure 6: Power Dissipation (Typical) vs. RMS On-State Current**



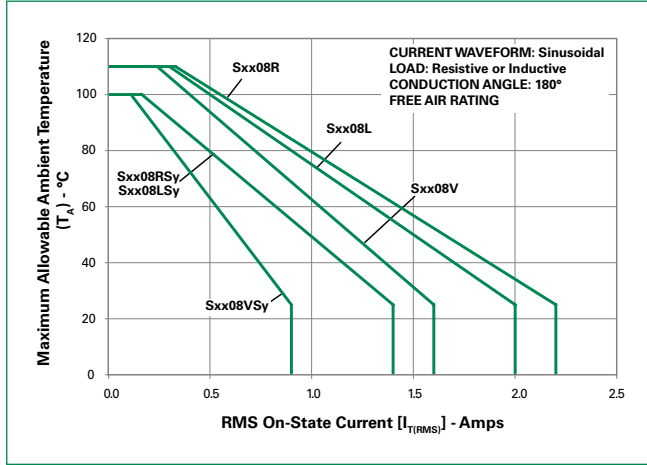
**Figure 7: Maximum Allowable Case Temperature vs. RMS On-State Current**



**Figure 8: Maximum Allowable Case Temperature vs. Average On-State Current**

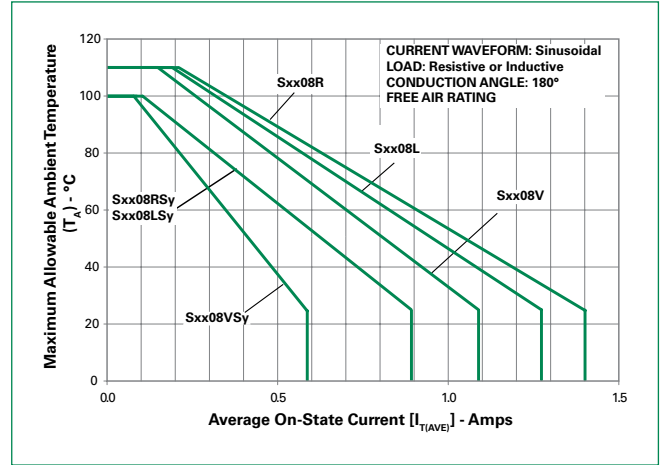


**Figure 9: Maximum Allowable Ambient Temperature vs. RMS On-State Current**

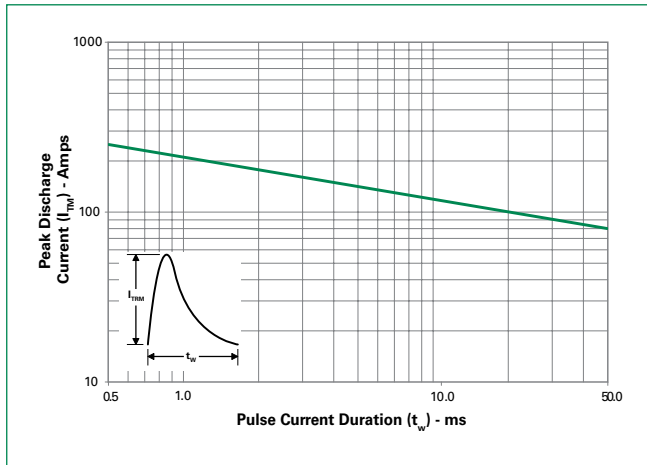


Note: xx = voltage, y = sensitivity

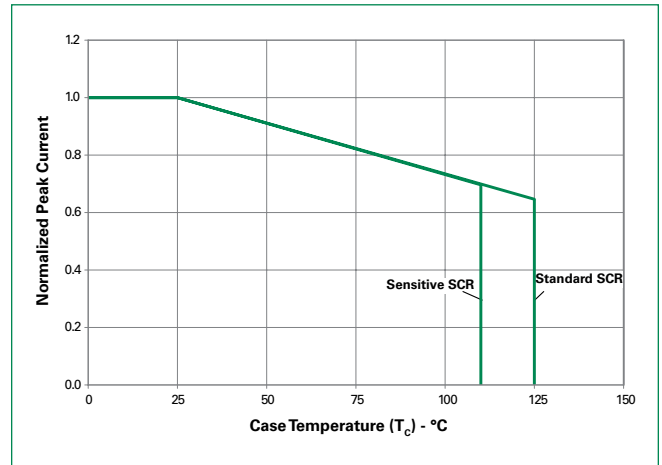
**Figure 10: Maximum Allowable Ambient Temperature vs. Average On-State Current**



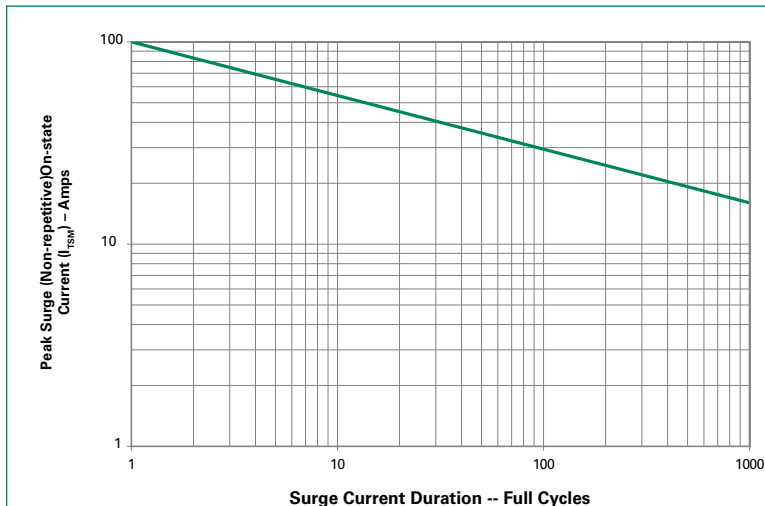
**Figure 11: Peak Capacitor Discharge Current**



**Figure 12: Peak Capacitor Discharge Current Derating**



**Figure 13: Surge Peak On-State Current vs. Number of Cycles**



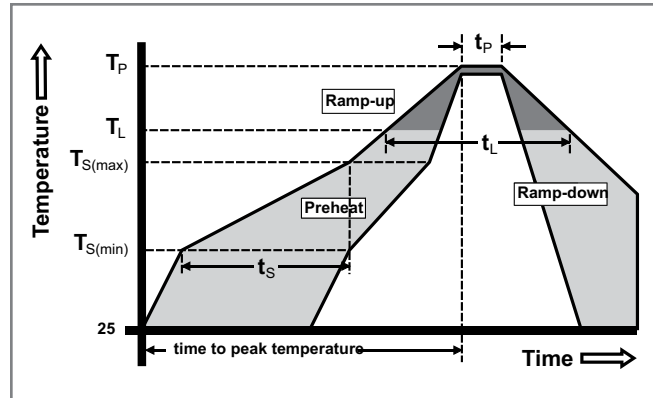
SUPPLY FREQUENCY: 60 Hz Sinusoidal  
LOAD: Resistive  
RMS On-State Current: [I<sub>T(RMS)</sub>]: Maximum Rated Value at Specified Case Temperature

Notes:

1. Gate control may be lost during and immediately following surge current interval.
2. Overload may not be repeated until junction temperature has returned to steady-state rated value.

**Soldering Parameters**

|  |                                    |                         |
|--|------------------------------------|-------------------------|
| Reflow Condition                                       |                                    | Pb – Free assembly      |
| Pre Heat   | - Temperature Min ( $T_{s(min)}$ ) | 150°C                   |
|  | - Temperature Max ( $T_{s(max)}$ ) | 200°C                   |
|  | - Time (min to max) ( $t_s$ )      | 60 – 180 secs           |
| Average ramp up rate (Liquidus Temp) ( $T_L$ ) to peak |                                    | 5°C/second max          |
| $T_{s(max)}$ to $T_L$ - Ramp-up Rate                   |                                    | 5°C/second max          |
| Reflow   | - Temperature ( $T_L$ ) (Liquidus) | 217°C                   |
|  | - Temperature ( $t_l$ )            | 60 – 150 seconds        |
| Peak Temperature ( $T_p$ )                             |                                    | 260 <sup>+0/-5</sup> °C |
| Time within 5°C of actual peak Temperature ( $t_p$ )   |                                    | 20 – 40 seconds         |
| Ramp-down Rate   |                                    | 5°C/second max          |
| Time 25°C to peak Temperature ( $T_p$ )                |                                    | 8 minutes Max.          |
| Do not exceed  |                                    | 280°C                   |



**Physical Specifications**

|                        |   |
|------------------------|---|
| <b>Terminal Finish</b> | 100% Matte Tin-plated   |
| <b>Body Material</b>   | UL recognized epoxy meeting flammability classification 94V-0 |
| <b>Lead Material</b>   | Copper Alloy  |

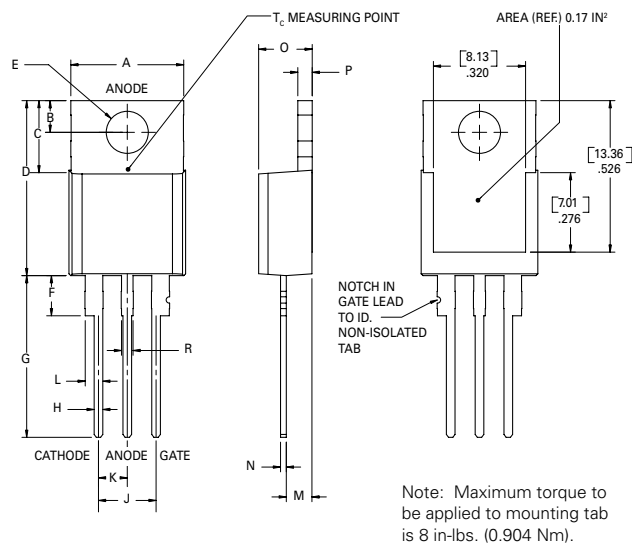
**Design Considerations**

Careful selection of the correct device for the application's operating parameters and environment will go a long way toward extending the operating life of the Thyristor. Good design practice should limit the maximum continuous current through the main terminals to 75% of the device rating. Other ways to ensure long life for a power discrete semiconductor are proper heat sinking and selection of voltage ratings for worst case conditions. Overheating, overvoltage (including dv/dt), and surge currents are the main killers of semiconductors. Correct mounting, soldering, and forming of the leads also help protect against component damage.

**Environmental Specifications**

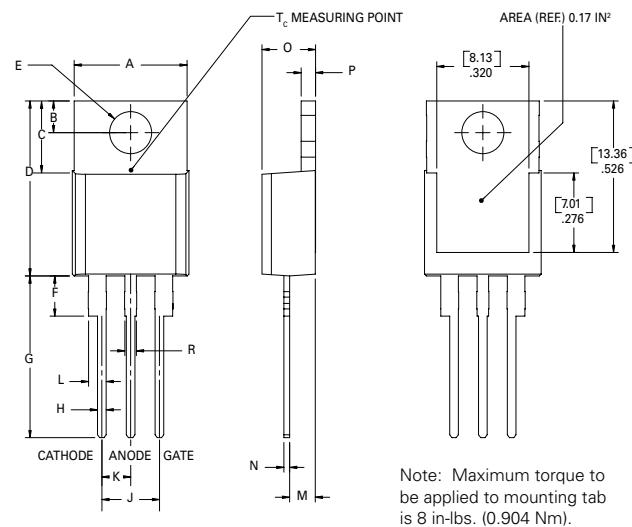
| Test                             | Specifications and Conditions  |
|----------------------------------|--|
| <b>AC Blocking</b>               | MIL-STD-750, M-1040, Cond A Applied Peak AC voltage @ 125°C for 1008 hours |
| <b>Temperature Cycling</b>       | MIL-STD-750, M-1051, 100 cycles; -40°C to +150°C; 15-min dwell-time        |
| <b>Temperature/Humidity</b>      | EIA / JEDEC, JESD22-A101 1008 hours; 320V - DC; 85°C; 85% rel humidity     |
| <b>High Temp Storage</b>         | MIL-STD-750, M-1031, 1008 hours; 150°C                                     |
| <b>Low-Temp Storage</b>          | 1008 hours; -40°C  |
| <b>Resistance to Solder Heat</b> | MIL-STD-750 Method 2031  |
| <b>Solderability</b>             | ANSI/J-STD-002, category 3, Test A   |
| <b>Lead Bend</b>                 | MIL-STD-750, M-2036 Cond E   |

**Dimensions — TO-220AB (R-Package) — Non-Isolated Mounting Tab Common with Center Lead**



| Dimension | Inches |       | Millimeters |       |
|-----------|--------|-------|-------------|-------|
|           | Min    | Max   | Min         | Max   |
| A         | 0.380  | 0.420 | 9.65        | 10.67 |
| B         | 0.105  | 0.115 | 2.67        | 2.92  |
| C         | 0.230  | 0.250 | 5.84        | 6.35  |
| D         | 0.590  | 0.620 | 14.99       | 15.75 |
| E         | 0.142  | 0.147 | 3.61        | 3.73  |
| F         | 0.110  | 0.130 | 2.79        | 3.30  |
| G         | 0.540  | 0.575 | 13.72       | 14.61 |
| H         | 0.025  | 0.035 | 0.64        | 0.89  |
| J         | 0.195  | 0.205 | 4.95        | 5.21  |
| K         | 0.095  | 0.105 | 2.41        | 2.67  |
| L         | 0.060  | 0.075 | 1.52        | 1.91  |
| M         | 0.085  | 0.095 | 2.16        | 2.41  |
| N         | 0.018  | 0.024 | 0.46        | 0.61  |
| O         | 0.178  | 0.188 | 4.52        | 4.78  |
| P         | 0.045  | 0.060 | 1.14        | 1.52  |
| R         | 0.038  | 0.048 | 0.97        | 1.22  |

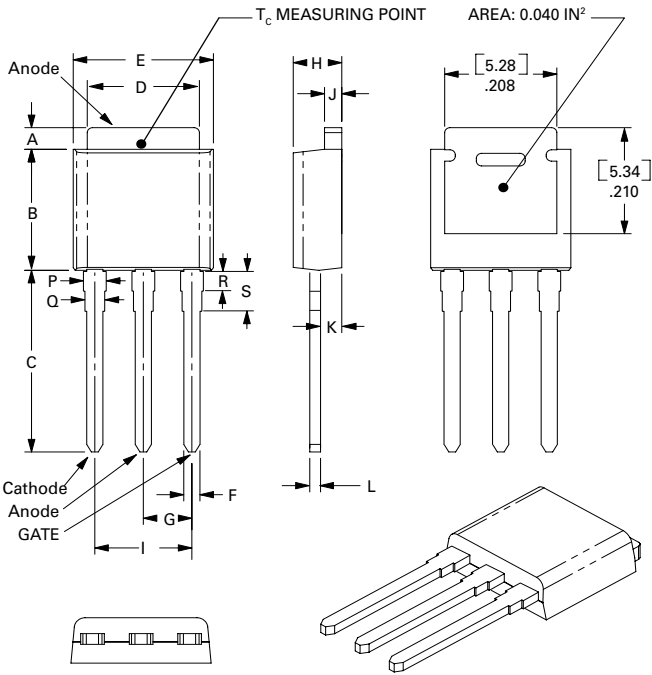
**Dimensions — TO-220AB (L-Package) — Isolated Mounting Tab**



| Dimension | Inches |       | Millimeters |       |
|-----------|--------|-------|-------------|-------|
|           | Min    | Max   | Min         | Max   |
| A         | 0.380  | 0.420 | 9.65        | 10.67 |
| B         | 0.105  | 0.115 | 2.67        | 2.92  |
| C         | 0.230  | 0.250 | 5.84        | 6.35  |
| D         | 0.590  | 0.620 | 14.99       | 15.75 |
| E         | 0.142  | 0.147 | 3.61        | 3.73  |
| F         | 0.110  | 0.130 | 2.79        | 3.30  |
| G         | 0.540  | 0.575 | 13.72       | 14.61 |
| H         | 0.025  | 0.035 | 0.64        | 0.89  |
| J         | 0.195  | 0.205 | 4.95        | 5.21  |
| K         | 0.095  | 0.105 | 2.41        | 2.67  |
| L         | 0.060  | 0.075 | 1.52        | 1.91  |
| M         | 0.085  | 0.095 | 2.16        | 2.41  |
| N         | 0.018  | 0.024 | 0.46        | 0.61  |
| O         | 0.178  | 0.188 | 4.52        | 4.78  |
| P         | 0.045  | 0.060 | 1.14        | 1.52  |
| R         | 0.038  | 0.048 | 0.97        | 1.22  |

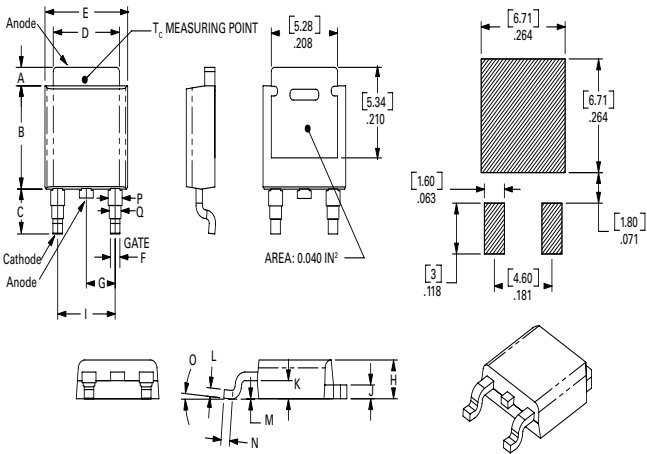


**Dimensions — TO-251AA (V/I-Package) — V/I-PAK Through Hole**



| Dimension | Inches |       |       | Millimeters |      |      |
|-----------|--------|-------|-------|-------------|------|------|
|           | Min    | Typ   | Max   | Min         | Typ  | Max  |
| A         | 0.037  | 0.040 | 0.043 | 0.94        | 1.01 | 1.09 |
| B         | 0.235  | 0.242 | 0.245 | 5.97        | 6.15 | 6.22 |
| C         | 0.350  | 0.361 | 0.375 | 8.89        | 9.18 | 9.53 |
| D         | 0.205  | 0.208 | 0.213 | 5.21        | 5.29 | 5.41 |
| E         | 0.255  | 0.262 | 0.265 | 6.48        | 6.66 | 6.73 |
| F         | 0.027  | 0.031 | 0.033 | 0.69        | 0.80 | 0.84 |
| G         | 0.087  | 0.090 | 0.093 | 2.21        | 2.28 | 2.36 |
| H         | 0.085  | 0.092 | 0.095 | 2.16        | 2.34 | 2.41 |
| I         | 0.176  | 0.180 | 0.184 | 4.47        | 4.57 | 4.67 |
| J         | 0.018  | 0.020 | 0.023 | 0.46        | 0.51 | 0.58 |
| K         | 0.035  | 0.037 | 0.039 | 0.90        | 0.95 | 1.00 |
| L         | 0.018  | 0.020 | 0.023 | 0.46        | 0.52 | 0.58 |
| P         | 0.042  | 0.047 | 0.052 | 1.06        | 1.20 | 1.32 |
| Q         | 0.034  | 0.039 | 0.044 | 0.86        | 1.00 | 1.11 |
| R         | 0.034  | 0.039 | 0.044 | 0.86        | 1.00 | 1.11 |
| S         | 0.074  | 0.079 | 0.084 | 1.86        | 2.00 | 2.11 |

**Dimensions — TO-252AA (D-Package) — D-PAK Surface Mount**



| Dimension | Inches |       |       | Millimeters |      |      |
|-----------|--------|-------|-------|-------------|------|------|
|           | Min    | Typ   | Max   | Min         | Typ  | Max  |
| A         | 0.037  | 0.040 | 0.043 | 0.94        | 1.01 | 1.09 |
| B         | 0.235  | 0.243 | 0.245 | 5.97        | 6.16 | 6.22 |
| C         | 0.106  | 0.108 | 0.113 | 2.69        | 2.74 | 2.87 |
| D         | 0.205  | 0.208 | 0.213 | 5.21        | 5.29 | 5.41 |
| E         | 0.255  | 0.262 | 0.265 | 6.48        | 6.65 | 6.73 |
| F         | 0.027  | 0.031 | 0.033 | 0.69        | 0.80 | 0.84 |
| G         | 0.087  | 0.090 | 0.093 | 2.21        | 2.28 | 2.36 |
| H         | 0.085  | 0.092 | 0.095 | 2.16        | 2.33 | 2.41 |
| I         | 0.176  | 0.179 | 0.184 | 4.47        | 4.55 | 4.67 |
| J         | 0.018  | 0.020 | 0.023 | 0.46        | 0.51 | 0.58 |
| K         | 0.035  | 0.037 | 0.039 | 0.90        | 0.95 | 1.00 |
| L         | 0.018  | 0.020 | 0.023 | 0.46        | 0.51 | 0.58 |
| M         | 0.000  | 0.000 | 0.004 | 0.00        | 0.00 | 0.10 |
| N         | 0.021  | 0.026 | 0.027 | 0.53        | 0.67 | 0.69 |
| O         | 0°     | 0°    | 5°    | 0°          | 0°   | 5°   |
| P         | 0.042  | 0.047 | 0.052 | 1.06        | 1.20 | 1.32 |
| Q         | 0.034  | 0.039 | 0.044 | 0.86        | 1.00 | 1.11 |

### Product Selector

| Part Number | Voltage |      |      |       | Gate Sensitivity | Type          | Package |
|-------------|---------|------|------|-------|------------------|---------------|---------|
|             | 400V    | 600V | 800V | 1000V |                  |               |         |
| Sxx08RS2    | X       | X    |      |       | 0.2mA            | Sensitive SCR | TO-220R |
| Sxx08LS2    | X       | X    |      |       | 0.2mA            | Sensitive SCR | TO-220L |
| Sxx08VS2    | X       | X    |      |       | 0.2mA            | Sensitive SCR | TO-251  |
| Sxx08DS2    | X       | X    |      |       | 0.2mA            | Sensitive SCR | TO-252  |
| Sxx08RS3    | X       | X    |      |       | 0.5mA            | Sensitive SCR | TO-220R |
| Sxx08LS3    | X       | X    |      |       | 0.5mA            | Sensitive SCR | TO-220L |
| Sxx08VS3    | X       | X    |      |       | 0.5mA            | Sensitive SCR | TO-251  |
| Sxx08DS3    | X       | X    |      |       | 0.5mA            | Sensitive SCR | TO-252  |
| Sxx08R      | X       | X    | X    | X     | 15mA             | Standard SCR  | TO-220R |
| Sxx08L      | X       | X    | X    | X     | 15mA             | Standard SCR  | TO-220L |
| Sxx08V      | X       | X    | X    | X     | 15mA             | Standard SCR  | TO-251  |
| Sxx08D      | X       | X    | X    | X     | 15mA             | Standard SCR  | TO-252  |

Note: xx = Voltage

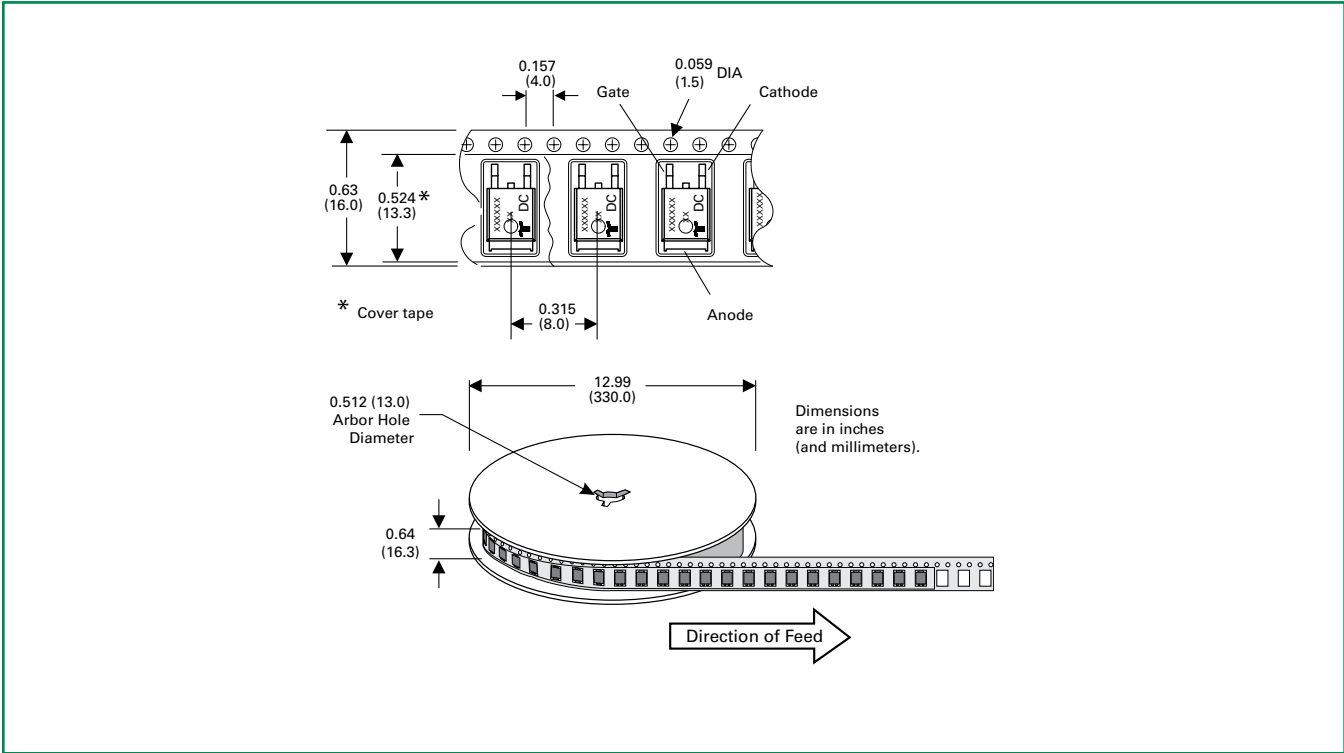
### Packing Options

| Part Number  | Marking    | Weight | Packing Mode     | Base Quantity     |
|--------------|------------|--------|------------------|-------------------|
| Sxx08L/RyyTP | Sxx08L/Ryy | 2.2 g  | Tube             | 500 (50 per tube) |
| Sxx08DyyTP   | Sxx08Dyy   | 0.3 g  | Tube             | 750 (75 per tube) |
| Sxx08DyyRP   | Sxx08Dyy   | 0.3 g  | Embossed Carrier | 2500              |
| Sxx08VyyTP   | Sxx08Vyy   | 0.4 g  | Tube             | 750 (75 per tube) |
| Sxx08L/RTP   | Sxx08L/R   | 2.2 g  | Tube             | 500 (50 per tube) |
| Sxx08DTP     | Sxx08D     | 0.3 g  | Tube             | 750 (75 per tube) |
| Sxx08DRP     | Sxx08D     | 0.3 g  | Embossed Carrier | 2500              |
| Sxx08VTP     | Sxx08V     | 0.4 g  | Tube             | 750 (75 per tube) |

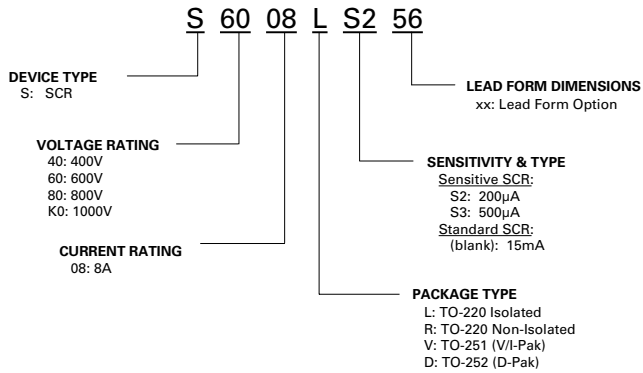
Note: xx = Voltage; yy = Sensitivity

**TO-252 Embossed Carrier Reel Pack (RP) Specifications**

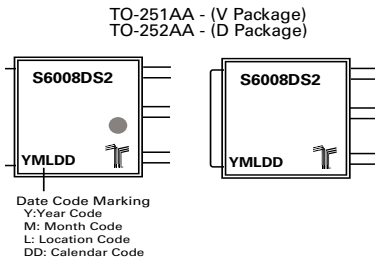
Meets all EIA-481-2 Standards



**Part Numbering System**



**Part Marking System**



**TO-220 AB - (L and R Package)**

