

# μA111 • μA311

## VOLTAGE COMPARATORS

### FAIRCHILD LINEAR INTEGRATED CIRCUITS

**GENERAL DESCRIPTION** — the μA111 and μA311 are monolithic, low input current Voltage Comparators, each constructed using the Fairchild Planar\* epitaxial process. The μA111 series operates from the single 5 V integrated circuit logic supply to the standard ±15 V operational amplifier supplies. The μA111 series is intended for a wide range of applications including driving lamps or relays and switching voltages up to 50 V at currents as high as 50 mA. The output stage is compatible with RTL, DTL, TTL and MOS logic. The input stage current can be raised to increase input slew rate.

- **LOW INPUT BIAS CURRENT** — 150 nA MAX (111), 250 nA MAX (311)
- **LOW INPUT OFFSET CURRENT** — 20 nA MAX (111), 50 nA MAX (311)
- **DIFFERENTIAL INPUT VOLTAGE** — ±30 V
- **POWER SUPPLY VOLTAGE SINGLE 5.0 V SUPPLY TO ±15 V**
- **OFFSET VOLTAGE NULL CAPABILITY**
- **STROBE CAPABILITY**

**ABSOLUTE MAXIMUM RATINGS**

Voltage Between V+ and V- Terminals	36 V
Output to V- (μA111)	50 V
Output to V- (μA311)	40 V
Ground to V-	30 V
Differential Input Voltage	±30 V
Input Voltage (Note 1)	±15 V
Internal Power Dissipation (Note 2)	500 mW
Output Short Circuit Duration	10 s
Storage Temperature Range (Metal Can and Hermetic Mini DIP)	-65°C to +150°C
(Molded Mini DIP)	-55°C to +125°C
Operating Temperature Range	
Military (μA111)	-55°C to +125°C
Commercial (μA311)	0°C to +70°C

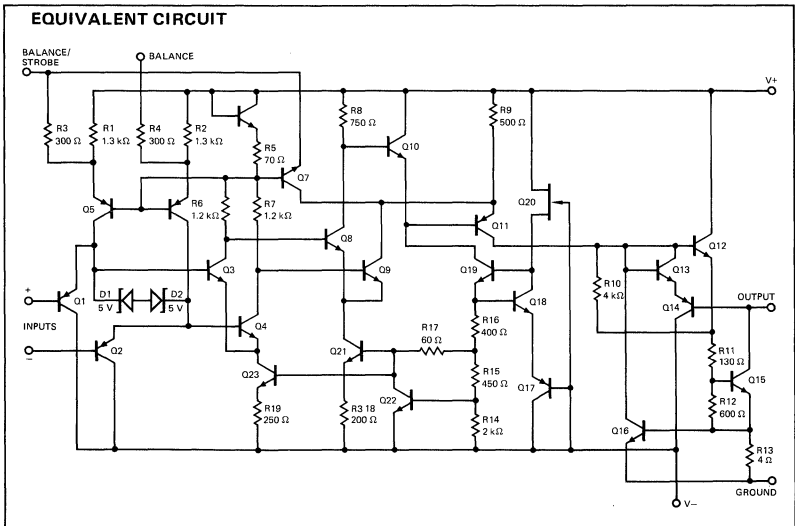

**CONNECTION DIAGRAMS**  
**8-PIN METAL CAN**  
(TOP VIEW)

PACKAGE OUTLINE 5S  
PACKAGE CODE H

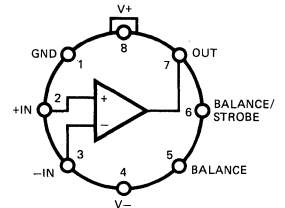

**ORDER INFORMATION**

TYPE	PART NO.
μA111	μA111HM
μA311	μA311HC

**8-PIN MINI DIP**  
(TOP VIEW)

PACKAGE OUTLINE 9T 6T  
PACKAGE CODE T R

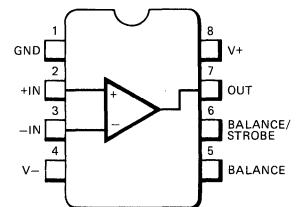

**ORDER INFORMATION**

TYPE	PART NO.
μA111	μA111RM
μA311	μA311RC
μA311	μA311TC

\*Planar is a patented Fairchild process

$\mu$ A111

**ELECTRICAL CHARACTERISTICS:**  $V_S = \pm 15$  V,  $T_A = -55^\circ\text{C}$  to  $+125^\circ\text{C}$  unless otherwise specified, Note 3.

CHARACTERISTICS	CONDITIONS	MIN	TYP	MAX	UNITS
Input Offset Voltage (Note 4)	$T_A = 25^\circ\text{C}$ , $R_S \leq 50$ k $\Omega$		0.7	3.0	mV
Input Offset Current (Note 4)	$T_A = 25^\circ\text{C}$		4.0	10	nA
Input Bias Current	$T_A = 25^\circ\text{C}$		60	100	nA
Voltage Gain	$T_A = 25^\circ\text{C}$		200		V/mV
Response Time (Note 5)	$T_A = 25^\circ\text{C}$		200		ns
Saturation Voltage	$V_{IN} \leq -5$ mV, $I_{OUT} = 50$ mA $T_A = 25^\circ\text{C}$		0.75	1.5	V
Strobe On Current	$T_A = 25^\circ\text{C}$		3.0		mA
Output Leakage Current	$V_{IN} \geq 5$ mV, $V_{OUT} = 35$ V $T_A = 25^\circ\text{C}$		0.2	10	nA
Input Offset Voltage (Note 4)	$R_S \leq 50$ k $\Omega$			4.0	mV
Input Offset Current (Note 4)				20	nA
Input Bias Current				150	nA
Input Voltage Range			$\pm 14$		V
Saturation Voltage	$V^+ \geq 4.5$ V, $V^- = 0$ $V_{IN} \leq -6$ mV, $I_{SINK} \leq 8$ mA		0.23	0.4	V
Output Leakage Current	$V_{IN} \geq 5$ mV, $V_{OUT} = 35$ V		0.1	0.5	$\mu$ A
Positive Supply Current	$T_A = 25^\circ\text{C}$		5.1	6.0	mA
Negative Supply Current	$T_A = 25^\circ\text{C}$		4.1	5.0	mA

$\mu$ A311

**ELECTRICAL CHARACTERISTICS:**  $V_S = \pm 15$  V,  $T_A = 0^\circ\text{C}$  to  $+70^\circ\text{C}$  unless otherwise specified, Note 3.

CHARACTERISTICS	CONDITIONS	MIN	TYP	MAX	UNITS
Input Offset Voltage (Note 4)	$T_A = 25^\circ\text{C}$ , $R_S \leq 50$ k $\Omega$		2.0	7.5	mV
Input Offset Current (Note 4)	$T_A = 25^\circ\text{C}$		6.0	50	nA
Input Bias Current	$T_A = 25^\circ\text{C}$		100	250	nA
Voltage Gain	$T_A = 25^\circ\text{C}$		200		V/mV
Response Time (Note 5)	$T_A = 25^\circ\text{C}$		200		ns
Saturation Voltage	$V_{IN} \leq -10$ mV, $I_{OUT} = 50$ mA $T_A = 25^\circ\text{C}$		0.75	1.5	V
Strobe On Current	$T_A = 25^\circ\text{C}$		3.0		mA
Output Leakage Current	$V_{IN} \geq 10$ mV, $V_{OUT} = 35$ V $T_A = 25^\circ\text{C}$		0.2	50	nA
Input Offset Voltage (Note 4)	$R_S \leq 50$ k $\Omega$			10	mV
Input Offset Current (Note 4)				70	nA
Input Bias Current				300	nA
Input Voltage Range			$\pm 14$		V
Saturation Voltage	$V^+ \geq 4.5$ V, $V^- = 0$ $V_{IN} \leq -10$ mV, $I_{SINK} \leq 8$ mA		0.23	0.4	V
Positive Supply Current	$T_A = 25^\circ\text{C}$		5.1	7.5	mA
Negative Supply Current	$T_A = 25^\circ\text{C}$		4.1	5.0	mA

NOTES:

1. This rating applies for  $\pm 15$  V supplies. The positive input voltage limit is 30 V above the negative supply. The negative input voltage limit is equal to the negative supply voltage or 30 V below the positive supply, whichever is less.
2. Rating applies to ambient temperatures up to  $70^\circ\text{C}$ . Above  $70^\circ\text{C}$  ambient derate linearly at 6.3 mW/ $^\circ\text{C}$  for metal can; 8.3 mW/ $^\circ\text{C}$  for mini DIP.
3. The offset voltage, offset current and bias current specifications apply for any supply voltage from a single 5 V supply up to  $\pm 15$  V supplies.
4. The offset voltages and offset currents given are the maximum values required to drive the output within a volt of either supply with a 1 mA load. Thus, these parameters define an error band and take into account the worst case effects of voltage gain and input impedance.
5. The response time specified (see definitions) is for a 100 mV input step with 5 mV overdrive.

TYPICAL PERFORMANCE CURVES FOR  $\mu A111$

INPUT BIAS CURRENT AS A FUNCTION OF TEMPERATURE

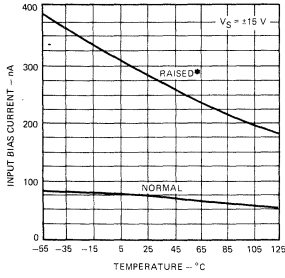

INPUT OFFSET CURRENT AS A FUNCTION OF TEMPERATURE

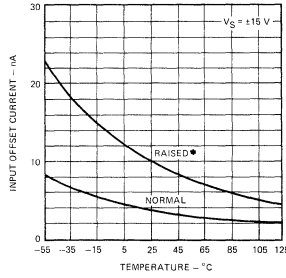

OFFSET VOLTAGE AS A FUNCTION OF INPUT RESISTANCE

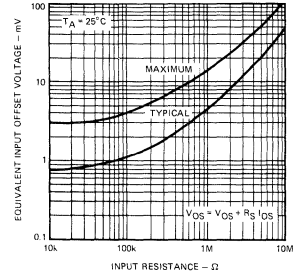

• Pins 5,6 and 8 are shorted.

INPUT BIAS CURRENT AS A FUNCTION OF DIFFERENTIAL INPUT VOLTAGE

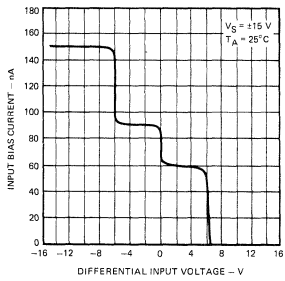

COMMON MODE LIMITS AS A FUNCTION OF TEMPERATURE

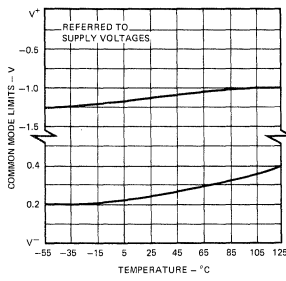

OUTPUT VOLTAGE AS A FUNCTION OF DIFFERENTIAL INPUT VOLTAGE

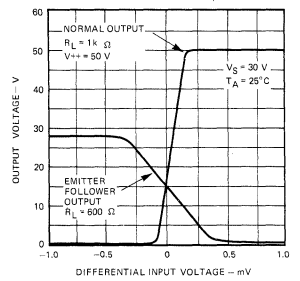

OUTPUT SATURATION VOLTAGE AS A FUNCTION OF OUTPUT CURRENT

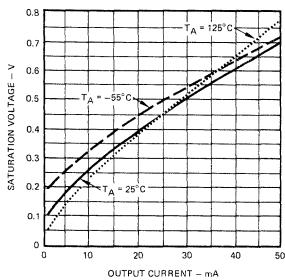

SUPPLY CURRENT AS A FUNCTION OF TEMPERATURE

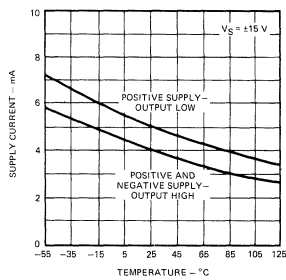

LEAKAGE CURRENTS AS A FUNCTION OF TEMPERATURE

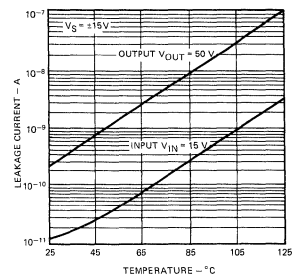

TYPICAL PERFORMANCE CURVES FOR  $\mu A311$

INPUT BIAS CURRENT AS A FUNCTION OF TEMPERATURE

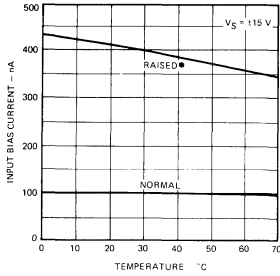

INPUT OFFSET CURRENT AS A FUNCTION OF TEMPERATURE

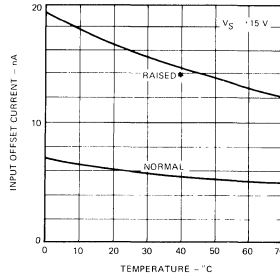

OFFSET VOLTAGE AS A FUNCTION OF INPUT RESISTANCE

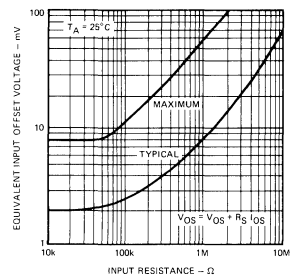

\*Pins 5, 6 and 8 are shorted.

INPUT BIAS CURRENT AS A FUNCTION OF DIFFERENTIAL INPUT VOLTAGE

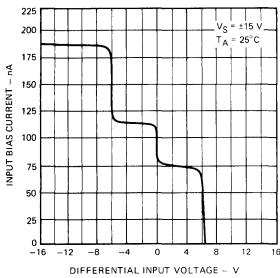

COMMON MODE LIMITS AS A FUNCTION OF TEMPERATURE

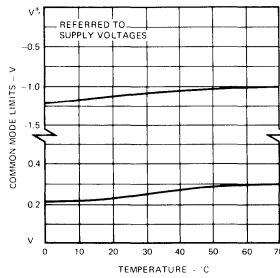

OUTPUT VOLTAGE AS A FUNCTION OF DIFFERENTIAL INPUT VOLTAGE

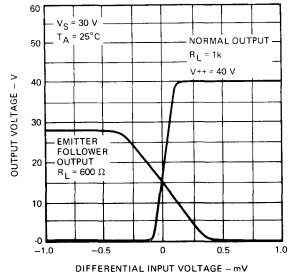

SATURATION VOLTAGE AS A FUNCTION OF CURRENT

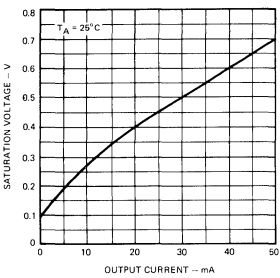

SUPPLY CURRENT AS A FUNCTION OF TEMPERATURE

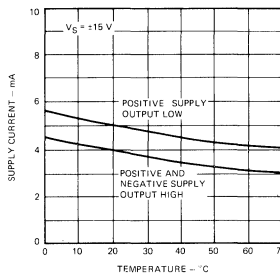

LEAKAGE CURRENT AS A FUNCTION OF TEMPERATURE

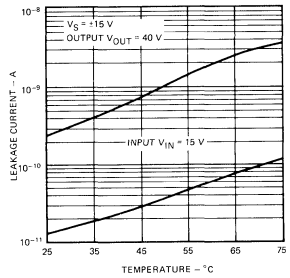

TYPICAL APPLICATIONS

OFFSET NULL CIRCUIT

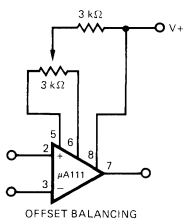

STROBE CIRCUIT

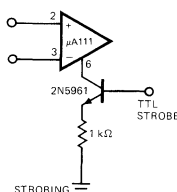

INCREASING INPUT STAGE CURRENT\*

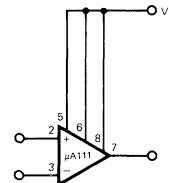

\*Increases typical common mode slew rate from 7.0 V/μs to 18 V/μs.

TYPICAL APPLICATIONS (Cont'd)

ADJUSTABLE LOW VOLTAGE REFERENCE SUPPLY

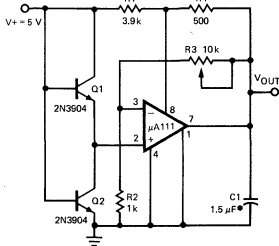

•Solid tantalum

POSITIVE PEAK DETECTOR

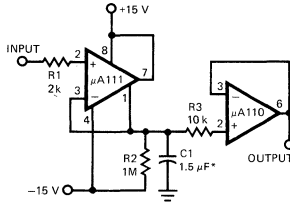

•Solid tantalum

ZERO CROSSING DETECTOR DRIVING MOS LOGIC

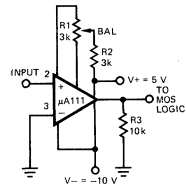

NEGATIVE PEAK DETECTOR

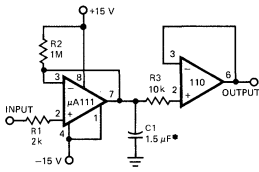

•Solid tantalum

DIGITAL TRANSMISSION ISOLATOR

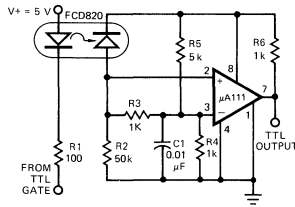

STROBING OF BOTH INPUT AND OUTPUT STAGES

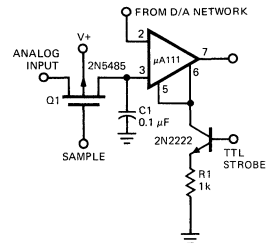

•Typical input current is 50 pA with inputs strobed off.

PRECISION PHOTODIODE COMPARATOR

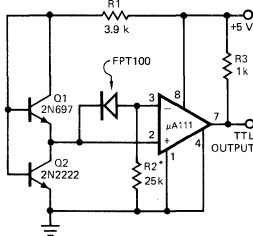

•R2 sets the comparison level.

At comparison, the photodiode has less than 5 mV across it, decreasing leakages by an order of magnitude.

RELAY DRIVER WITH STROBE

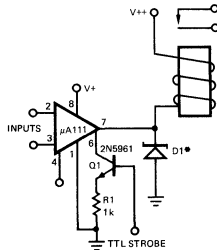

•Absorbs inductive kickback of relay and protects IC from severe voltage transients on V++ line.

SWITCHING POWER AMPLIFIER

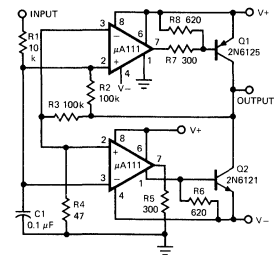

SWITCHING POWER AMPLIFIER

